



Schlage **Omnia**[™]

Fire Rated Smart Lock

Discover more at schlage.com.au/omnia or schlage.co.nz/omnia















Easy access with the Schlage Breeze app

No keys? No problem! With the Schlage Omnia™ Smart Lock, access and control to your apartment or office is a breeze.

Simply pair your Schlage Omnia™ Smart Lock with the Schlage Breeze app on your smartphone, or use the touch keypad, access key tags or fingerprint scanner.

Features

- Easy to set up and program using the Schlage Breeze app
- Use voice commands via Google Assistant and Amazon Alexa
- Program and manage access codes for temporary or recurring visitors
- Touch keypad - up to 150 custom pin codes and 150 scheduled pin codes
- Fingerprint scanner - allows up to 300 fingerprints
- Includes 3 key tags - up to 200 additional tags can be programmed
- Easy installation
- Auto locking and passage mode
- Low battery warning signals
- Built-in alarm technology senses potential security breaches at the lock
- Available in Satin Nickel Plate or Matt Black finishes
- Mechanical key override
- 2 year electronic and finish warranty

	Fire rated		Remote access
	Easy installation		Key override
	Access with PIN, key tag or fingerprint		Auto locking
			Voice guides
	Works with Schlage Breeze app		Built-in alarm



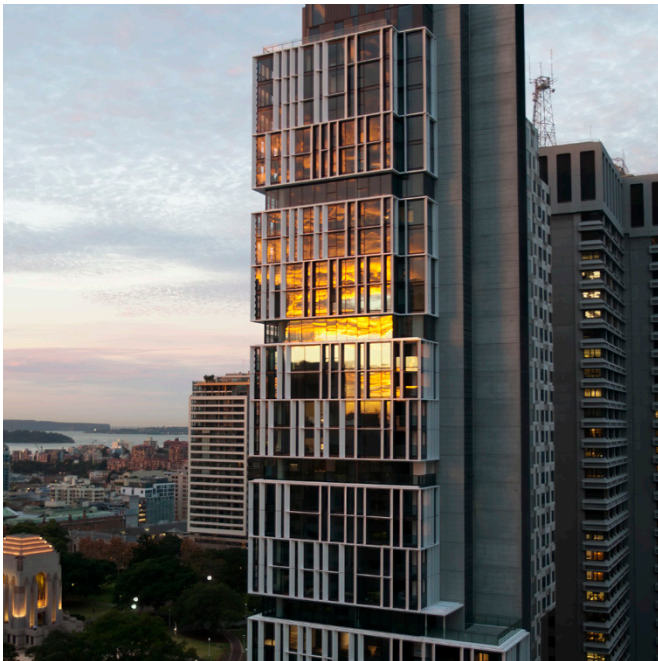

Locking solution

The Schlage Omnia™ Smart Lock is the ideal locking solution for use in apartments and complexes with internal access, where fire rating** is required. These might include multi-residential apartments, office complexes, retirement villages and managed Airbnb dwellings, where access needs to be managed for multiple parties and simplicity is vital.

Enhanced security features

Security features include a built-in alarm that activates if the lock is tampered with, auto locking, and a low battery indicator on the lock, or through notifications on your smartphone via the Schlage Breeze app.

Enhance your security, without compromising on design, with the sleek Schlage Omnia™ Smart Lock.

Convenient access

There are multiple ways of securely accessing the Schlage Omnia™ Smart Lock. The lock comes complete with 3 key tags as well as a key override, or use the keypad or fingerprint scanner.

With built-in Bluetooth, the Schlage Breeze app allows access of the lock through your smartphone. Set up access codes for trusted friends and family or send electronic codes to provide temporary or recurring access. For remote access to your lock, pair your lock with the Schlage Wi-Fi Bridge (BZ100). Send access codes or be alerted if your lock has been tampered with, all from wherever you are.

Convenient access, with high security and dependability is critical in today's smarter way of living.

Easy to install and get connected

The Schlage Omnia™ Smart Lock is easy to install with no wiring or complicated spare parts. Simply follow the step by step instructions provided with the lock to install. Once the lock is installed, download the Schlage Breeze app on your smartphone for simple connection and programming.



Schlage Wi-Fi Bridge (BZ100) sold separately



Scan here for more information on the Schlage Omnia™ Smart Lock

**Check with fire door manufacturer prior to installation

Hardware Specification	
Materials	Die cast zinc alloy body and lever. SSS internal plate
Finishes	Satin Nickel Plate or Matt Black
Keypad	12 keys with individual LED illumination
Feedback	Voice guidance, audible tones and LED indicators
Lock type	Australian mortice lock or tubular latch (sold separately)
Temperature range	0°C to 50°C
Humidity	0 to 90%, non condensing
Suitable environment	Recommended for internal multi-residential use only
Batteries	4x 1.5V AAA alkaline batteries
Battery life	Approximately 1 year (10 uses per day)
Door thickness	35-60mm
External body dimensions	313mm x 53mm x 28mm (L x W x D)
Internal body dimensions	310mm x 53mm x 3mm (L x W x D)
"Fire Rating	The Schlage Omnia™ Smart Lock has been successfully tested on fire door assemblies in accordance with AS1905 Part1: Fire resistance doorsets. Check with fire door manufacturer prior to installation

Access Specification	
Access methods	Keypad, key tag, fingerprint or Bluetooth app
Bluetooth app	Schlage Breeze
Key override	5-Pin Australian oval cylinder with two keys
Number of users	Unlimited Bluetooth
Key tags	Up to 200
Fingerprints	300
PIN code	150x custom. 150x scheduled
PIN code length	4-9 digits
Verification time	<1s
Type	3 key tags

Lock Functions	
Low battery alarm	Yes
Built-in alarm technology	Yes
Incorrect PIN code lockout alarm	Yes
Passage mode	Yes (via app)
One-time password	Yes
Remote unlocking	Yes (via Schlage Wi-Fi Bridge BZ100)
Create PIN codes remotely	Yes (via Schlage Wi-Fi Bridge BZ100)
Bluetooth app	Yes (required for setup)

App Specification	
Platform	iPhone (iOS 8.0 and above) Android (4.3 and above)
Languages	English, Chinese (Mandarin & Cantonese), Japanese, Korean, French, Italian, Spanish, Dutch, Portuguese, Polish, Russian, Vietnamese, Arabic
Device management	Add, delete, modify, check status
Functions	Open/close lock, send mobile credentials, add users and check audit trail

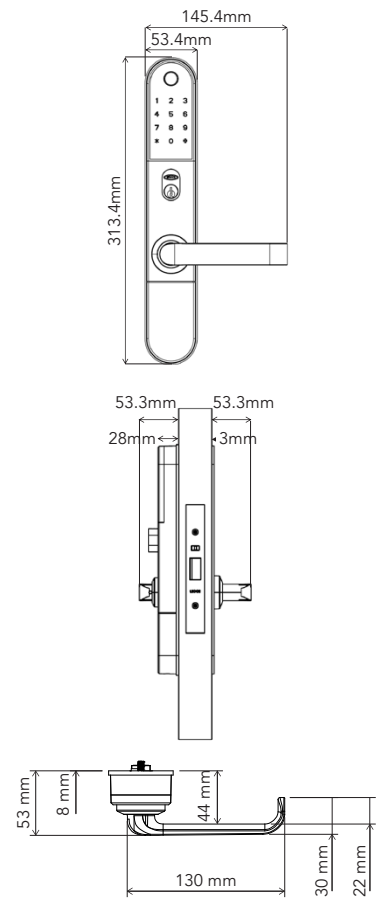

External lock body

Internal lock body

Allegion (Australia) Pty Ltd
 Freephone 1800 098 094
 Email auinfo@allegion.com
www.allegion.com.au

Allegion (New Zealand) Limited
 Freephone 0800 477 869
 Email nzinfo@allegion.com
www.allegion.co.nz



About Allegion™

Allegion (NYSE: ALLE) is a global pioneer in seamless access, with leading brands like CISA®, Interflex®, LCN®, Schlage®, SimonsVoss® and Von Duprin®. Focusing on security around the door and adjacent areas, Allegion secures people and assets with a range of solutions for homes, businesses, schools and institutions. Allegion had US\$2.9 billion in revenue in 2019, and sells products in almost 130 countries.

