





Operating and installation instructions Ovens and cookers



To prevent the risk of accidents or damage to the appliance, it is **essential** to read these instructions before it is installed and used for the first time.

Contents

Warning and Safety instructions	5
Caring for the environment	13
Overview	14
Cooker	14
Oven	15
Oven controls	16
Function selector	17
Temperature selector 	17
Clock/Timer	17
Display.....	17
Sensor controls	17
Features	18
Data plate	18
Items supplied	18
Accessories supplied and available to order.....	18
Safety features	24
PerfectClean treated surfaces.....	25
Cooktop controls.....	25
Before using for the first time	26
Before using for the first time	26
Heating up the oven for the first time.....	27
Overview of functions	28
Energy saving tips	29
Operation	31
Basic operation	31
Pre-heating the oven	31
Clock/Timer	32
Display.....	32
Symbols in the display	32
Sensor controls	32
How to set the time or a duration.....	33
Displaying times/durations	33
When the time/duration has elapsed	33

Using the minute minder 	34
Setting the minute minder	34
Changing the time set for the minute minder	35
Cancelling the minute minder	35
Switching cooking programmes on and off automatically	36
Setting a cooking duration	36
At the end of the cooking duration:	37
Setting a cooking duration and finish time	37
Changing the cooking duration	38
Deleting a cooking duration	38
Deleting a finish time	39
Changing the time of day	39
Changing settings	40
Settings overview	41
Baking	42
Tips on baking	42
Notes on the cooking charts	42
Notes on the oven functions	43
Roasting	44
Tips for roasting	44
Notes on the cooking charts	44
Notes on the oven functions	45
Grilling	46
Tips for grilling	46
Notes on the cooking charts	46
Notes on the oven functions	47
Fan Grill 	48
Grill 	49
Other applications	50
Defrost	50
Low temperature cooking	51
Bottling	52
Drying	54
Frozen food/Ready meals	55
Heat crockery	55
Cleaning and care	56
Unsuitable cleaning agents	56
Removing normal soiling	57
Removing stubborn soiling (excluding the FlexiClip telescopic runners)	58

Contents

Stubborn soiling on the FlexiClip telescopic runners.....	58
Cleaning the catalytic enamelled back panel.....	59
Removing soiling caused by spices, sugar and similar deposits.....	59
Removing oil and grease soiling	59
Removing the door.....	60
Dismantling the door	61
Fitting the door	63
Removing the shelf runners with FlexiClip telescopic runners.....	64
Removing the back panel.....	64
Lowering the top heat/grill element.....	65
Problem solving guide	66
Service	69
Contact in case of fault	69
Warranty	69
Installation	70
Building-in dimensions.....	70
Installation in a tall or base unit.....	70
Side view H 22xx.....	71
Side view H 25xx, H 27xx, H 28xx	72
Connections and ventilation.....	73
Installing the cooker	74
Installing the oven	76
Electrical connection.....	77
Cooking charts	79
Creamed mixture.....	79
Rubbed in mixture	80
Yeast dough	81
Quark dough.....	82
Sponge mixture	82
Choux pastry, puff pastry, meringue.....	83
Savoury snacks	84
Beef	85
Veal.....	86
Pork	87
Lamb, game	88
Poultry, fish.....	89

Warning and Safety instructions

- ▶ For the sake of simplicity, cookers and ovens will subsequently be referred to as the “oven”.

This oven complies with all current local and national safety requirements. However, inappropriate use can lead to personal injury and damage to property.

Read the operating and installation instructions carefully before using the oven for the first time. They contain important information on safety, installation, use and maintenance of the appliance. This prevents both personal injury and damage to the oven.

In accordance with standard IEC 60335-1, Miele expressly and strongly advises that you read and follow the instructions in “Installation”, as well as in the “Warning and Safety instructions”.

Miele cannot be held liable for injury or damage caused by non-compliance with these instructions.

Keep these instructions in a safe place and pass them on to any future owner.

- ▶ The Warning and Safety instructions for the cooktop can be found in the separate operating and installation instructions for the cooktop.

Correct application

- ▶ This oven is designed for domestic use and for use in similar environments by guests in hotel or motel rooms, bed & breakfasts and other typical living quarters. This does not include common/shared facilities or commercial facilities within hotels, motels or bed & breakfasts.
- ▶ The oven is not suitable for outdoor use.
- ▶ The oven is intended for domestic use only to bake, roast, grill, cook, defrost, preserve, and dry food. Any other use is not permitted.

Warning and Safety instructions

- ▶ This oven is not intended for use by persons (including children) with reduced physical, sensory or mental capabilities, or lack of experience and knowledge, unless they are supervised whilst using it. They may only use the oven unsupervised if they have been shown how to use it in a safe manner. They must be able to recognise and understand the dangers of misuse.
- ▶ The oven compartment is equipped with special lamps to cope with particular conditions (e.g. temperature, moisture, chemical resistance, abrasion resistance and vibration). These special lamps must only be used for the purpose for which they are intended. They are not suitable for room lighting.
- ▶ This oven contains 1 light source of energy efficiency class G.

Safety with children

- ▶ Young children must not be allowed to use this appliance.
- ▶ Older children may only use the oven if its operation has been clearly explained to them and they are able to use it safely. They must be able to understand and recognise the possible dangers caused by incorrect operation.
- ▶ Cleaning work may only be carried out by older children under the supervision of an adult.
- ▶ Children should be supervised in the vicinity of the oven. Never allow children to play with the oven.
- ▶ Risk of suffocation from packaging material. Whilst playing, children may become entangled in packaging material (such as plastic wrapping) or pull it over their head with the risk of suffocation. Keep packaging material away from children.
- ▶ Risk of injury caused by hot surfaces. Children's skin is far more sensitive to high temperatures than that of adults. External parts of the oven such as the door glass, control panel and the vent become quite hot.
Do not let children touch the oven when it is in operation.

Warning and Safety instructions

▶ Risk of injury caused by hot surfaces. The cooking zones on cookers also get hot during use. Turn the handles of pots and pans on the cooking zone to the side or the rear so that children cannot pull them down and burn themselves.

▶ Risk of injury from the open door. The oven door can support a maximum weight of 15 kg. Children could injure themselves on an open door.

Do not let children sit on the open door, lean against it or swing on it.

Technical safety

▶ Unauthorised installation, maintenance and repairs (including removal of any cover) can cause considerable danger for the user. Installation, maintenance and repairs must only be carried out by a Miele authorised technician.

▶ Damage to the oven can compromise your safety. Check the oven for visible signs of damage. Do not use a damaged oven.

▶ Temporary or permanent operation with a self-sufficient or non-mains synchronous energy supply system (e.g. isolated networks, back-up systems) is possible. A requirement for the operation is that the energy supply system complies with all current local and national requirements that apply to stand-alone, solar and/or battery systems.

The protective measures provided in the installation and in this Miele product must also be assured in their function and operation in isolated operation or in non-mains synchronous operation, or replaced with equivalent measures in the installation.

▶ The electrical safety of this appliance can only be guaranteed when continuity is complete between it and an effective earthing system. It is essential that this basic safety requirement is present and tested regularly. If in doubt, the electrical installation should be checked by a qualified electrician.

Warning and Safety instructions

- ▶ The connection data (voltage and frequency) on the data plate of the oven must match the mains electricity supply in order to avoid the risk of damage to the oven. Compare this before connecting the appliance to the mains electricity. If in any doubt, consult a qualified electrician.
- ▶ Multi-socket adapters and extension leads do not guarantee the required safety of the appliance. Do not use these to connect the oven to the mains electricity supply.
- ▶ For safety reasons, the oven may only be used when it has been fully installed.
- ▶ This oven must not be installed and operated in mobile installations (e.g. on a ship).
- ▶ Risk of injury due to electric shock. Any contact with live connections or tampering with the electrical or mechanical components of the oven will endanger your safety and may lead to appliance malfunctions. Do not open the oven housing under any circumstances.
- ▶ The manufacturer's warranty will be invalidated if the appliance is not repaired by a Miele approved service technician.
- ▶ Miele can only guarantee the safety of the appliance when original Miele spare parts are used. Faulty components must only be replaced by original spare parts.
- ▶ If the oven is delivered without a mains connection cable, a special cable must be installed by a suitably qualified and competent person (see “Installation - Electrical connection”).
- ▶ If the mains connection cable is damaged, it must be replaced with a special connection cable by a suitably qualified and competent person (see “Installation - Electrical connection”).
- ▶ During installation, maintenance and repair work, e.g. if the oven lighting is faulty, the oven must be completely disconnected from the electricity supply (see “Problem solving guide”). To ensure this:
 - Switch off the mains circuit breaker, or
 - switch off at the wall socket and withdraw the plug. To do this, pull the plug and not the mains connection cable.

Warning and Safety instructions



- ▶ The oven requires a sufficient supply of cool air for efficient operation. Make sure that the supply of cool air is not hindered in any way (e.g. by heat insulation strips fitted in the housing unit). Furthermore, the required supply of cool air must not be excessively heated by other heat sources (e.g. solid fuel stoves).
- ▶ If the oven is built in behind a furniture front (e.g. a door), do not close the furniture door while the oven is in use. Heat and moisture can build up behind the closed furniture door. This can result in damage to the oven, housing unit and floor. Leave the furniture door open until the oven has cooled down completely.

Correct use

- ▶ Risk of injury caused by hot surfaces. The oven gets hot during operation. You could burn yourself on the heating elements, oven compartment, accessories or food. Wear oven gloves when placing food in the oven or removing it, and when adjusting oven shelves etc. in a hot oven.
- ▶ Due to the high temperatures radiated, objects left near the oven could catch fire. Do not use the oven to heat up the room.
- ▶ Oils and fats can ignite if allowed to overheat. Never leave the oven unattended when cooking with oil or fats. Never attempt to put out oil or fat fires with water. Switch the oven off and extinguish the flames by leaving the door closed.
- ▶ Oils and fats can ignite if allowed to overheat. Never leave the cooktop unattended when cooking with oil or fats. Never attempt to put out oil or fat fires with water. Switch the cooktop off and carefully smother the flames on the cooktop with a lid or a fire blanket.
- ▶ Items left on the cooktop could melt or catch fire from residual heat or if the appliance is switched on by mistake. Never use the cooktop as a resting place to store items.
- ▶ Grilling food for excessively long cooking durations can cause it to dry out with the risk of catching fire. Do not exceed the recommended cooking durations.

Warning and Safety instructions

▶ Certain foods dry out quickly and may catch fire due to high grilling temperatures.

Never use a grill function to finish baking bake-off rolls or bread, or to dry flowers or herbs. Instead, use the Fan Plus  or Conventional Heat  function and always ensure this type of procedure is supervised.



▶ If using alcohol in your recipes, please be aware that high temperatures can cause the alcohol to evaporate. The vapour can catch fire on hot heating elements.

▶ When using residual heat to keep food warm, corrosion from high air humidity and condensation can occur in the oven. This can also cause damage to the control panel, worktop and surrounding kitchen furniture. Keep the oven on and select the lowest temperature available for the selected function. The cooling fan will then continue to run and dissipate the moisture.

▶ Food which is stored in the oven compartment or left in it to be kept warm can dry out and the moisture released can lead to corrosion damage in the oven. Always cover food that is left in the oven to keep warm.

▶ An accumulation of heat can cause the enamel on the floor of the oven to crack or flake off.

Never line the floor of the oven compartment with aluminium foil or oven liners.

If you wish to place crockery on the oven floor during cooking, or place crockery on the oven floor to heat it up, you can do so, but only with the Fan Plus  or Eco Fan Heat  function.

▶ The oven compartment floor can become damaged by items being pushed around on it. When placing pots, pans or crockery on the oven compartment floor, ensure that you avoid pushing them around.

▶ Danger of injury caused by steam. Pouring a cold liquid onto a hot surface creates steam, which can cause severe scalding. The sudden temperature change can also cause damage to hot surfaces. Never pour cold liquids directly onto hot surfaces.

Warning and Safety instructions

- ▶ It is important that the temperature in the food being cooked is evenly distributed and sufficiently high. This can be achieved by stirring or turning the food.
- ▶ Plastic dishes that are not suitable for use in an oven will melt and may ignite at high temperatures and damage the oven. Use only plastic containers that are suitable for use in an oven. Follow the manufacturer's instructions.
- ▶ Preserving and heating food in sealed tins will result in an increase in pressure, which can cause them to explode. Do not use tins for preserving or heating food.
- ▶ Risk of injury from the open door. You could bang into the open door or trip over it. Avoid leaving the door open unnecessarily.
- ▶ The door can support a maximum load of 15 kg. Do not lean or sit on an open door, or place heavy items on it. Make sure that nothing gets trapped between the door and the oven compartment. This could damage the oven.

The following applies for stainless steel surfaces:

- ▶ The coated stainless steel surface can be damaged by adhesives and will lose its dirt-repelling properties. Do not use sticky notes, adhesive tape or other types of adhesive on the stainless steel surface.
- ▶ Magnets can cause scratches. Do not use the stainless steel surface as a magnetic notice board.

Cleaning and care

- ▶ Risk of injury due to electric shock. The steam from a steam cleaning appliance could reach electrical components and cause a short circuit. Never use a steam cleaner for cleaning.
- ▶ Scratches on the door glass can cause the glass to break. Do not use abrasive cleaners, hard sponges, brushes or sharp metal tools to clean the door glass.

Warning and Safety instructions

- ▶ The shelf runners can be removed (see “Cleaning and care – Removing the shelf runners with FlexiClip telescopic runners”). Refit the shelf runners correctly.
- ▶ The catalytic enamelled back panel can be removed for cleaning purposes (see “Cleaning and care - Removing the back panel”). Ensure it is correctly fitted after cleaning and never operate the oven without the back panel fitted.
- ▶ In warm, moist environments, there is a higher probability of vermin infestations (e.g. cockroaches). Ensure the oven and the area surrounding it are always kept clean.
Damage caused by vermin is not covered by the warranty.

Accessories

- ▶ Miele cookers may only be combined with cooktops specified by Miele as suitable for use with that appliance (see “Installation - Electrical connection”).
- ▶ Only use original Miele accessories. If other parts are used, warranty, performance and product liability claims will be invalidated.
- ▶ Miele will guarantee to supply functional spare parts for a minimum of 10 years and up to 15 years following the discontinuation of your oven.
- ▶ The Miele gourmet oven dish HUB 5000/HUB 5001 (if available) must not be inserted on shelf level 1. This will damage the oven floor. The lack of clearance will create an accumulation of heat which can cause the enamel to crack or flake off. Never place a Miele oven dish on the upper support of shelf level 1 either as it will not be secured by the non-tip safety notches. As a general rule, use shelf level 2.

Disposal of the packing material

The transport and protective packaging has been selected from materials which are environmentally friendly for disposal, and can normally be recycled.

Recycling the packaging reduces the use of raw materials in the manufacturing process and also reduces the amount of waste in landfill sites. Ensure that any plastic wrappings, bags etc. are disposed of safely and kept out of the reach of babies and young children. Danger of suffocation.

Disposing of your old appliance

Electrical and electronic appliances often contain valuable materials. They also contain specific materials, compounds and components, which were essential for their correct function and safety. These could be hazardous to human health and to the environment if disposed of with your domestic waste or if handled incorrectly. Please do not, therefore, dispose of your old appliance with your household waste.



Please dispose of it at your local community waste collection / recycling centre for electrical and electronic appliances. You are also responsible for deleting any personal data that may be stored on the appliance prior to disposal. Please ensure that your old appliance poses no risk to children while being stored prior to disposal.

Overview

Cooker

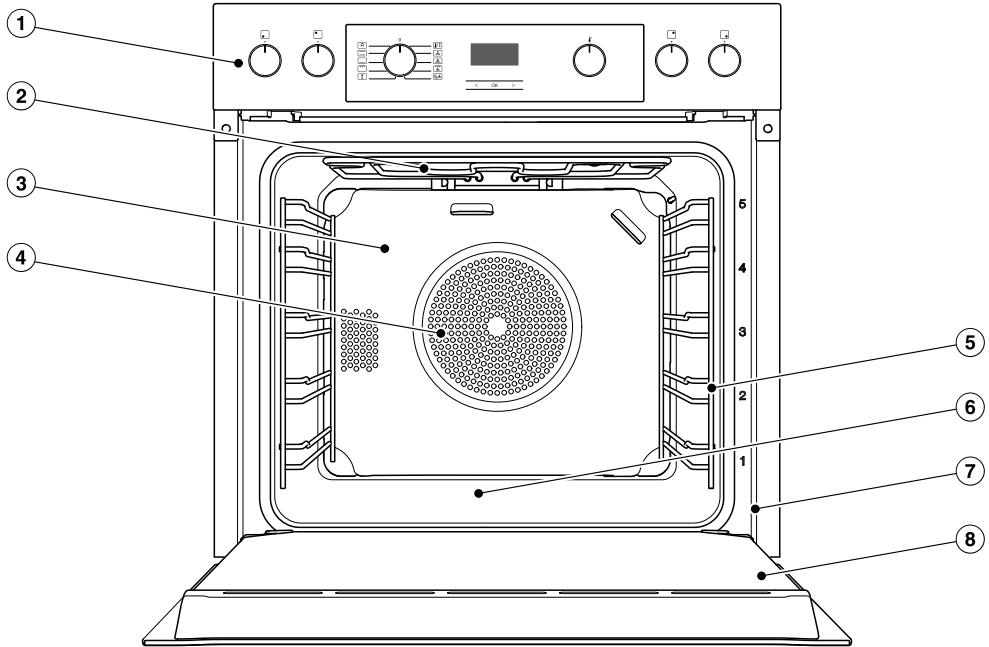

- ① Oven controls, cooktop controls
- ② Top heat/grill element
- ③ Catalytic enamelled back panel
- ④ Air inlet for the fan with ring heating element behind it
- ⑤ Shelf runners with 5 shelf levels
- ⑥ Oven floor with bottom heat element underneath it
- ⑦ Front frame with data plate
- ⑧ Door

Oven

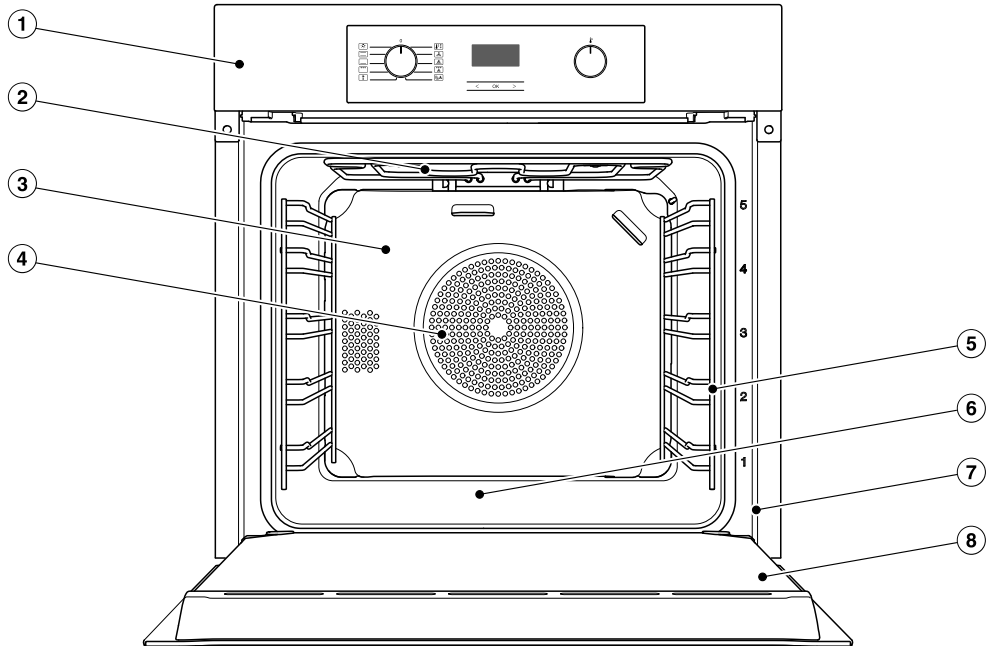

- ① Control panel
- ② Top heat/grill element
- ③ Catalytic enamelled back panel
- ④ Air inlet for the fan with ring heating element behind it
- ⑤ Shelf runners with 5 shelf levels
- ⑥ Oven floor with bottom heat element underneath it
- ⑦ Front frame with data plate
- ⑧ Door

Oven controls

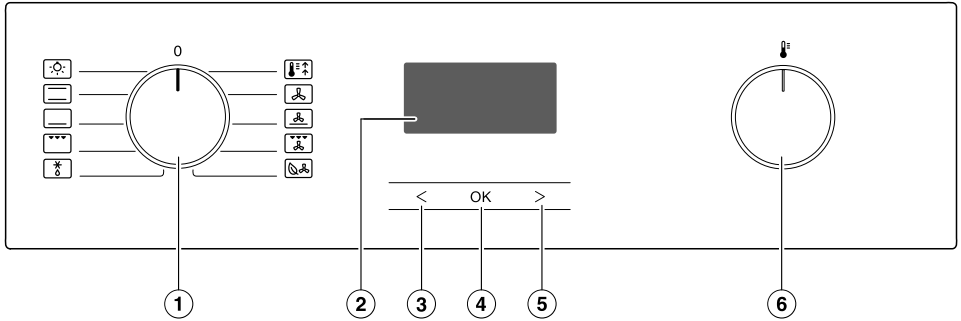

- ① Function selector
For selecting oven functions
- ② Clock/Timer
For displaying the time of day and settings
- ③ < sensor
For changing times and settings
- ④ OK sensor
For calling up functions and saving settings
- ⑤ > sensor
For changing times and settings
- ⑥ Temperature selector
For setting the temperature

Function selector



The function selector is used to select oven functions and to switch on the oven lighting separately.

The function selector can be turned clockwise or anti-clockwise. When the function selector is in the **0** position, it can be retracted by pushing it in.

Oven functions

-  Lighting
-  Conventional Heat
-  Bottom Heat
-  Full Grill
-  Defrost
-  Booster
-  Fan Plus
-  Intensive Bake
-  Fan Grill
-  Eco Fan Heat

Temperature selector

When a function is selected, the recommended temperatures and the  symbol will appear in the display. Use the temperature selector  to change the temperature for cooking processes in 5-degree increments.

The temperature selector  can be turned clockwise or anti-clockwise. It can be retracted in any position by pressing it in.

Clock/Timer

The clock/timer is operated via the **display** and the **<**, **OK** and **>** **sensor controls**.

Display

The display shows the time of day or your settings.

It goes dark if settings are not being entered.

Please refer to “Clock/Timer” for more information.

Sensor controls

The sensor controls respond to the touch of a fingertip. Every touch on the sensors is confirmed by an audible tone.

The keypad tone can be switched off by changing setting *P 4* to status *5* / (see “Clock/Timer - Changing settings”).

Features

A list of the models described in these operating and installation instructions can be found on the back page.

Data plate

The data plate located on the front frame of the oven is visible when the door is open.

The data plate states the model number, the serial number as well as connection data (voltage, frequency and maximum rated load).

Have this information available if you need to contact Miele so that any issues can be rectified as quickly as possible.

Items supplied

- Operating and installation instructions for using the oven
- Screws for fixing the oven to the housing unit
- Various accessories

Accessories supplied and available to order

Features will vary depending on model.

The shelf runners, universal tray and wire rack (or “rack” for short) are supplied as standard with the oven.

Depending on the model, your oven may also come supplied with some of the accessories listed here.

All accessories and cleaning and care products listed in these instructions are designed for Miele ovens.

These are available to order via the Miele online shop or directly from Miele (see the end of this booklet for contact details).

When ordering, please quote the model number of your oven and the reference number of the accessories required.

Shelf runners

Shelf runners for accessories are fitted on either side of the oven cavity for shelf levels .

The shelf level numbers are marked on the front of the oven frame.

Each level consists of 2 rails, one above the other.

Accessories (e.g. the rack) are pushed into the oven between the two rails.

The shelf runners can be removed (see “Cleaning and care – Removing the shelf runners with FlexiClip telescopic runners”).

Baking tray, universal tray and rack with non-tip safety notches

Baking tray HBB 71:

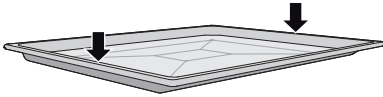

Universal tray HUBB 71:



Rack HBBR 71:



Insert these accessories into the shelf runners between the two rails of a shelf level.

Always place the rack with the loading surface in the lower position and the non-tip safety notches towards the back.

Non-tip safety notches are located on accessories to prevent the trays being pulled out completely when you only wish to pull them out partially. They also prevent trays from tipping.

- The non-tip safety notches are located in the middle of the short sides of the baking tray and universal tray.
- The non-tip safety notches are located towards the back of the short sides of the rack.



If you are using the universal tray with the rack on top, insert the tray between the rails of a shelf runner and the rack will sit on top of it.

FlexiClip telescopic runners HFC 70-C

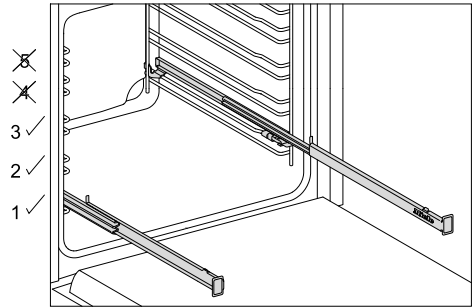

FlexiClip telescopic runners can only be fitted on levels 1, 2 and 3.

The FlexiClip telescopic runners can be drawn right out of the oven to give a good overview of the cooking in progress.

Push the FlexiClip telescopic runners right into the oven compartment before placing accessories on them.

Features

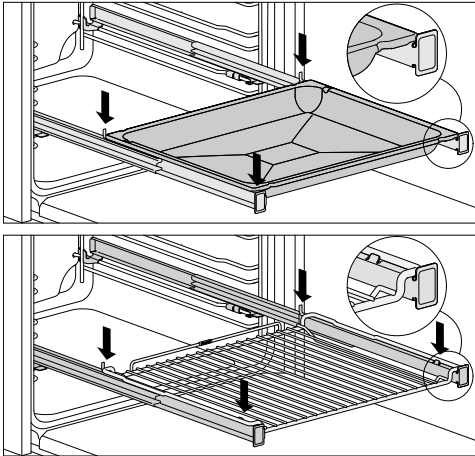

To prevent the risk of accessories sliding off the telescopic runners:

- Make sure that they are sitting securely on their runners in between the stoppers at either end of each runner.
- Always slide the rack onto the FlexiClip telescopic runners with the loading surface facing downwards.

The FlexiClip telescopic runners can support a maximum load of 15 kg.

Because the FlexiClip telescopic runners sit on the top rail of the shelf runners, the gap between the level that the FlexiClip telescopic runners are on and the one above is smaller than if, for instance, racks were fitted on each level. Cooking results will be affected if the gap is too small.

If you need to use more than one baking tray, universal tray or rack at a time:

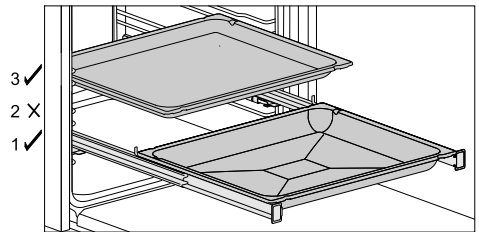

- Place the baking tray, universal tray or rack on the FlexiClip telescopic runners.
- Leave at least one shelf level free between it and any baking tray, universal tray or rack on the FlexiClip telescopic runners above it.

You can use the universal tray together with the rack on the FlexiClip telescopic runners.

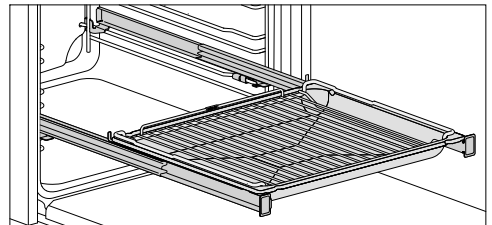

- Place the universal tray together with the rack on the FlexiClip telescopic runners. The rack will automatically slide between the rails of the shelf level above the FlexiClip telescopic runners.
- Leave at least one shelf level free between it and any baking tray, universal tray or rack on the FlexiClip telescopic runners above it.

Fitting the FlexiClip telescopic runners

 Risk of injury caused by hot surfaces.

The oven gets hot during operation. You could burn yourself on the heating elements, the oven compartment, or accessories.

Allow the heating elements, oven compartment and the accessories to cool down before fitting or removing the FlexiClip telescopic runners.

Preferably fit the FlexiClip telescopic runners onto level 1. You can then use them for food which should be cooked on level 2.

Each level of the shelf runners consists of two rails. The FlexiClip telescopic runners are fitted on the upper rail of the two rails that make up a shelf level.

The FlexiClip telescopic runner with the Miele logo is fitted on the right.

When fitting or removing the FlexiClip telescopic runners, do **not** extend them.

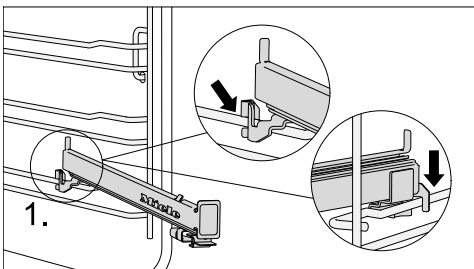

- Hook the FlexiClip telescopic runner onto the front of the top rail of a shelf runner (1.).

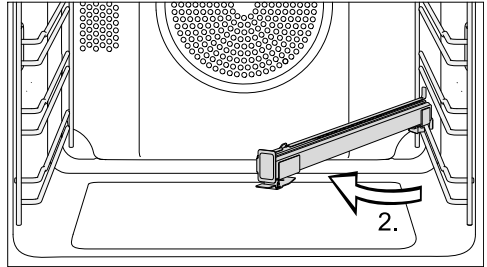

- Then hold the FlexiClip telescopic runner at an angle in towards the middle of the oven compartment (2.).

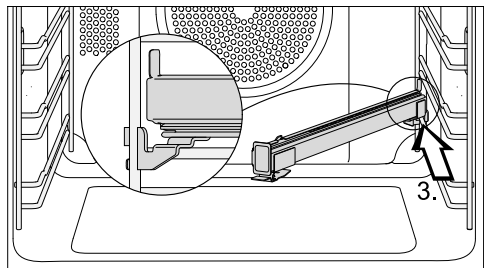

- Slide the FlexiClip telescopic runner at an angle along the top rail as far as it will go (3).

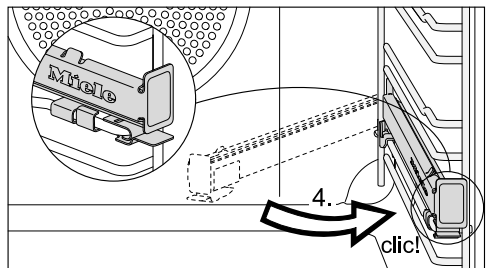

- Then swing the FlexiClip telescopic runner back to the side and secure it to the top rail with an audible click (4).

If the FlexiClip telescopic runners are difficult to pull out after fitting, you may need to pull firmly on them once to release them.

Features

Removing the FlexiClip telescopic runners

 Risk of injury caused by hot surfaces.

The oven gets hot during operation. You could burn yourself on the heating elements, the oven compartment, or accessories.

Allow the heating elements, oven compartment and the accessories to cool down before fitting or removing the FlexiClip telescopic runners.

- Push the FlexiClip telescopic runner in all the way.

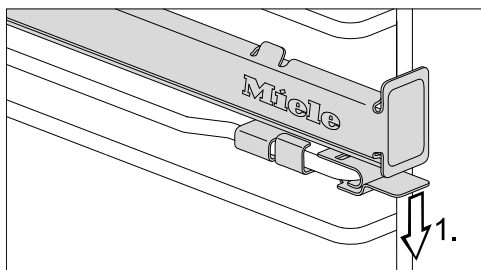

- Push down on the tab at the front of the FlexiClip telescopic runner (1.).

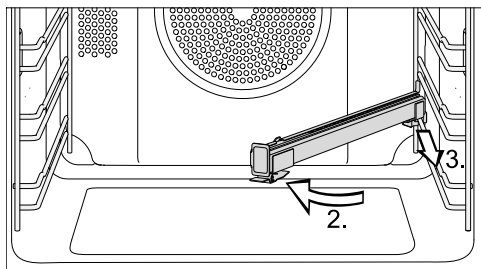

- Swing the FlexiClip telescopic runner towards the middle of the oven compartment (2.), then pull it forwards along the top rail (3.).
- Lift the FlexiClip telescopic runner off the rail and take it out of the oven.

Perforated gourmet baking tray HBBL 71

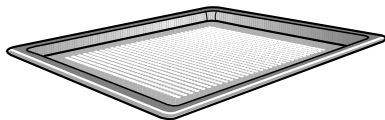

The perforated gourmet baking tray has been specially developed for the preparation of baked goods made from fresh yeast and quark doughs, as well as bread and bread rolls.

The tiny perforations assist in browning the underside of baked goods.

The gourmet baking tray can also be used for dehydrating or drying food.

The surface has been treated with PerfectClean enamel.

The **round perforated baking tray HBFP 27-1** can be used for the same things.

Baking stone HBS 70



The baking stone is ideal for items which need a well baked base such as pizza, quiche, bread, bread rolls and savoury snacks.

The baking stone is made from heat-retaining fireclay and is glazed. A paddle made of untreated wood is supplied with the baking stone for placing food on it and taking it off.

- Slide the rack in and place the baking stone on it.

Round baking trays



The **solid round baking tray HBF 27-1** is suitable for cooking pizzas, flat cakes made with yeast or whisked mixtures, sweet and savoury tarts, baked desserts, flat bread, and can also be used for frozen cakes and pizzas.

The **perforated round baking tray HBFP 27-1** has been specially developed for baked goods made from fresh yeast and quark dough and for baking bread and rolls. The tiny perforations assist in browning the underside of baked goods. The tray can also be used for dehydrating or drying food.

The surface of both baking trays has been treated with PerfectClean enamel.

- Insert the rack and place the round baking tray on the rack.

Grilling and roasting insert HGBB 71

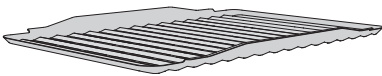

The grilling and roasting insert fits in the universal tray.

The tray will collect meat juices and stop them from burning so that they can be used for making gravy and sauces.

The enamelled surface has been treated with PerfectClean.

HUB Gourmet oven dishes HBD Gourmet oven dish lids

Unlike other oven dishes, the Miele Gourmet oven dishes can be placed in the oven directly on the shelf runners. They have non-tip safety notches like the rack to prevent them from being pulled out too far. The surface of the oven dishes has a non-stick coating.

Gourmet oven dishes are available in different depths. The width and the height are the same.

Suitable lids are available separately. Please quote the model number when ordering.

Depth: 22 cm

HUB 5000-M
HUB 5001-M*

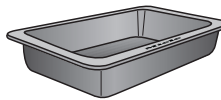

HBD 60-22

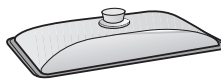

Depth: 35 cm

HUB 5001-XL*

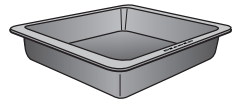

HBD 60-35

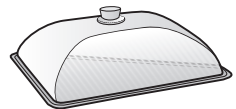

* Suitable for induction cooktops

Handle HEG

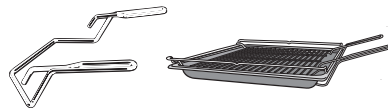

The handle makes it easier to take the universal tray, baking tray and rack out of the oven.

Features

Catalytic enamelled accessories

Catalytic enamelled surfaces are self-cleaning, which means that oil and fat are burnt off automatically when very high temperatures are reached inside the oven. See “Cleaning and care” for more information.

- Side panels

These are fitted behind the shelf runners and protect the oven walls against soiling.

- Back panel

This should be replaced if the catalytic enamel has become ineffective due to incorrect use or very heavy soiling.

When ordering, please quote the model number of your oven.

Accessories for cleaning and care

- Miele all purpose microfibre cloth
- Miele oven cleaner

Safety features

- **System lock**  for the oven (see “Clock/Timer - Changing settings”).

- Cooling fan

The cooling fan will come on automatically when a cooking programme is started. It ensures that the hot air in the oven compartment is mixed with cool ambient air and thus cooled before it is expelled via the gap between the door and the control panel.

The cooling fan will continue to run for a while after the oven has been switched off to prevent humidity building up in the oven compartment, on the control panel or on the oven housing unit.

The cooling fan will switch itself off automatically after a certain period of time.

- Safety switch-off

This safety switch-off is activated automatically if the oven has been operating for an unusually long period of time. The period of time will depend on the particular oven function being used.

- Ventilated door

The oven door is made of glass panes that have a heat-reflective coating on part of their surface. When the oven is operating, air is passed through the door to keep the outer pane cool.

The door can be removed and disassembled for cleaning purposes (see “Cleaning and care”).

PerfectClean treated surfaces

Surfaces treated with PerfectClean enamel are characterised by their exceptional non-stick properties and ease of cleaning.

Food can be easily removed from these surfaces. Soiling from baking and roasting can be easily removed from these surfaces.

Food can be sliced or cut up on PerfectClean surfaces.

However, do not use ceramic knives as these will scratch the PerfectClean surface.

Surfaces treated with PerfectClean enamel can be cleaned as you would clean glass.

Read the instructions in “Cleaning and care” so that the benefits of the non-stick properties and easy cleaning are retained.

PerfectClean treated surfaces:

- Oven compartment
- Universal tray
- Baking tray
- Grilling and roasting insert
- Gourmet perforated baking tray
- Round baking tray
- Round perforated baking tray





Cooktop controls

(features vary depending on model)

H2xxxE/H2xxxI cookers also have cooktop controls for operating the cooking zones on the linked cooktop.

The cooktop controls are retractable in the • position. The setting range is printed on them.

Cooking zones:

Symbol	Cooking zone
	Front left
	Rear left
	Rear right
	Front right

The cooktop can still be operated when the system lock  for the oven is switched on.

Please read the separate operating and installation instructions provided for the cooktop. It contains additional information on how to install and use your cooktop.

Before using for the first time

Before using for the first time

 The oven must be built into its housing unit before it can be used.

- Press and release the function and temperature selectors if they are retracted.

The time of day can only be changed when the function selector is at **0**.

- Set the time of day.

Setting the time of day for the first time

The time of day is displayed in 24-hour format.



After the oven is connected to the electricity supply, *12:00* will flash in the display.

The time of day is set in segments: first the hours, then the minutes.

- Confirm with *OK*.

12:00 will light up and  will flash.

- While the  symbol is flashing confirm with *OK*.

The hours will flash.

- Use *<* or *>* to set the hours.
- Confirm with *OK*.

The hours are saved and the minutes will flash.

- Use *<* or *>* to set the minutes.
- Confirm with *OK*.

The time of day is now saved.

The time of day can be displayed in 12-hour format by setting *P 2* in the settings menu to status *12* (see “Clock/Timer - Changing settings”).

Before using for the first time

Heating up the oven for the first time

When the oven is heated up for the first time it may give off a slight smell. This can be eliminated by heating the empty oven for at least an hour.

Ensure that the kitchen is well ventilated while the appliance is being heated up for the first time. Prevent odours from escaping into other rooms.

- Remove any protective foil and stickers except the data plate from the oven and accessories.
- Before heating the oven up, wipe the interior with a damp cloth to remove any dust or bits of packaging that may have accumulated during storage and unpacking.
- Fit the FlexiClip telescopic runners (if present) to the shelf runners and insert all trays and the rack.
- Select Fan Plus .

The recommended temperature of 160 °C will appear. The  symbol will flash.

The oven heating, lighting and cooling fan will switch on.

- Select the maximum temperature (250 °C).
- Heat up the empty oven for at least one hour.
- After heating up, turn the function selector to **0**.

Cleaning the oven compartment after heating it up for the first time

 Risk of injury caused by hot surfaces.









The oven gets hot during operation. You could burn yourself on the heating elements, the oven compartment, or accessories.

Allow the heating elements, oven compartment and the accessories to cool before manual cleaning.





- Take all accessories out of the oven and clean them by hand (see “Cleaning and care”).
- Clean the oven compartment with a clean sponge and a solution of hot water and washing-up liquid or a clean, damp microfibre cloth.
- Dry all surfaces with a soft cloth.

Leave the oven door open until the oven interior is completely dry.

Overview of functions

Oven functions	Recommended value	Range
Fan Plus 	160 °C	30–250 °C
Intensive Bake 	170 °C	50–250 °C
Eco Fan Heat 	190 °C	100–250 °C
Defrost 	25 °C	25–50 °C
Booster 	160 °C	100–250 °C
Conventional Heat 	180 °C	30–250 °C
Bottom Heat 	190 °C	100–250 °C
Full Grill 	240 °C	200–250 °C
Fan Grill 	200 °C	100–250 °C

Cooking programmes

- Remove any accessories from the oven that are not required for a cooking programme.
- In general, if a range of temperatures is given in a recipe or chart, it is best to select the lower temperature and to check the food after the shortest duration.
- Pre-heat the oven only if instructed to do so in the recipe or the cooking chart.
- Avoid opening the door during a cooking process.
- It is best to use dark bakeware and cooking containers with a matte finish made of non-reflective materials (enamelled steel, heat-resistant glass, non-stick coated cast aluminium). Shiny materials such as stainless steel or aluminium reflect the heat, preventing it from reaching the food efficiently. Do not cover the oven floor or the rack with heat-reflective aluminium foil.
- Monitor cooking durations to avoid wasting energy when cooking food. Set the cooking duration or use a food probe if you have one.
- The Fan Plus  function can be used for cooking many types of food. Because the fan distributes the heat in the oven compartment straight away, it allows you to use a lower temperature than you would with Conventional Heat . It also enables you to cook on several shelf levels at the same time.
- Eco Fan Heat  is an innovative function which is suitable for small amounts of food, e.g. frozen pizzas, bake-off rolls, biscuits and for meat dishes and roasts. The cooking process is energy-efficient thanks to optimal utilisation of heat. When cooking on a single level, up to 30 % less energy is used with comparatively good cooking results. Do not open the door during the cooking programme.
- Fan Grill  is the best function for grilled dishes. With Fan Grill you can use lower temperatures than with other grill functions which use the maximum temperature setting.
- Whenever possible you should cook several dishes at the same time. Place them next to each other in the oven or on different shelf levels.
- Dishes which you are unable to prepare at the same time should, if possible, be cooked one after the other in order to make use of existing heat in the oven.

Energy saving tips

Using residual heat

- The temperature in cooking programmes using temperatures above 140 °C which take longer than 30 minutes to cook can be turned down to the lowest possible temperature about 5 minutes before the end of cooking. The residual heat in the oven is sufficient for cooking the food. However, do not switch the oven off (see “Warning and safety instructions”).
- If you wish to run the programme for cleaning oil and grease off the catalytic enamelled parts of the oven, it is best to do so immediately after a cooking programme. The residual heat in the oven will help reduce the amount of energy required.

Energy saving mode

The oven will switch itself off automatically to save energy if a programme is not being run and no controls have been operated. The time of day will appear in the display or the display will remain dark (see “Clock/Timer - Changing settings”).

Basic operation

- Place the food in the oven.
- Select the required oven function with the function selector.

The recommended temperature will appear.

The oven lighting, heating, and the cooling fan will switch on.

- Change the temperature with the temperature selector if necessary.

The current temperature will appear and the heating-up phase will begin.



You will see the temperature rising in the display. A signal will sound when the selected temperature is reached for the first time.

- When the cooking programme is finished, turn the function selector to **0**.
- Take the food out of the oven.

Pre-heating the oven

The Booster function is used to quickly pre-heat the oven.

It is only necessary to pre-heat the oven in a few instances.

- Most dishes can be placed in a cold oven. They will then make use of the heat produced during the heating-up phase.
- Pre-heat the oven for the following preparations and oven functions:
 - Dark bread dough and beef sirloin joints and fillet with the Fan Plus  and Conventional Heat  functions

- Cakes and pastries with a short cooking duration (up to approx. 30 minutes) and delicate items (e.g. sponge) with the Conventional Heat  function

Rapid Heat-up

You can shorten the heating-up phase with the Booster  function.

Do not use the Booster  function to pre-heat the oven when baking pizzas or delicate mixtures (e.g. sponge cake, biscuits). This food will otherwise brown too quickly from the top.

- Select Booster .
- Select the temperature.
- Change to the required oven function after the set temperature has been reached.
- Place the food in the oven.

Clock/Timer

The clock/timer offers the following functions:

- Time of day display
- Minute minder
- Switching cooking processes on and off automatically
- Altering various settings *P*

The clock/timer is operated via the **display** and the **OK** and **< >** **sensors**.

The functions available are indicated by symbols.

Display

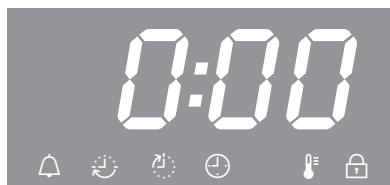

Symbols in the display

Depending on the position of the function selector \bigcirc and/or whether a sensor has been pressed, the following symbols appear:

Symbol/Function	\bigcirc
Minute minder	Any
Duration	Oven function
Finish time	
Temperature	
Time of day	0
<i>P</i> Setting	
5 Setting status	
System lock	

You can only set or change a function if the function selector is in the corresponding position.

Sensor controls

Sensor	Use
<	<ul style="list-style-type: none"> - Highlighting functions - Reducing times - Calling up settings <i>P</i> - Changing the status 5 of a setting <i>P</i>
>	<ul style="list-style-type: none"> - Highlighting functions - Increasing times - Changing the status 5 of a setting <i>P</i>
OK	<ul style="list-style-type: none"> - Calling up functions - Saving set times and adjusted settings - Calling up set times





Set hours, minutes and seconds with the < or > sensor in increments of 1. If you hold the sensor down the display will count faster.

How to set the time or a duration

Times are set in segments:

- for the time of day and cooking durations, first the hours, then the minutes.
- for a minute minder duration, first the minutes, then the seconds.

■ Confirm with *OK*.

Depending on the position of the function selector, the functions , ,  or  will appear.

■ Highlight the required function using the < or > sensor.

The corresponding symbol will flash for approx. 15 seconds.

■ While the symbol is flashing, confirm with *OK*.

The function is selected and the left numeric block will start to flash.

You can only set the time while the numeric block is flashing. If the time has elapsed and the numeric block is no longer flashing, you have to select the function again.

■ Set the required value using the < or > sensor.

■ Confirm with *OK*.



The right numeric block will flash.



■ Set the required value using the < or > sensor.

■ Confirm with *OK*.

Your time/duration setting is now saved.

Displaying times/durations

If you have set times, the symbols  and  or  indicate which time functions have been set.

If you are using the minute minder , cooking duration  and end of cooking time  functions simultaneously, the last time that you set will be displayed.

If you have set a cooking duration, the time of day cannot be displayed.

When the time/duration has elapsed

Once a set time has elapsed, the relevant symbol will flash and a signal will sound, if this option is selected (see “Clock/Timer - Changing settings”).

■ Confirm with *OK*.

The signal tone will stop and the symbols in the display will go out.

Clock/Timer

Using the minute minder

The minute minder can be used to time other activities in the kitchen, e.g. boiling eggs.

The minute minder can also be used at the same time as a cooking programme for which the duration and finish time have been set, e.g. as a reminder to stir a dish or add seasoning etc.

A maximum minute minder time of 99 minutes and 59 seconds can be set.

Setting the minute minder

Example: You want to boil some eggs and set a minute minder time of 6 minutes and 20 seconds.



- Press < repeatedly until  starts flashing.
- Confirm with OK.



00:00 appears in the display and the minutes will flash.

If you press < once, two lines will appear and, after pressing it again, the maximum possible minute value 99 will appear.



- Use < or > to set the minutes.
- Confirm with OK.

The minutes are saved and the seconds will flash.



- Use < or > to set the seconds.
- Confirm with OK.



The minute minder is saved and will count down in seconds.

The  symbol indicates that the minute minder has been set.

At the end of the minute minder time

-  flashes.
- The time will count upwards.
- A signal tone will sound for approx. 7 minutes, if this option is selected (see “Clock/Timer - Changing settings”).

- Confirm with *OK*.

The signal tone will stop and the symbols in the display will go out.

If no cooking duration has been set, the time of day will appear in the display.

Changing the time set for the minute minder

- Press < repeatedly until  starts flashing.

The set minute minder time will appear.

- Confirm with *OK*.

The minutes will flash.

- Use < or > to set the minutes.

- Confirm with *OK*.

The seconds will flash.

- Use < or > to set the seconds.

- Confirm with *OK*.

The changed minute minder time is saved and will count down in seconds.

Cancelling the minute minder

- Press < repeatedly until  starts flashing.

- Confirm with *OK*.

The minutes will flash.

- Reduce the minutes to *00* using the < sensor or increase them to *99* using the > sensor.

The next time the respective sensor is selected, two lines will appear in place of the minute number block:



- Confirm with *OK*.

Four lines will appear:





- Confirm with *OK*.

The minute minder is cancelled.

If no cooking duration has been set, the time of day will appear in the display.

Clock/Timer

Switching cooking programmes on and off automatically

Cooking programmes can be switched on or off automatically with all oven functions except for Full Grill  and Fan Grill .

To do this, set a duration or a duration and a finish time after selecting the oven function and temperature.

The maximum duration which can be set for a cooking programme is 11 hours and 59 minutes.

We recommend switching on and off automatically when roasting. When baking, the oven should not be set to start a long time off. Otherwise the cake mixture or dough will dry out, and the raising agents will lose their effectiveness.

Setting a cooking duration

Example: To bake a cake for 1 hour and 5 minutes:

- Place the food in the oven.
- Select the oven function and the temperature.

The oven heating, lighting and cooling fan will switch on.

- Press > repeatedly until  starts flashing.

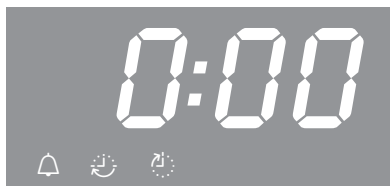

0:00 appears in the display.

- Confirm with OK.

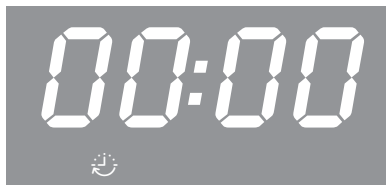

00:00 appears and the hours start flashing.

If you press < once, two lines will appear and, after pressing it again, the maximum possible hour value ## will appear.

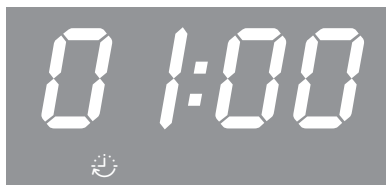

- Use < or > to set the hours.
- Confirm with OK.

The hours are saved and the minutes will flash.

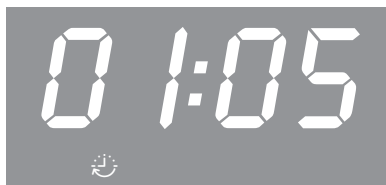

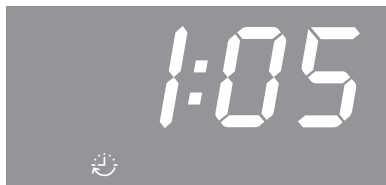

- Use < or > to set the minutes.
- Confirm with OK.



The cooking duration is saved and then counts down in minutes, with the last minute counting down in seconds.

The  symbol indicates that a cooking duration has been set.

At the end of the cooking duration:

-  appears in the display.
-  flashes.
- The oven heating switches off automatically.
- The cooling fan continues to run.
- A signal tone will sound for approx. 7 minutes, if this option is selected (see “Clock/Timer - Changing settings”).
- Confirm with *OK*.
- The signal tone will stop and the symbols in the display will go out.
- The time of day appears.
- The oven heating will switch back on.
- Turn the function selector to **0**.
- Take the food out of the oven.

Setting a cooking duration and finish time

A cooking duration and finish time can be set to switch a cooking programme on and off automatically.

Example: The time is now 11:15; you want a dish with a cooking duration of 90 minutes to be ready by 13:30.

- Place the food in the oven.
- Select the oven function and the temperature.

The oven heating, lighting and cooling fan will switch on.

Set the cooking duration first:

- Press **>** repeatedly until  starts flashing.
- Confirm with *OK*.

 appears in the display and the hours will flash.

- Use **<** or **>** to set the hours.
- Confirm with *OK*.

The hours are saved and the minutes will flash.

- Use **<** or **>** to set the minutes.
- Confirm with *OK*.

The cooking duration is now saved.

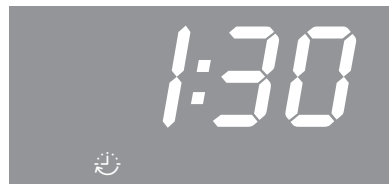

The  symbol indicates that a cooking duration has been set.

Clock/Timer

Then set the finish time:

- Press > repeatedly until  starts flashing.

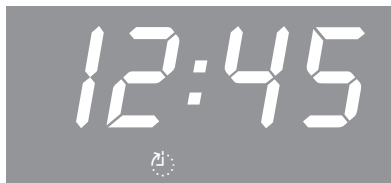

12:45 appears in the display (current time of day + cooking duration = 11:15 + 1:30).

- Confirm with OK.

The hours will flash.



- Use < or > to set the hours.
- Confirm with OK.

The hours are saved and the minutes will flash.



- Use < or > to set the minutes.
- Confirm with OK.

The finish time  is now saved.

The oven heating, lighting and cooling fan will switch off.

The selected finish time appears in the display.

As soon as the start time (13:30 - 1:30 = 12:00) is reached, the oven heating, lighting and cooling fan will switch on.

The set cooking duration  appears in the display and then counts down in minutes, with the last minute counting down in seconds.

Changing the cooking duration

- Press > repeatedly until  starts flashing.

The remaining cooking duration appears in the display.

- Confirm with OK.

The hours will flash.

- Use < or > to set the hours.
- Confirm with OK.

The minutes will flash.

- Use < or > to set the minutes.
- Confirm with OK.

The changed cooking duration is now saved.

Deleting a cooking duration

- Press < or > repeatedly until  starts flashing.
- Confirm with OK.

The hours will flash.

- Press < or > repeatedly until two lines appear:

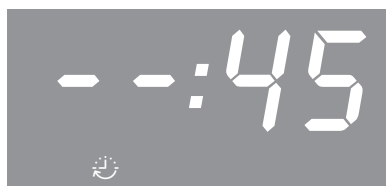

- Confirm with OK.

Four lines appear:

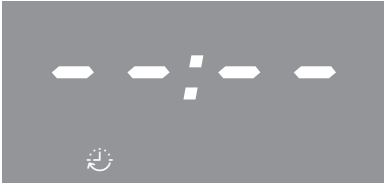

- Confirm with *OK*.

The cooking duration and any finish time set are deleted.

The time of day appears if no minute minder has been set.

The oven heating, lighting and cooling fan will switch on.

If you want to end the cooking programme:

- Turn the function selector to **0**.
- Take the food out of the oven.

Deleting a finish time

- Press **<** or **>** repeatedly until  starts flashing.
- Confirm with *OK*.

The hours will flash.

- Press **<** or **>** repeatedly until two lines appear.
- Confirm with *OK*.

Four lines appear:

- Confirm with *OK*.

The  symbol appears and the set cooking duration counts down in minutes, with the last minute counting down in seconds.

If you want to end the cooking programme:

- Turn the function selector to **0**.
- Take the food out of the oven.

If you turn the function selector to **0**, the settings for the cooking duration and the finish time will be deleted.

Changing the time of day

The time of day can only be changed when the function selector is at **0**.

- Turn the function selector to **0**.
- Press **>** repeatedly until  starts flashing.
- Confirm with *OK*.

The hours will flash.

- Use **<** or **>** to set the hours.
- Confirm with *OK*.

The hours are saved and the minutes will flash.

- Use **<** or **>** to set the minutes.
- Confirm with *OK*.

The time of day is now saved.

After a power cut, the time of day needs to be re-entered.

Clock/Timer

Changing settings

Your appliance is supplied with a number of default factory settings (see “Settings overview”).

A setting *P* is changed by altering its status *S*.

- Turn the function selector to **0**.
- Press and hold < until *P!* appears.



- If you want to change another setting, press < or > repeatedly until the relevant number appears.
- Confirm with **OK**.



The setting is selected and the current status *S* appears, e.g. *0*.

To change the status:

- Press < or > repeatedly until the required status appears in the display.
- Confirm with **OK**.

The selected status is saved and the setting *P* appears again.

To change further settings, proceed in the same way.

If you do not want to change any further settings:

- Wait approx. 15 seconds until the time of day appears.

Settings remain in the memory even after a power cut.

Settings overview

Setting	Status
<i>P 1</i> Buzzer volume	<p>5 0 The buzzer is switched off.</p> <p>5 1 to 5 30* The buzzer is switched on. You can adjust the volume. When you select a status, you will hear the corresponding buzzer.</p>
<i>P 2</i> Clock format	<p>24* The time of day is shown in the 24-hour format.</p> <p>12 The time of day is shown in the 12-hour format. If you change the clock after 1:00 pm from a 12-hour clock to a 24-hour clock you will need to update the hour accordingly.</p>
<i>P 3</i> System lock for the oven	<p>5 0* The system lock is switched off.</p> <p>5 1 The system lock is switched on and  appears in the display. The system lock prevents the oven from being used unintentionally, for example by children. The system lock remains active even after a power cut.</p>
<i>P 4</i> Keypad tone	<p>5 0 The keypad tone is switched off.</p> <p>5 1* The keypad tone is switched on.</p>
<i>P 5</i> Temperature display	<p>°C* The temperature is displayed in degrees Celsius.</p> <p>°F The temperature is displayed in degrees Fahrenheit.</p>

* Factory settings

Baking

Handling food carefully will help protect your health.

Cakes, pizzas and chips should be cooked until golden, not dark brown.

Tips on baking

- Set a cooking duration. When baking, the oven should not be set to start a long time off. Otherwise the cake mixture or dough will dry out, and the raising agents will lose their effectiveness.
- Generally, you can use the rack, baking tray, universal tray and any type of baking tray made of heat-resistant material.
- Avoid using bright, thin-walled tins as they give an uneven or poor browning result. In certain unfavourable conditions, the food will not cook properly.
- Place cakes in rectangular tins on the rack with the longer side across the width of the oven for optimum heat distribution and even results.
- Always place bakeware on the rack.
- Bake cakes with fruit toppings or deep cakes on the universal tray.

Using baking paper

Miele accessories, e.g. the universal tray, are treated with PerfectClean enamel (see “Features”). Surfaces treated with PerfectClean enamel generally do not need to be greased or covered with baking paper.

- Use baking paper when baking lye pastries (e.g. pretzels) because the sodium hydroxide can damage the PerfectClean treated surface.
- Use baking paper when baking sponge, meringue, macaroons or similar items. These are more likely to stick due to their high egg white content.
- Use baking paper when cooking frozen food on the rack.

Notes on the cooking charts

You can find the cooking charts at the end of this book.

Selecting the temperature

- As a general rule, select the lower temperature given in the chart. Baking at temperatures higher than those recommended may reduce the cooking duration, but will lead to uneven browning of the food, and unsatisfactory cooking results.

Selecting the cooking duration

Unless otherwise stated, the cooking durations given in the cooking charts are for an oven compartment which has not been pre-heated. With a pre-heated oven compartment, shorten durations by around 10 minutes.

- As a general rule, check whether the food is cooked after the shortest duration. Stick a wooden skewer into the food.

If it comes out clean without any batter/dough on it, the food is done.

Notes on the oven functions

You can find an overview of all the functions with their recommended values in “Overview of functions”.

Using Fan Plus

Because the fan distributes the heat around the oven compartment straight away, you can use a lower temperature than you would with the Conventional Heat  function.

Use this function if you are baking on multiple shelf levels at the same time.

- 1 shelf: Place the food on shelf level 2.
- 2 shelves: Place the food on shelf levels 1+3 or 2+4.
- 3 shelves: Place the food on shelf levels 1+3+5.

Useful tips

- If you are cooking on multiple shelf levels at the same time, slide the universal tray in on the lowest level.
- For moist biscuits and cakes, bake on a maximum of 2 shelf levels at once.

Using Intensive Bake

Use this function for baking cakes with moist toppings.

Do **not** use this function for baking thin biscuits.

- Place cakes on shelf level 1 or 2.

Using Conventional Heat

Dark metal, enamel, or aluminium bakeware with a matte finish, as well as heat-resistant glass, ceramic, and coated bakeware can be used.

Use this function for baking traditional recipes. If using an older recipe or cookbook, set the oven temperature 10 °C lower than that recommended. This will not change the cooking duration.

- Place the food on shelf level 1 or 2.

Using Eco Fan Heat

Use this function for cooking small amounts of food, e.g. frozen pizzas, bake-off rolls or biscuits, while saving energy.

- Place the food on shelf level 2.

Roasting

Tips for roasting

- You can use any crockery made from temperature-resistant materials, e.g. oven dishes, roasting pans with lid, ovenproof glass dishes, roasting bags, dishes made from earthenware or cast iron, the universal tray, rack and/or grilling and roasting insert (if present) on top of the universal tray.
- **Pre-heating** the oven compartment is only required when roasting beef sirloin joints and fillet. Pre-heating is generally not necessary.
- Use a **closed roasting dish** for roasting meat, such as an oven dish. The meat stays succulent. The oven compartment will also stay cleaner than when roasting on the rack. It ensures that sufficient stock remains for making gravy.
- If you are using a **roasting bag**, follow the instructions on the packaging.
- If you are using the **rack** or an **open roasting dish** for roasting, you can add a little fat or oil to very lean meat or place a few strips of streaky bacon on the top.
- **Season** the meat and place in the roasting dish. Dot with butter or margarine or brush with oil or cooking fat if necessary. For large lean cuts of meat (2–3 kg) and fatty poultry, add about 1/8 l of water to the dish.
- Do not add too much liquid during cooking as this will hinder the **browning** of the meat. Browning only occurs towards the end of the cooking duration. Remove the lid about halfway through the cooking duration if a more intensive browning result is desired.



- At the end of the programme, take the food out of the oven compartment, cover it and leave to **stand** for about 10 minutes. This helps retain juices when the meat is carved.
- For a crisp finish, baste **poultry** 10 minutes before the end of the cooking duration with slightly salted water.

Notes on the cooking charts

You can find the cooking charts at the end of this book.

- Take note of the temperature range, the shelf levels and the timings. These also take the type of cooking container, the size of the meat and cooking practices into account.

Selecting the temperature

- As a general rule, select the lower temperature given in the chart. If higher temperatures are used than those specified, the meat will brown on the outside, but will not be properly cooked through.
- When cooking with Fan Plus , select a temperature 20 °C lower than when using Conventional Heat .
- For cuts which weigh more than 3 kg, select a temperature approx. 10 °C lower than that given in the cooking chart. The roasting process will take longer, but the meat will cook evenly through and the skin or crackling will not be too thick.
- When roasting on the rack, set a temperature approx. 10 °C lower than for roasting in a covered oven dish.

Selecting the cooking duration

Unless otherwise stated, the durations given in the cooking chart are for an oven compartment which has not been pre-heated.

- Determine the cooking duration by multiplying the thickness of the roast [cm] with the time per cm [min./cm] stated below, depending on the type of meat:
 - Beef/Venison: 15–18 min./cm
 - Pork/Veal/Lamb: 12–15 min./cm
 - Sirloin joints/Fillets: 8–10 min./cm
- As a general rule, check whether the food is cooked after the shortest duration.

Notes on the oven functions



You can find an overview of all the functions with their recommended values in “Overview of functions”.

Use the Bottom Heat  function towards the end of the cooking duration to brown the base of the food.

Do not use the Intensive Bake  function for roasting as the juices will become too dark.

Using Fan Plus

This function is suitable for roasting meat, fish and poultry that needs to be well browned as well as sirloin joints and fillet.

The Fan Plus  function allows you to use a lower temperature than you would with the Conventional Heat  function, because the heat is immediately distributed throughout the oven compartment.

- Place the food on shelf level 2.

Using Conventional Heat

Use this function for baking traditional recipes. If using an older recipe or cookbook, set the oven temperature 10 °C lower than that recommended. This will not change the cooking duration.

- Place the food on shelf level 2.

Using Eco Fan Heat

Use this function for cooking smaller roasts or meat dishes in an energy-saving way.

- Place the food on shelf level 2.

Grilling

 Risk of injury caused by hot surfaces.

If you grill with the door open, hot air will escape from the oven instead of being cooled by the cooling fan. The control elements will get hot.

Grill with the oven door closed.

Tips for grilling

- Pre-heating is necessary when grilling. Pre-heat the top heat/grill element for approx. 5 minutes with the door closed.
- Trim the meat if necessary. Season meat 10-15 minutes before cooking.
- Add a little oil to lean meat if necessary. Do not use other types of fat as they can easily burn and cause smoke.
- Clean fish in the normal way. To enhance the flavour, season with a little salt. Fish can also be drizzled with lemon juice.
- Use the universal tray with the rack or the grilling and roasting insert (if present) placed on top. The tray under the insert will collect the meat juices and stop them from burning so that they can be used for making gravy and sauces. To grill, brush the rack or the grilling and roasting insert with oil and then place the food on the rack.

Do not use the baking tray.

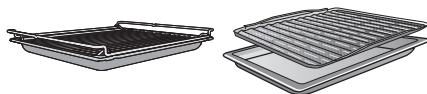

Notes on the cooking charts

You can find the cooking charts at the end of this book.

- Take note of the temperature range, the shelf levels and the timings. These take the size of the meat and cooking practices into account.
- Check the food after the shortest duration quoted.

Selecting the temperature

- As a general rule, select the lower temperature given in the chart. If higher temperatures than those specified are used, the meat will brown on the outside, but will not be properly cooked through.

Choosing a shelf level

- Select the shelf level depending on the thickness of the food to be cooked.
- Place flat food on shelf level 3 or 4.
- Place thicker food on shelf level 1 or 2.

Selecting the cooking duration

- Grill thinner cuts of meat/slices of fish for approx. 6–8 minutes per side. It is best to grill food of a similar thickness at the same time so that the cooking durations do not vary too much.
- As a general rule, check whether the food is cooked after the shortest duration.
- To **test the food**, press down on the meat with a spoon. This lets you determine how well the meat has been cooked.
 - **Rare**
If the meat gives easily to the pressure of the spoon, it will still be red on the inside.
 - **Medium**
If there is some resistance, the inside will be pink.
 - **Well-done**
If there is great resistance, it is cooked through.

Useful tip: If the surface of a thicker cut of meat is browned but the centre is still raw, move the food to a lower level or reduce the temperature and continue grilling. This will stop the surface from becoming excessively charred.

Notes on the oven functions

You can find an overview of all the functions with their recommended values in “Overview of functions”.

Using Full Grill

Use this function to grill flat thin cuts in large quantities and for browning large baked dishes.

The entire top heat/grill element will get hot and glow red.



Using Fan Grill

This function is suitable for grilling thicker food, such as chicken.



A temperature setting of 220 °C is generally recommended for thinner types of food, while 180–200 °C is recommended for thicker cuts.

Grilling

Fan Grill

- Use the Fan Grill  function for meat, fish, poultry and vegetables.
- Always pre-heat for at least 5 minutes before Fan Grilling.
- It is not necessary to turn food when Fan Grilling . Only one side of the food, however, will become brown.
- The door must be closed when using Fan Grill .
- When using red meat, pat the meat dry before Fan Grilling as this encourages a richer colour.

All temperatures are approximations and must be varied according to the thickness and preparation of the meat. The chart below is a suggested guide only. Personal taste and size of serves will vary times and temperatures. We recommend you monitor cooking results for best outcomes.

Food to be grilled	 [°C]	 5 1	 [min.]
Lean thin sausages	180	4	8–10
Thick sausages	180	4	15–20
Lean beef fillet steak	220	5	6–12
Chicken breast fillet	200	4	14–18
Whole butterflied chicken	200	3	30–35
Thin white fish fillets	220	5	6–10
Thick fish fillets, cutlets or steaks	200	4	10–15
Oily fish	200	4	8–12
Lamb loin chops	190	4	12–16
Lamb back straps	220	5	8–10
Vegetables, capsicum, zucchini, sweet potato, eggplant	200	5	12–15
Potato wedges or small roast potatoes	220	3	20–25
Kebabs and satays (red meat)	200	5	12–15
Chicken satays	200	4	12–15

 Temperature /  Shelf level /  Duration

Fan Grill  can be used for small roasts but is only recommended for lean, tender cuts of meat, e.g. lamb racks, rump roasts, and beef fillet. Fan Grill the roast at 200 °C on shelf level 3 for approximately 25 minutes, depending on thickness.

Grill

- Use Grill  for thick toasts, muffins, cheese on toast, focaccia, bruschetta and bacon.
- Pre-heat the grill for at least 5 minutes at 200–220 °C.
- Select the appropriate shelf level for the thickness of the food.
- The door must be closed when using the Grill function.

This is a suggested guide only. Personal taste and size of serves will vary times and temperatures.

Other applications

This section provides information on the following applications:

- Defrost
- Low temperature cooking
- Bottling
- Drying
- Frozen food/Ready meals
- Heating crockery

Defrost

Gentle defrosting of frozen goods means that the vitamins and minerals are generally retained.

- Select Defrost .
- Alter the recommended temperature if necessary.

Air is circulated throughout the oven compartment to gently defrost the frozen food.

 Risk of infection from bacteria. Bacteria such as salmonella can cause life-threatening food poisoning.

It is particularly important to observe food hygiene rules when defrosting fish and meat, and in particular when defrosting poultry.

Do not use the liquid produced during defrosting.

Process the food as required as soon as it has been defrosted.

Useful tips

- Remove the packaging and place the frozen goods on the universal tray or in a suitable bowl or dish.
- Use the universal tray with the rack placed on top of it for defrosting poultry. This way the frozen food will not be lying in the defrosting liquid.
- Meat and poultry need to be fully defrosted before cooking. Fish, on the other hand, can be partially defrosted before cooking. Defrost so that the surface is sufficiently soft to take herbs and seasoning.

Low temperature cooking

Low temperature cooking is ideal for cooking delicate cuts of beef, pork, veal or lamb when a tender result is desired.

First briefly sear the meat all over at a high temperature on the cooktop in order to seal it.

Then place the meat in the pre-heated oven where the low temperature and long cooking duration will cook it to perfection and ensure it is very tender.

The meat will relax. The juices inside will start to circulate evenly throughout the meat to reach the outer layers.

This gives very tender and succulent results.

- Use lean meat which has been correctly hung and trimmed. Bones should be removed before cooking.
- For searing, use a suitable cooking oil or fat that can withstand high temperatures (e.g. clarified butter, vegetable oil).
- Do not cover meat during the cooking process.

The cooking duration takes approx. 2–4 hours depending on the weight and size of the meat and how well you want it cooked.

- As soon as the cooking programme has finished, you can carve the meat straight from the oven. It does not need to rest.
- The meat can be left in the oven compartment to keep warm until you serve it. This will not affect results in any way.

- Serve on pre-heated plates with very hot sauce or gravy to prevent it cooling down too quickly. The meat is at the ideal temperature for eating straight away.

Using Conventional Heat

Refer to the information in the cooking charts at the end of this booklet.

Use the universal tray with the rack placed on top of it.

- Place the rack together with the universal tray on shelf level 2.
- Select the Conventional Heat  function and a temperature of 120 °C.
- Pre-heat the oven together with the universal tray and rack for approx. 15 minutes.
- While the oven is pre-heating, sear the meat on all sides on the cooktop.

 Risk of burning due to hot surfaces!

The oven gets hot during operation. You could burn yourself on the heating elements, the oven compartment, food or accessories. Wear oven gloves when placing food in the oven or removing it, and when adjusting oven shelves etc. in a hot oven.

- Place the seared meat on the oven rack.
- Reduce the temperature to 100 °C (see “Cooking charts”).
- Continue cooking until the end of the programme.

Other applications

Bottling

 Risk of infection from bacteria. The spores of the botulinum bacterium are not sufficiently killed by bottling pulses and meat only once. Toxins may form which can lead to serious poisoning. These spores are only destroyed by reheating the food within 2 days after preserving. After they have cooled down, **always** reheat pulses and meat a second time within 2 days.

 Risk of injury from increased pressure in sealed tins. Preserving and heating food in sealed tins will result in an increase in pressure, which can cause them to explode. Do not use tins for preserving or heating food.

Preparing fruit and vegetables

The instructions are for 6 jars with a capacity of 1 litre each.

Only use special jars for preserving (preserving jars or jars with a screw cap). Only use undamaged jars and rubber rings.

- Rinse the jars with hot water before bottling and fill them up to a maximum of 2 cm below the rim.
- Place the universal tray on shelf level 2 and place the closed jars on the tray.
- Select the Fan Plus  function and a temperature of 160–170 °C.
- Wait until bubbles evenly rise in the jars.



Reduce the temperature in time to prevent the contents from boiling over.

Bottling fruit and gherkins

- Set the specified continued warming temperature as soon as bubbles are visible in the jars, then leave the jars in the warm oven for the time specified.

Bottling vegetables

- As soon as bubbles are visible in the jars, set the specified bottling temperature and cook the vegetables for the time specified.
- After bottling, set the specified continued warming temperature, then leave the jars in the warm oven for the time specified.

		
Fruit	-/-	30 °C 25–35 min.
Gherkins	-/-	30 °C 25–30 min.
Beetroot	120 °C 30–40 min.	30 °C 25–30 min.
Beans (green or yellow)	120 °C 90– 120 min.	30 °C 25–30 min.

 Bottling temperature and time once bubbles are visible in the jars

 Continued warming temperature and time

Removing the jars after bottling

 Risk of injury caused by hot surfaces.

The jars are very hot after bottling. Wear oven gloves when removing the jars from the oven.

- Take the jars out of the oven.
- Cover the jars with a towel and leave for approx. 24 hours in a draught-free area.
- After they have cooled down, **always** reheat pulses and meat a second time within 2 days.
- Remove the fasteners from the jars and make sure all jars are closed properly when storing them.

Either boil open jars again or store them in a cool place and consume the preserved fruit or vegetables immediately.

- Check the jars during storage. If jars have opened during storage or if the screw cap is bulging and does not make a popping noise when opened, destroy the contents.

Other applications

Drying

Drying is a traditional method of preserving fruit, certain vegetables and herbs.





It is important that fruit and vegetables are ripe and not bruised before they are dried.

- Prepare the food for drying by cutting it up, and peeling and coring it if necessary.
- Distribute the food for drying evenly in a single layer according to size over the rack or the universal tray.

Useful tip: You can also use the gourmet perforated baking tray, if you have one.

- Dry on a maximum of 2 levels at the same time.
Place the food for drying on shelf levels 1+3.
If using the rack and universal tray, place the universal tray below the rack.
- Select Fan Plus .
- Change the default temperature and set the drying time.
- Turn the food for drying on the universal tray at regular intervals.

The drying times are longer for whole or halved food.

Food		🌡️ [°C]	🕒 [h]
Fruit		60–70	2–8
Vegetables		55–65	4–12
Mushrooms		45–50	5–10
Herbs*		30–35	4–8

 Function, 🌡️ Temperature, 🕒 Drying time,  Fan Plus,  Conventional Heat

* Dry herbs only on the universal tray on level 2 and use the Conventional Heat  function, as the fan is switched on in the Fan Plus function.

- Reduce the temperature if condensation begins to form in the oven.

Removing the dried food

 Risk of injury caused by hot surfaces.

The oven gets hot during operation. You could burn yourself on the heating elements, the oven compartment, or accessories. Use oven gloves when removing dried food from the oven.

- Allow the dried fruit or vegetables to cool down after drying.

Dried fruit needs to be completely dry, but also soft and elastic. Juice should not escape when cut.

- Store dried food in sealed glass jars or tins.

Frozen food/Ready meals

Tips for cakes, pizza and baguettes

- Bake cakes, pizza and baguettes on baking paper on the rack.
Do not use the baking tray or the universal tray for frozen foods with a large surface area. The tray could become warped and difficult, or even impossible, to remove from the oven compartment when hot. Additional use will make the warping worse.
- Use the lowest temperature recommended on the packaging.

Tips for oven chips, croquettes and similar items

- These frozen items can be cooked on the baking tray or universal tray.
Place baking paper on the tray so that they cook gently.
- Use the lowest temperature recommended on the packaging.
- Turn food several times during cooking.

Preparing frozen food/ready meals

Handling food carefully will help protect your health.
Cakes, pizzas and chips should be cooked until golden, not dark brown.



- Select the function and temperature recommended on the manufacturer's packaging.
- Pre-heat the oven.
- Place the food in the pre-heated oven on the shelf level recommended on the packaging.

- Check the food at the end of the shortest cooking duration recommended on the packaging.

Heat crockery

Use the Fan Plus  function for pre-heating crockery.

Only pre-heat heat-resistant dishes.

- Place the rack on shelf level 1 and place the crockery to be pre-heated on it. Depending on the size of the dishes, you can also place them on the oven floor and take out the shelf runners to make more room.
 - Select Fan Plus .
 - Set the temperature to 50–80 °C.
-  **Danger of burning!**
Wear oven gloves when removing dishes from the oven. Droplets of water may have accumulated underneath the crockery.
- Remove the heated crockery from the oven.

Cleaning and care

 Risk of injury caused by hot surfaces.

The oven gets hot during operation. You could burn yourself on the heating elements, the oven compartment, or accessories.

Allow the heating elements, oven compartment and the accessories to cool before manual cleaning.

 Risk of injury due to electric shock.

The steam from a steam cleaning appliance could reach electrical components and cause a short circuit.

Never use a steam cleaner for cleaning the oven.

The use of unsuitable cleaning agents can cause the surfaces to discolour or alter. The oven front is particularly susceptible to damage from oven cleaners or descaling agents.

All surfaces of this appliance are susceptible to scratching. Scratches on glass surfaces could cause a breakage in certain circumstances. Remove all cleaning agent residues immediately.

Unsuitable cleaning agents

To avoid damaging the surfaces of your appliance, do not use:

- cleaning agents containing soda, alkalines, ammonia, acids or chlorides
- cleaning agents containing descaling agents on the front
- abrasive cleaning agents, e.g. powder cleaners and cream cleaners
- solvent-based cleaning agents
- stainless steel cleaning agents
- dishwasher cleaners
- glass cleaning agents
- cleaning agents for ceramic cooktops
- hard, abrasive brushes or sponges, e.g. pot scourers, brushes or sponges which have been previously used with abrasive cleaning agents
- dirt erasers
- sharp metal scrapers
- steel wool or metal scourers
- spot cleaning with mechanical cleaning agents
- oven cleaners or oven sprays
- stainless-steel spiral pads

If soiling is left on for any length of time, it may become impossible to remove. Continued use without regular cleaning will make the oven much harder to clean. Failure to maintain the oven in a clean condition could lead to deterioration of the surfaces that could adversely affect the life of the appliance and result in a hazardous situation. Remove any soiling immediately.

The accessories are not dishwasher-safe.

Useful tip: Soiling caused by spilled fruit juices and cake mixtures is best removed while the oven is still warm. Exercise caution and make sure the oven is not too hot.

To make it easier to clean the oven:

- Remove the door.
- You can remove the shelf runners together with the FlexiClip telescopic runners (if present).
- Remove the catalytic enamelled back panel.
- Lower the top heat/grill element.

Removing normal soiling

Removing normal soiling

- It is best to remove normal soiling immediately using a clean sponge and a solution of hot water and washing-up liquid, or a clean, damp microfibre cloth.
- Remove any residual cleaning agent thoroughly with clean water. This is particularly important for any parts with a PerfectClean finish, as cleaning agent residues will impair the non-stick properties.
- After cleaning, wipe the surfaces dry using a soft cloth.

Cleaning the seal

There is a seal around the oven interior to seal it off from the inside of the door.

Grease deposits on the seal can cause it to become brittle and cracked.

- It is advisable to wipe the seal clean after each use.

Cleaning and care

Removing stubborn soiling (excluding the FlexiClip telescopic runners)

Spilled fruit and roasting juices may cause lasting discolouration or matte patches on surfaces. This discolouration will not affect the functional characteristics of the surface finish.

Do not attempt to remove these marks. Clean them following the instructions given here.

- Baked-on deposits can be removed with a glass scraper or with a stainless steel spiral pad, hot water and washing-up liquid.

Exposure to scouring agents, abrasive brushes or sponges and oven sprays can cause catalytic enamel to lose its self-cleaning properties.

Remove the catalytic enamelled panels before using an oven cleaner.

Using oven cleaners

- Very stubborn soiling on PerfectClean surfaces can be cleaned using Miele Oven Cleaner. This cleaner must only be applied to cold surfaces.

If the oven spray gets into gaps and openings, a strong odour is generated during subsequent cooking programmes.

Do not spray the oven cleaner onto the roof of the oven compartment.

Do not spray the oven cleaner into the gaps and openings of the oven compartment walls and rear wall.

- Follow the instructions on the packaging.

Oven cleaners from other manufacturers must only be used in a cold oven and must not be left on for longer than 10 minutes.

- If necessary, the scouring pad on the back of a non-scratching washing-up sponge can be used to remove the soiling after the soaking time.
- Remove any residual cleaning agent thoroughly with clean water.
- Dry all surfaces with a soft cloth.

Stubborn soiling on the FlexiClip telescopic runners

Do not clean FlexiClip telescopic runners in a dishwasher. The special lubricant used in the telescopic runners will wash out during dishwashing.

This will affect their smooth functioning.

For stubborn surface soiling or if the bearings become sticky, proceed as follows:

- Soak the FlexiClip runners briefly (approx. 10 minutes) in a solution of hot water and dishwashing liquid. If necessary, the scouring pad on the back of a non-scratching dishwashing sponge can be used to remove the soiling. You can clean the bearings with a soft brush.

The runners may appear discoloured or a lighter colour in places after they have been cleaned. This will not affect the functioning of the runners in any way.

Cleaning the catalytic enamelled back panel

Catalytic enamel is self-cleaning, which means that soiling from oil and fat is burnt off automatically when very high temperatures are reached inside the oven.

The higher the temperature, the more effective the process.

Exposure to scouring agents, abrasive brushes or sponges and oven sprays can cause catalytic enamel to lose its self-cleaning properties.

Remove the catalytic enamelled panels before using an oven cleaner.

Removing soiling caused by spices, sugar and similar deposits

- Remove the back panel (see “Cleaning and care – Removing the back panel”).
- Clean the back panel by hand with a solution of hot water and washing-up liquid applied with a soft brush.
- Rinse the back panel thoroughly.
- Let the back panel dry before placing it back in the oven.

Removing oil and grease soiling

- Remove all accessories from the oven, including the shelf runners.
- Wipe large deposits of soiling from the inside of the door and the PerfectClean enamelled surfaces before starting the catalytic cleaning process to avoid them baking on.
- Select the Fan Plus  function and 250 °C.
- Then heat the empty oven for at least 1 hour.

The length of time required will depend on the degree of soiling.

If the catalytic enamel is very heavily soiled with oil and grease, a film can form on the surfaces of the oven interior during the cleaning process.

 Risk of injury caused by hot surfaces.

The oven gets hot during operation. You could burn yourself on the heating elements and the oven interior.

Allow the heating element and oven compartment to cool before manual cleaning.

- Clean the inside of the door and the oven compartment with a solution of hot water and washing-up liquid, applied with a clean sponge, or a clean, damp microfibre cloth.

Any remaining soiling will gradually disappear with each subsequent use of the oven at high temperatures.

Cleaning and care

Removing the door

The door weighs approx. 9 kg.



The oven door is connected to the hinges by retainers. Before removing the door from the retainers, the locking clamps on both hinges have to be released.

- Open the door fully.

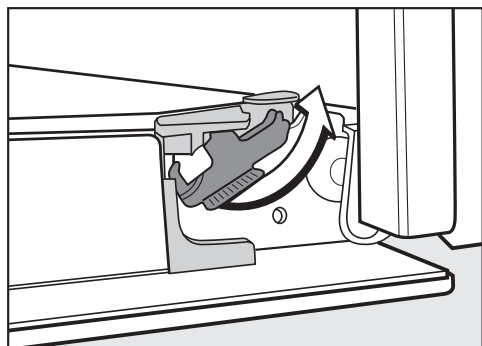

- Release the locking clamps by turning them as far as they will go.

The oven can be damaged if you remove the door incorrectly.

Do not pull the door horizontally off its retainers, as they will spring back against the oven.

Do not pull the door off the retainers by the handle, as the handle could break off.

- Raise the door up till it rests partially open.



- Hold the door on either side and pull it diagonally upwards from the hinge guides. Make sure that the door is straight.

Dismantling the door

The oven door is an open system with 3 glass panes which have a heat-reflective coating on some of their surfaces.

When the oven is operating, air is directed through the door to keep the outer pane cool.

If soiling has worked its way in between the glass panes, the door can be dismantled in order to clean in between the panes.

Scratches on the door glass can cause the glass to break.

Do not use abrasive cleaners, hard sponges, brushes or sharp metal tools to clean the door glass.

When cleaning the door glass, you must also follow the instructions that apply to the oven front.

Oven cleaners will damage the surface of the aluminium profiles.

Only clean these parts with warm water and washing-up liquid applied with a clean sponge, or with a clean, damp microfibre cloth.

The door glass panes can break if dropped.

Keep the disassembled door glass in a safe place.

 Risk of injury caused by the door slamming shut.

The door may slam shut if you attempt to disassemble it when it is fitted to the oven.

Always remove the door before disassembling it.

- Place the door with the outer glass pane on a soft surface (e.g. a tea towel) to prevent it getting scratched. The door handle should line up with the edge of the table so that the glass lies flat and does not get broken during cleaning.

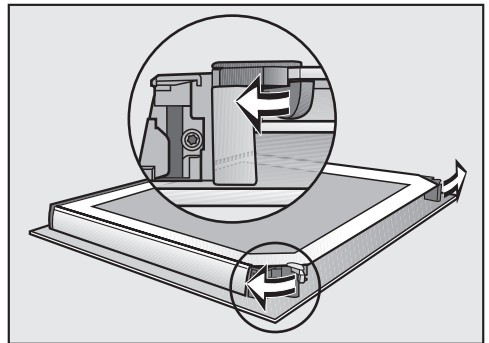

- Flip the two glass pane retainers outwards to open them.

Cleaning and care

To remove the inner pane:

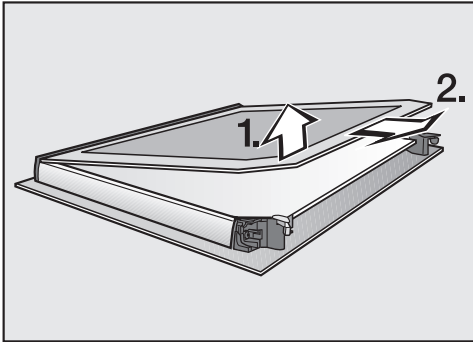

- **Gently** lift the inner pane up and out of the plastic strip.

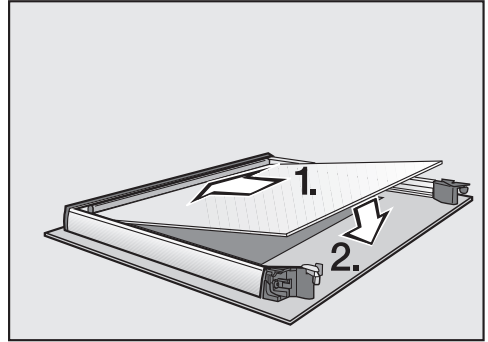

- Refit the middle pane in such a way that the material number is legible (not reversed).

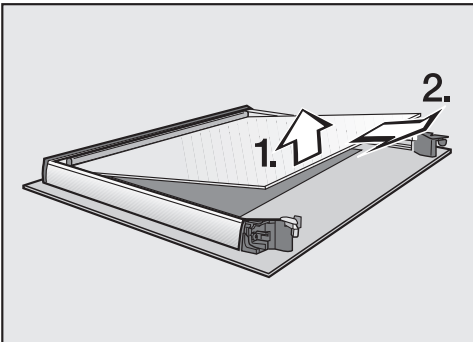

- Lift the middle pane up **gently** and pull it out.
- Clean the door panes and other individual parts with a clean sponge and a solution of hot water and washing-up liquid or a clean, damp microfibre cloth.
- Dry all parts with a soft cloth.

Then reassemble the door carefully.

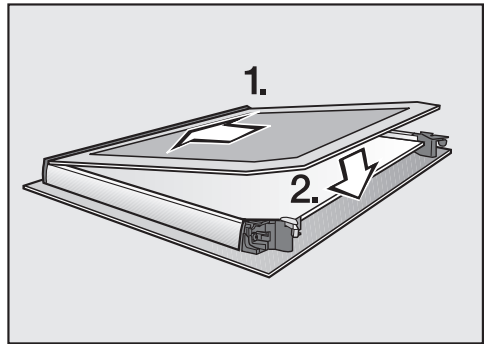

- Push the inner pane with the matt printed side facing downwards into the plastic strip and place it between the retainers.

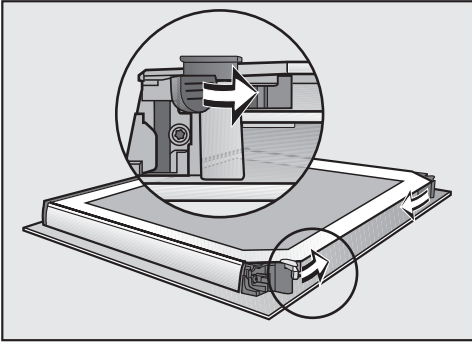

- Flip both the glass pane retainers inwards to close them.

The door is now reassembled.

Fitting the door

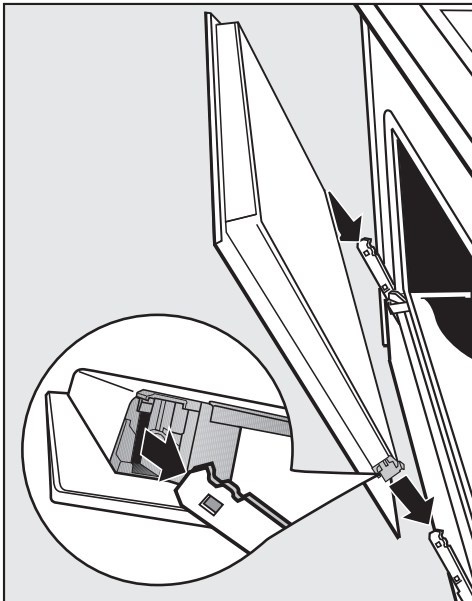

- Hold the door securely on both sides and carefully fit it back onto the hinge retainers. Make sure that the door goes back on straight.
- Open the door fully.

If the locking clamps are not locked, the door could work loose resulting in damage.

Ensure that the locking clamps are locked after refitting the door.

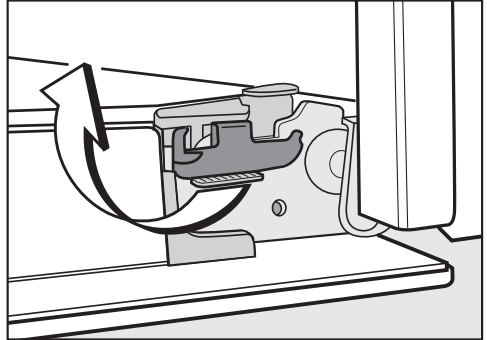

- To relock the locking clamps, flip them back up into a horizontal position as far as they will go.

Cleaning and care

Removing the shelf runners with FlexiClip telescopic runners

You can remove the shelf runners together with the FlexiClip telescopic runners (if present).

If you wish to remove the FlexiClip telescopic runners separately beforehand, please follow the instructions in “Features – Fitting and removing the FlexiClip telescopic runners”.

 Risk of injury caused by hot surfaces.

The oven gets hot during operation. You could burn yourself on the heating elements, the oven compartment, or accessories. Allow the heating elements, oven compartment and the accessories to cool before removing the shelf runners.

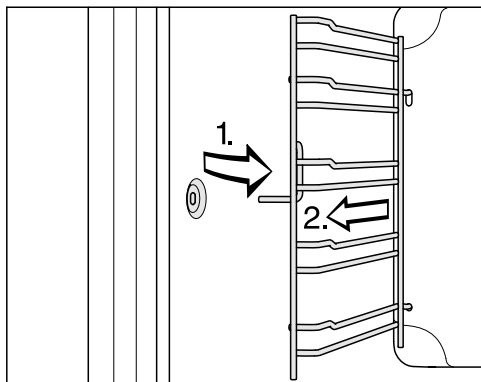

- Pull the shelf runners out of the holder (1) at the front of the oven and then pull them out of the oven (2).

Refit in the reverse order.

- Ensure that all parts are correctly fitted.

Removing the back panel

The back panel can be removed for cleaning purposes.

 Risk of injury caused by hot surfaces.

The oven gets hot during operation. You could burn yourself on the heating elements, the oven compartment, or accessories. Allow the heating element, oven compartment and the accessories to cool before removing the back panel.

 Risk of injury caused by the rotating fan impeller.

You could injure yourself on the impeller of the hot air fan. Never put the oven into operation without the back panel in place.

- Disconnect the appliance from the electricity supply. Switch off at the wall and withdraw the plug from the socket, or switch off at the mains circuit breaker.
- Remove the shelf runners.
- Undo the four screws in the corners of the back panel and take it out.
- Clean the back panel (see “Cleaning and care - Cleaning the catalytic enamelled back panel”).

Refit in the reverse order.

- Refit the back panel carefully.

Make sure the openings are located as illustrated in “Oven overview”.

- Refit the shelf runners.

- Reconnect the oven to the electricity supply.

Lowering the top heat/grill element

If the oven compartment roof is badly soiled, the top heat/grill element can be lowered to make cleaning easier. Clean the oven compartment roof regularly with a damp cloth or a dishwashing sponge.

 Risk of injury caused by hot surfaces.

The oven gets hot during operation. You could burn yourself on the heating elements, the oven compartment, or accessories. Allow the heating elements, oven compartment and the accessories to cool before manual cleaning.

The enamel on the oven floor can be damaged by fastening nuts being dropped on it. Place a cloth or similar item over the oven compartment floor to protect it.

- Remove the shelf runners.

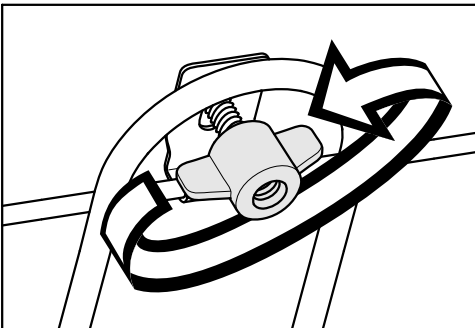

- Unscrew the wing nut.

Use caution not to damage the top heat/grill element.

Do not use force to lower the top heat/grill element as this can cause it to break.

- Carefully lower the top heat/grill element.



You can now access the ceiling of the oven compartment.

- Clean the ceiling of the oven compartment with a clean sponge and a solution of hot water and washing-up liquid or a clean, damp microfibre cloth.
- After cleaning, raise the top heat/grill element gently back up again.
- Replace the wing nut and tighten it securely.
- Refit the shelf runners.

Problem solving guide

With the help of the following guide, minor faults in the performance of the appliance, some of which may result from incorrect operation, can be remedied without contacting Miele. This will save you time and money because you won't need a service call.



Please note that a call-out charge will be applied to unnecessary service visits where the problem could have been rectified as described in these operating instructions.

Problem	Possible cause and remedy
The display is dark.	There is no power to the oven. ■ Check whether the mains circuit breaker has tripped. If it has, contact a qualified electrician or Miele.
The oven does not heat up.	The system lock  has been switched on. ■ Switch off the system lock (see "Clock/Timer - Changing settings"). There is no power to the oven. ■ Check if the circuit breaker has tripped. If it has, contact a qualified electrician or Miele.
12:00 is flashing in the display.	There has been a power cut. ■ Reset the time of day (see "Using for the first time"). Cooking times will also need to be reset.
0:00 appears unexpectedly in the display and  is flashing at the same time. The buzzer might also be sounding.	The oven has been operating for an unusually long time and this has activated the safety switch-off function. ■ Turn the function selector to 0 . The oven is now ready to use again immediately.
F XX appears in the display.	A fault has occurred that you cannot resolve. ■ Call Miele.
The signal tone does not sound.	Signal tones are switched off. ■ Switch on the signal tones (see "Clock/Timer - Changing settings").

Problem solving guide

Problem	Possible cause and remedy
<p>A noise can be heard after a cooking process.</p>	<p>The cooling fan will continue to run for a while after the oven has been switched off to prevent any humidity building up in the oven, on the control panel or in the oven housing unit.</p> <p>The cooling fan will switch itself off automatically after a certain period of time.</p>
<p>The oven has switched itself off.</p>	<p>The oven will switch itself off automatically to save energy if no other action is taken within a certain time frame after switching it on or after the end of a cooking programme.</p> <ul style="list-style-type: none"> ■ Switch the oven back on.
<p>Cakes and biscuits are not cooked properly after the duration given in the cooking chart.</p>	<p>A different temperature from the one given in the recipe has been used.</p> <ul style="list-style-type: none"> ■ Select the temperature required for the recipe.
	<p>The ingredient quantities used are different from those given in the recipe.</p> <ul style="list-style-type: none"> ■ Check whether you have amended the recipe. The addition of more liquid or more eggs makes a moister mix which would take longer to cook.
<p>The browning of baked goods is uneven.</p>	<p>The wrong temperature or shelf level was selected.</p> <ul style="list-style-type: none"> ■ There will always be a slight unevenness in browning. If browning is very uneven, check whether the correct temperature and shelf level were selected.
	<p>The material or colour of the baking tin is not suitable for the oven function.</p> <ul style="list-style-type: none"> ■ When using the Conventional Heat  function, light coloured, shiny tins are not as suitable. Dark, matte tins are best for baking.
<p>Rust-like spots appear on catalytic surfaces.</p>	<p>The catalytic cleaning process does not remove spices, sugar and similar deposits.</p> <ul style="list-style-type: none"> ■ Take the catalytic panels out of the oven and remove this type of soiling with a mild solution of hot water and washing-up liquid applied with a soft brush (see “Cleaning and care – Cleaning the catalytic enamelled back panel”).

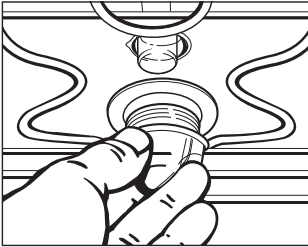
Problem solving guide

Problem	Possible cause and remedy
<p>The FlexiClip telescopic runners do not push in or pull out smoothly.</p>	<p>The bearings in the FlexiClip telescopic runners are not sufficiently lubricated.</p> <ul style="list-style-type: none"> ■ Lubricate the bearings with the special Miele lubricant. <p>Only the special Miele lubricant is designed to withstand the high temperatures in the oven compartment. Other lubricants may harden and stick to the FlexiClip telescopic runners when they are heated. You can obtain the special Miele lubricant from your Miele dealer or from Miele.</p>
<p>The top oven lighting does not switch on.</p> 	<p>The halogen lamp is faulty and needs replacing.</p> <div style="border: 1px solid gray; padding: 5px; margin: 5px 0;"> <p>⚠ Danger of burning! Make sure the oven heating elements are switched off. Make sure the oven compartment has cooled down.</p> </div> <ul style="list-style-type: none"> ■ Disconnect the appliance from the mains. Switch off at the wall and withdraw the plug from the socket, or switch off at the mains circuit breaker. ■ Turn the lamp cover a quarter turn anti-clockwise to release it and then pull it together with its seal downwards to take it out. ■ Replace the halogen lamp (Osram 66725 AM/A, 230 V, 25 W, G9). ■ Refit the lamp cover together with its seal and turn clockwise to secure. ■ Reconnect the oven to the electricity supply. <p>You have selected the Eco Fan Heat  function. The oven lighting does not switch on with this function.</p>

Contact in case of fault

In the event of any faults which you cannot remedy yourself, please contact Miele.

You can book a Miele customer service call-out online at www.miele.com.au/service or www.miele.co.nz/service.

Contact information for Miele can be found at the end of this booklet.

Please quote the model and serial number of your appliance when contacting Miele. This information can be found on the data plate.

This information is given on the data plate, visible on the front frame of the oven, with the door fully open.

For appliances with cooktop controls, also quote the model and serial number of the cooktop (see the separate operating and installation instructions included with the cooktop).

Warranty

The manufacturer's warranty for this appliance is 2 years.

For further information, please refer to your warranty booklet.

Installation

Building-in dimensions

Dimensions are given in mm.

Installation in a tall or base unit

When building the oven into a base unit underneath a cooktop, please also observe the installation instructions for the cooktop as well as the building-in height required for the cooktop.

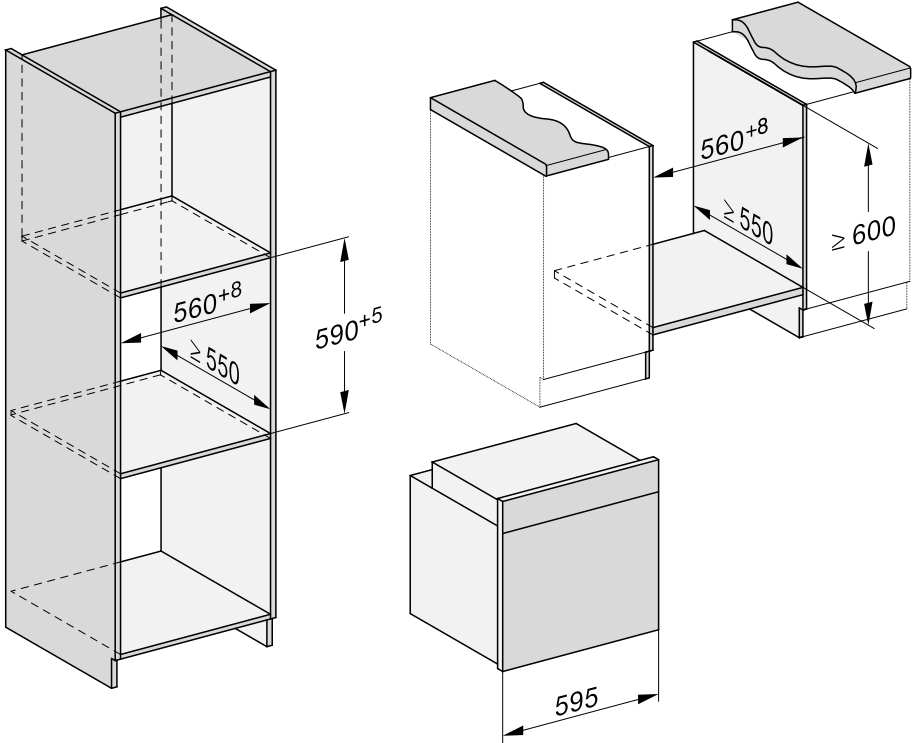

Side view H 22xx

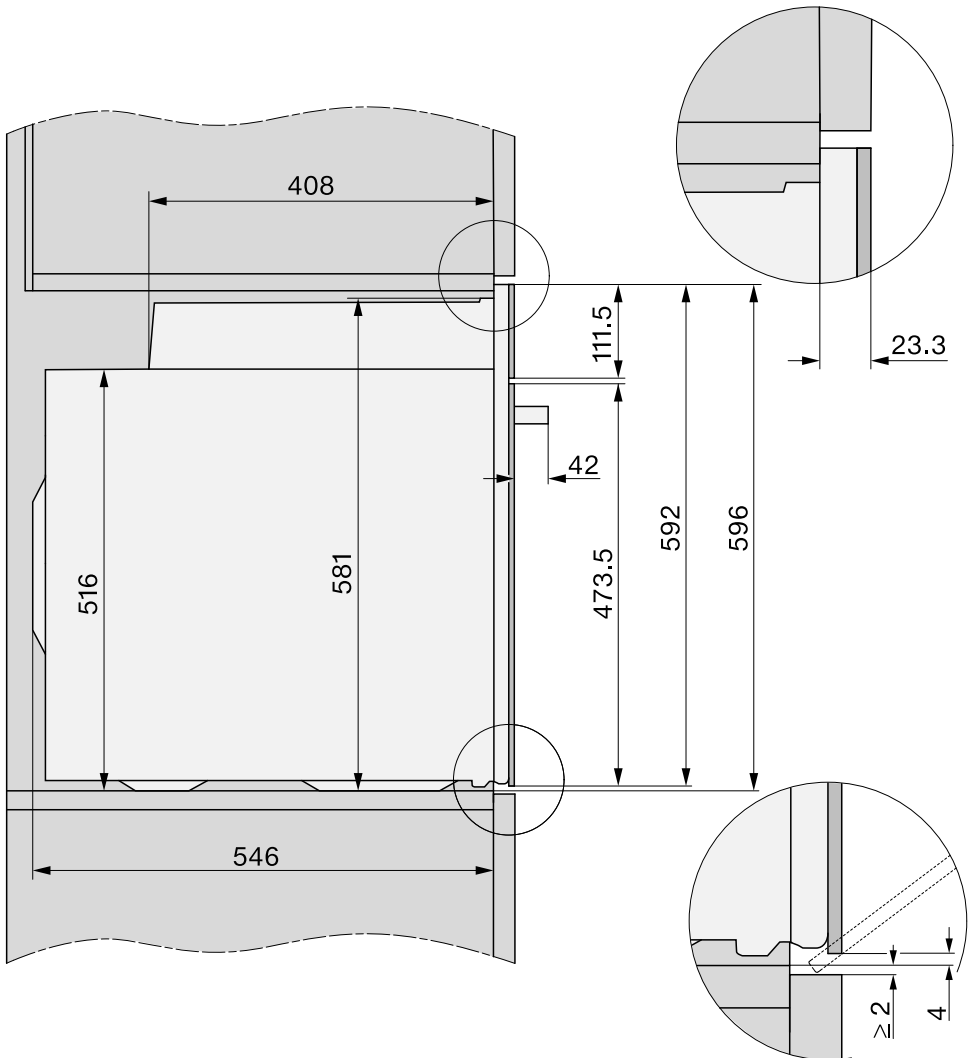

Installation

Side view H 25xx, H 27xx, H 28xx

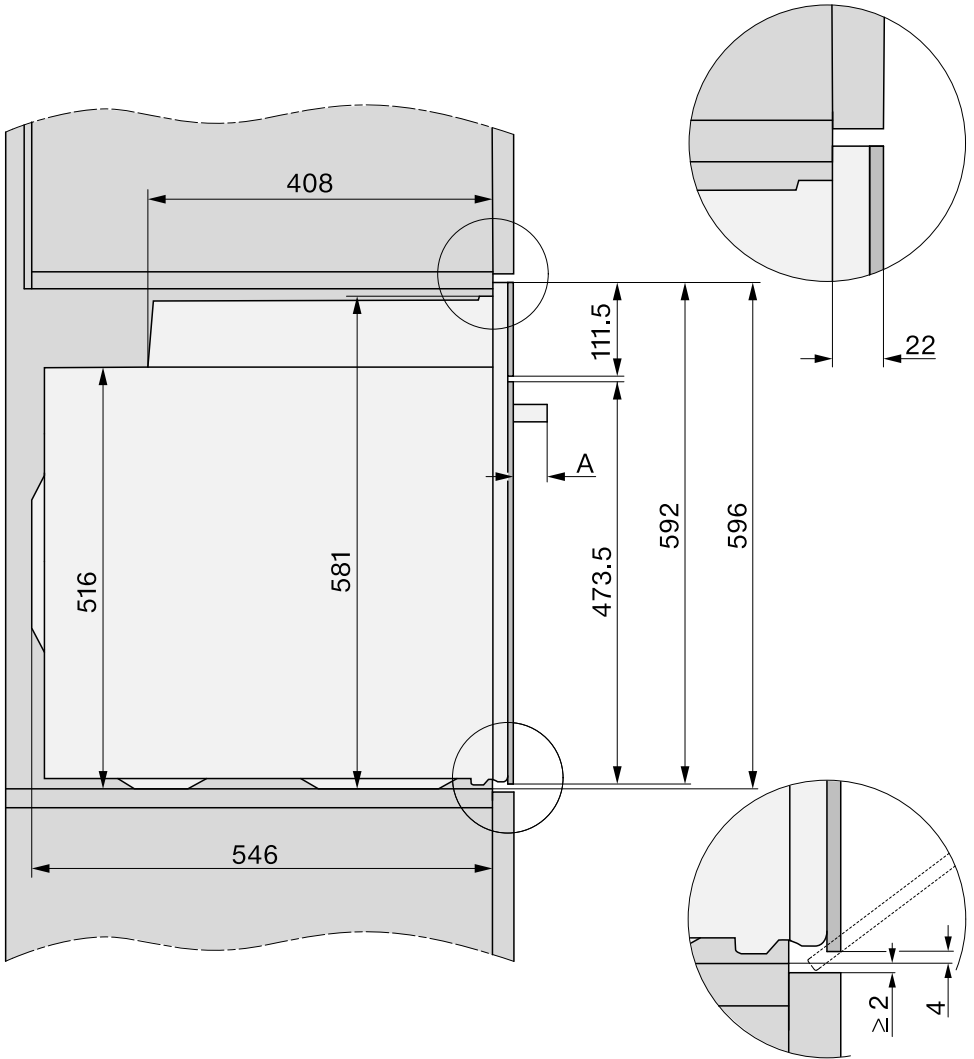

A H 25xx, H 27xx: 43 mm
H 28xx: 47 mm

Connections and ventilation

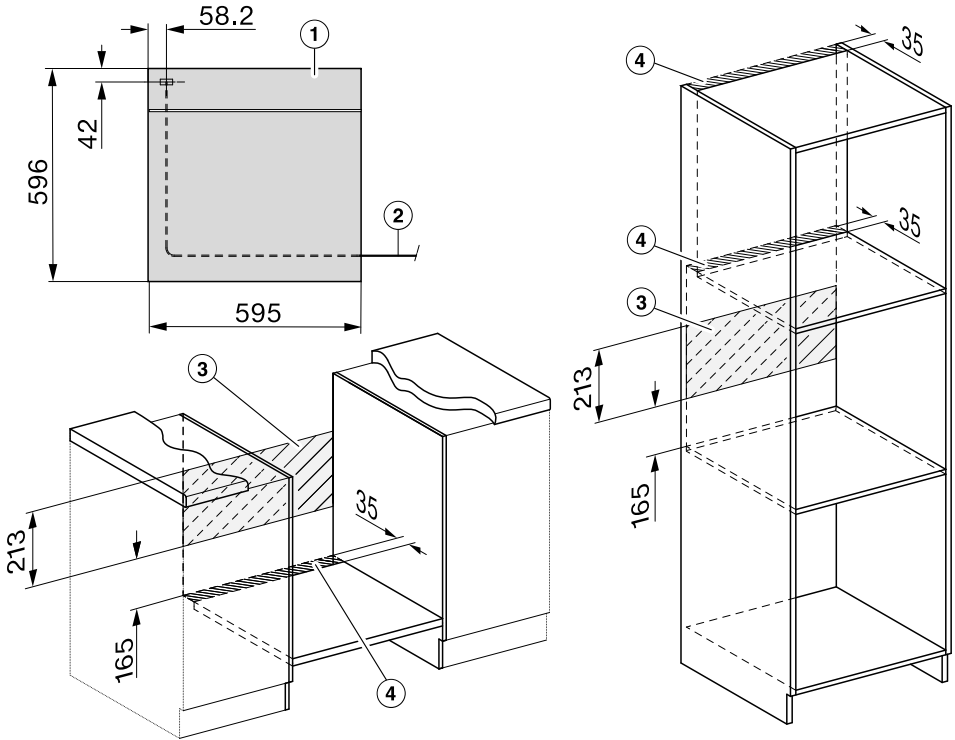

- ① Front view
- ② Mains connection cable, length = 1,500 mm
- ③ No connections permitted in this area
- ④ Ventilation cut-out, min. 150 cm²

Installation

Installing the cooker

For safety reasons, this appliance must only be used after it has been built in.

The cooker requires a sufficient supply of cool air for efficient operation. The required supply of cool air must not be excessively heated by other heat sources (e.g. solid fuel stoves).

The following must be observed when installing the appliance:

Make sure that the interim shelf that the oven sits on does not touch the wall.

Do not fit heat insulation strips to the side walls of the housing unit.

Before installation

- Ensure that there is no power to the mains socket.
- Follow the connection diagram supplied with the cooker.
- Remove the housing cover to connect the single conductors of the power cable to the connection terminals.

All H 2xxx I cookers that are combined with an induction cooktop are also supplied with a ferrite ring.

With the **exception** of the earth conductor, all other single conductors of the power cable must be fed through the opening of the ferrite ring before attaching them to the connection terminals.

- Secure the single conductors to the respective connection terminals.
- Replace the housing cover.

Installing the cooker

- Connect the cooker to the electrical supply.
- Place the cooker in front of the base unit.
- Insert the plug of the built-in cooktop into the connection on the cooker.

Lifting the oven by the door handle could cause damage to the door. Use the handle cut-outs on the side of the housing to lift the appliance.

It is a good idea to remove the door (see “Cleaning and care - Removing the door”) and the accessories before installing the appliance. This makes the cooker lighter when you push it into the housing unit and you do not run the risk of lifting it by the door handle.

- Push the cooker into the base unit and align it.
- Open the door (if you have not removed it previously).

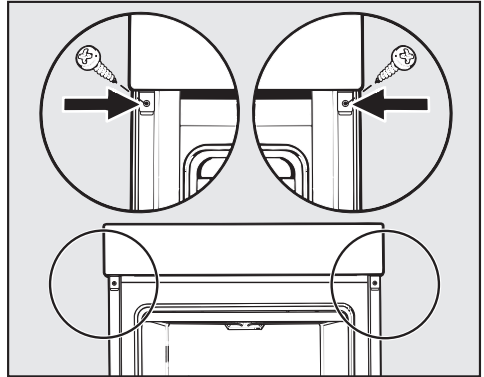

- Secure the cooker to the side walls of the housing unit using the screws supplied.
- Refit the door, if necessary (see “Cleaning and care - Refitting the door”).

Installation

Installing the oven

For safety reasons, the oven may only be used after it has been fully installed.

The oven requires a sufficient supply of cool air for efficient operation. The required supply of cool air must not be excessively heated by other heat sources (e.g. solid fuel stoves).

The following must be observed when installing the appliance:
Make sure that the shelf that the oven sits on does not touch the wall.
Do not fit heat insulation strips to the side walls of the housing unit.

- Connect the mains cable from the oven to the electricity supply.

Do not carry the oven by the door handle. The door can be damaged.
Use the handle cut-outs on the side of the housing to lift the appliance.

It is a good idea to remove the door (see "Cleaning and care - Removing the door") and the accessories before installing the appliance. This makes the oven lighter when you push it into the housing unit and you do not run the risk of lifting it by the door handle by mistake.

- Push the oven into the housing unit and align it.
- Open the door, if you have not removed it.

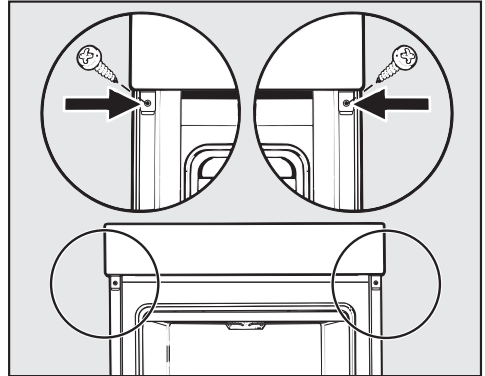

- Use the screws supplied to secure the oven to the side walls of the housing unit.
- Refit the door, if necessary (see "Cleaning and care - Fitting the door").

Electrical connection



Danger of injury!

Miele cannot be held liable for unauthorised installation, maintenance and repair work as this can be dangerous to users.

Connection to the electrical mains may only be carried out by a qualified electrician in accordance with national and local regulations and the additional regulations of the local electrical supply companies.

Connection of this appliance must comply with national and local safety regulations.

Connection to a switched socket is recommended as this provides easier access in the case of a service call.

If the appliance is **hardwired** or if the switch is not accessible after installation, an additional means of disconnection must be provided for all poles.

Suitable means of disconnection include switches with an all-pole contact gap of at least 3 mm. These include isolator switches, fuses and relays.

Voltage, rated load and fuse rating are given on the data plate situated at the front of the oven compartment. Please ensure the connection data matches the household supply.

When contacting Miele, please quote the following:

- Model number
- Serial number

- Connection data (voltage/frequency/maximum rated load)

If the mains connection cable is damaged, it must be replaced by a suitably qualified electrician with a specialist connection cable of type H 05 VV-F, available from Miele, in order to avoid a hazard.

Temporary or permanent operation with a self-sufficient or non-mains synchronous energy supply system (e.g. isolated networks, back-up systems) is possible. A requirement for the operation is that the energy supply system complies with all current local and national requirements that apply to stand-alone, solar and/or battery systems.

The protective measures provided in the domestic installation and in this Miele product must also be assured in their function and operation in isolated operation or in non-mains synchronous operation, or replaced with equivalent measures in the installation.

Wiring diagram



N.B. This appliance is supplied single phase only in AUS/NZ. The appliance must only be connected in accordance with the options below which include a neutral conductor (see wiring diagrams in thick-framed box). The two connection options below the thick-framed box are not permitted in AUS/NZ.

Installation

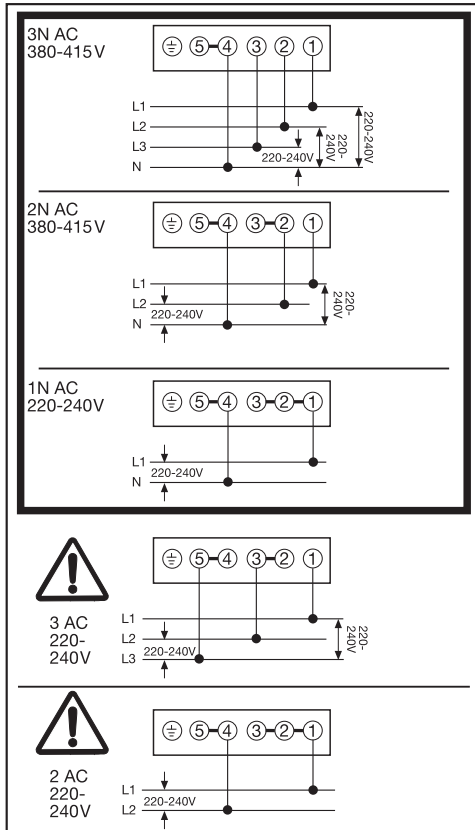

Cooker

Cookers with integrated cooktop controls are supplied with a connection cable.

The cooker must be connected to the mains supply using a type H 05 VV-F mains cable only, with a suitable cross-sectional area (CSA) according to the diagrams shown.

Maximum rated load: see data plate.

Possible combination cooktops

Miele cookers with integrated cooktop controls may only be combined with cooktops as specified by Miele for use with that cooker.

Contact Miele for further information on suitable combinations.



















Oven





Ovens are supplied with a 3-core cable for connection to a 230 V, 50 Hz alternating current supply.

Fuse rating is 16 A.

Maximum rated load: see data plate.

Creamed mixture

Cakes/Biscuits (accessories)		🌡️ [°C]	 5		🕒 [min.]
			+HFC	-HFC	
Muffins (1 tray)		150–160	1	2	25–35
Muffins (2 trays)		150–160	1+3 ³	1+3	30–40 ⁴
Small cakes (1 tray)		150	1	2	25–35
		160 ²	2	3	20–30
Small cakes (2 trays)		150 ²	1+3 ³	1+3	25–35
Sand cake (rack, loaf tin, 30 cm) ¹		150–160	1	2	60–70
		155–165 ²	1	2	60–70
Marble, nut cake (rack, loaf tin, 30 cm) ¹		150–160	1	2	55–65
		150–160	1	2	60–70
Marble, nut cake (rack, ring tin/Bundt cake tin, Ø 26 cm) ¹		150–160	1	2	55–65
		150–160	1	2	55–65
Fresh fruit cake (1 tray)		160–170	1	2	45–55
		155–165	1	1	45–55
Fresh fruit cake (rack, springform cake tin, Ø 26 cm) ¹		150–160	1	2	55–65
		170–180 ²	1	1	35–45
Flan base (rack, flan base tin, Ø 28 cm) ¹		150–160	1	2	25–35
		170–180 ²	1	2	15–25

 Function, 🌡️ Temperature,  Shelf level (+HFC with FlexiClip telescopic runners HFC 70-C / -HFC without FlexiClip telescopic runners HFC 70-C), 🕒 Cooking duration,  Fan Plus,  Conventional Heat

- 1 Use a dark coloured, matte baking tin and place it centrally on the rack.
- 2 Pre-heat the oven before placing the food inside. Do not use the Booster  function for this purpose.
- 3 Fit the FlexiClip telescopic runners HFC 70-C (if available) onto the bottom shelf level.
- 4 Take the baking trays out of the oven early if the food has already browned sufficiently before the specified cooking time has elapsed.

Cooking charts



















Rubbed in mixture





Cakes/Biscuits (accessories)		Temperature [°C]	Shelf level ⁵		Cooking duration [min.]
			+HFC	-HFC	
Cookies (1 tray)		140–150	1	2	20–30
		150–160	1	2	25–35
Cookies (2 trays)		140–150	1+3 ³	1+3	20–30 ⁴
Drop cookies (1 tray)		140	1	2	35–45
		160 ²	2	3	20–30
Drop cookies (2 trays)		140	1+3 ³	1+3	40–50 ⁴
Flan base (rack, flan base tin, Ø 28 cm) ¹		150–160	1	2	35–45
		170–180 ²	1	2	20–30
Cheesecake (rack, springform cake tin, Ø 26 cm) ¹		170–180	1	2	80–90
		150–160	1	2	80–90
Apple pie (rack, springform cake tin, Ø 20 cm) ¹		160	1	2	80–100
		180	1	1	75–95
Apple pie (rack, springform cake tin, Ø 26 cm) ¹		180–190 ²	1	2	60–70
		160–170	1	2	60–70
Fresh fruit cake, glazed (rack, springform cake tin, Ø 26 cm) ¹		170–180	1	2	60–70
		150–160	1	2	55–65
Fresh fruit cake, glazed (1 tray)		170–180	1	2	50–60
		160–170	1	2	45–55
Fruit flan (1 tray)		210–220 ²	–	1	55–65
		180–190	–	1	35–45
Scones (2 x aluminium tray on rack, 4 x 4 pieces on each tray)		180–190 ²	–	1+3	15–20 ⁴

Function, Temperature, Shelf level (+HFC with FlexiClip runners HFC 70-C / -HFC without FlexiClip telescopic runners HFC 70-C), Cooking duration, Fan Plus, Eco Fan Heat, Conventional Heat, Intensive Bake

- 1 Use a dark coloured, matte baking tin and place it centrally on the rack.
- 2 Pre-heat the oven before placing the food inside. Do not use the Booster function for this purpose.
- 3 Fit the FlexiClip telescopic runners HFC 70-C (if available) onto the bottom shelf level.
- 4 Take the baking trays out of the oven early if the food has already browned sufficiently before the specified cooking time has elapsed.

Yeast dough

Cakes/Biscuits (accessories)		🌡️ [°C]	 ⁵		🕒 [min.]
			+HFC	-HFC	
Bundt cake (rack, Bundt cake tin, Ø 24 cm) ¹		150–160	1	2	50–60
		160–170	1	1	50–60
Stollen (1 tray)		150–160	1	2	55–65
		160–170	1	2	55–65
Streusel cake with/without fruit (1 tray)		160–170	1	2	40–50
		170–180	2	3	45–55
Fresh fruit cake (1 tray)		160–170	1	2	45–55
		170–180	2	3	45–55
Apple turnovers/raisin scrolls (1 tray)		160–170	1	2	25–35
Apple turnovers/raisin scrolls (2 trays)		160–170	1+3 ³	1+3	30–40 ⁵
White bread, free form (1 tray)		180–190	1	2	35–45
		190–200	1	2	30–40
White bread (rack, loaf tin, 30 cm) ¹		180–190	1	2	35–45
		190–200 ²	1	2	30–40
Wholegrain bread (rack, loaf tin, 30 cm) ¹		180–190	1	2	55–65
		200–210 ²	1	2	45–55
Prove yeast dough (rack)		30–35	- ⁴	- ⁴	-

 Function, 🌡️ Temperature, ⁵ Shelf level (+HFC with FlexiClip telescopic runners HFC 70-C / -HFC without FlexiClip telescopic runners HFC 70-C), 🕒 Cooking duration,  Fan Plus,  Conventional Heat

- 1 Use a dark coloured, matte baking tin and place it centrally on the rack.
- 2 Pre-heat the oven before placing the food inside. Do not use the Booster  function for this purpose.
- 3 Fit the FlexiClip telescopic runners HFC 70-C (if available) onto the bottom shelf level.
- 4 Place the rack on the floor of the oven, and stand the bowl with the dough on the rack. Depending on the size of the dish, you may need to remove the shelf runners.
- 5 Take the baking trays out of the oven early if the food has already browned sufficiently before the specified cooking time has elapsed.

Cooking charts

Quark dough

Cakes/Biscuits (accessories)		Temperature [°C]	Shelf level ⁵ ₁		Cooking duration [min.]
			+HFC	-HFC	
Fresh fruit cake (1 tray)		160–170	1	2	40–50
		170–180	2	3	50–60
Apple turnovers/raisin scrolls (1 tray)		160–170	2	3	25–35
Apple turnovers/raisin scrolls (2 trays)		150–160	1+3 ¹	1+3	25–35 ²

Function, Temperature, Shelf level (+HFC with FlexiClip telescopic runners HFC 70-C / -HFC without FlexiClip telescopic runners HFC 70-C), Cooking duration, Fan Plus, Conventional Heat

- 1 Fit the FlexiClip telescopic runners HFC 70-C (if available) onto the bottom shelf level.
- 2 Take the baking trays out of the oven early if the food has already browned sufficiently before the specified cooking time has elapsed.









Sponge mixture



Cakes/Biscuits (accessories)		Temperature [°C]	Shelf level ⁵ ₁		Cooking duration [min.]
			+HFC	-HFC	
Sponge cake base (2 eggs) (rack, springform cake tin, Ø 26 cm) ¹		160–170 ²	1	2	15–25
Sponge cake base (4–6 eggs) (rack, springform cake tin, Ø 26 cm) ¹		150–160 ²	1	2	30–40
Whisked sponge (rack, springform cake tin, Ø 26 cm) ¹		180	1	2	25–35
		150–170 ²	1	2	25–45
Sponge cake base (1 tray)		180–190 ²	1	2	15–25

Function, Temperature, Shelf level (+HFC with FlexiClip telescopic runners HFC 70-C / -HFC without FlexiClip telescopic runners HFC 70-C), Cooking duration, Fan Plus, Conventional Heat

- 1 Use a dark coloured, matte baking tin and place it centrally on the rack.
- 2 Pre-heat the oven before placing the food inside. Do not use the Booster function for this purpose.

Choux pastry, puff pastry, meringue

Cakes/Biscuits (accessories)		🌡️ [°C]	 5 1		🕒 [min.]
			+HFC	-HFC	
Choux buns (1 tray)		160–170	1	2	30–40
Pastry puffs (1 tray)		180–190	1	2	20–30
Pastry puffs (2 trays)		180–190	1+3 ¹	1+3	20–30 ²
Macaroons (1 tray)		120–130	1	2	25–50
Macaroons (2 trays)		120–130	1+3 ¹	1+3	25–50 ²
Meringues/pavlovas (1 tray of 6, each Ø 6 cm)		80–100	1	2	120–150
Meringues/pavlovas (2 trays of 6, each Ø 6 cm)		80–100	1+3 ¹	1+3	150–180

 Function, 🌡️ Temperature,  Shelf level (+HFC with FlexiClip telescopic runners HFC 70-C / -HFC without FlexiClip telescopic runners HFC 70-C), 🕒 Cooking duration,  Fan Plus

¹ Fit the FlexiClip telescopic runners HFC 70-C (if available) onto the bottom shelf level.

² Take the baking trays out of the oven early if the food has already browned sufficiently before the specified cooking time has elapsed.

Cooking charts

















Savoury snacks

Food (accessories)		Temperature [°C]	Shelf level ⁵		Cooking duration [min.]
			+HFC	-HFC	
Savoury flan (1 tray)		220–230 ¹	–	1	25–35
		180–190	–	1	30–40
Onion tart (1 tray)		180–190 ¹	1	2	25–35
		170–180	1	2	30–40
Pizza, yeast dough (1 tray)		170–180	1	2	25–35
		210–220 ¹	1	2	20–30
Pizza, yeast dough (1 aluminium Pizza dish Ø 35 cm on rack)		200 ¹	–	1	14–16
Pizza, quark dough (1 tray)		170–180	1	2	25–35
		190–200 ¹	1	2	25–35
Frozen pizza, pre-cooked (rack)		200–210	1	2	20–25
Toast (rack)		250	–	3	5–8
Baked dishes/gratins (e.g. toast) (rack on universal tray)		250 ²	2	3	3–6
Grilled vegetables (rack on universal tray)		250 ²	3	4	5–10 ³
		250 ²	3	3	5–10 ³
Ratatouille (1 universal tray)		180–190	1	2	40–60



Function, Temperature, Shelf level (+HFC with FlexiClip telescopic runners HFC 70-C / -HFC without FlexiClip telescopic runners HFC 70-C), Cooking duration, Conventional Heat, Intensive Bake, Fan Plus, Eco Fan Heat, Full Grill, Fan Grill

- 1 Pre-heat the oven before placing the food inside. Do not use the Booster function for this purpose.
- 2 Pre-heat the oven for 5 minutes before placing the food inside. Do not use the Booster function for this purpose.
- 3 If possible, turn the food halfway through the cooking duration.

Beef















Food (accessories)		 [°C]	 ⁵ ₁	 [min.]	 ¹⁰ [°C]
Braised beef, approx. 1 kg (oven dish with lid)	 ²	150–160 ³	2 ⁶	120–130 ⁷	--
	 ²	170–180 ³	2 ⁶	120–130 ⁷	--
	 ²	180–190	2 ⁶	160–180 ⁸	--
Fillet of beef, approx. 1 kg (universal tray)	 ²	180–190 ³	2 ⁶	25–60	53–75
Fillet of beef, "rare", approx. 1 kg ¹	 ²	80–85 ⁴	2 ⁶	70–80	53–55
Fillet of beef, "medium", approx. 1 kg ¹	 ²	90–95 ⁴	2 ⁶	80–90	60–65
Fillet of beef, "well-done", approx. 1 kg ¹	 ²	95–100 ⁴	2 ⁶	110–130	70–75
Sirloin joint, approx. 1 kg (universal tray)	 ²	180–190 ³	2 ⁶	35–65	53–75
Sirloin joint, "rare", approx. 1 kg ¹	 ²	80–85 ⁴	2 ⁶	80–90	53–55
Sirloin joint, "medium", approx. 1 kg ¹	 ²	90–95 ⁴	2 ⁶	110–120	60–65
Sirloin joint, "well-done", approx. 1 kg ¹	 ²	95–100 ⁴	2 ⁶	130–140	70–75
Burger, rissoles (rack on shelf level 4 and universal tray on shelf level 1)	 ²	250 ⁵	4	15–25 ⁹	--

 Function,
  Temperature,
  ⁵₁ Shelf level,
  Cooking duration,
  Core temperature,
  Fan Plus,
  Conventional Heat,
  Eco Fan Heat,
  Full Grill

- 1 Use the rack and the universal tray.
- 2 Sear the meat on the cooktop first.
- 3 Pre-heat the oven before placing the food inside. Do not use the Booster  function for this purpose.
- 4 Pre-heat the oven at 120 °C for 15 minutes. Reduce the temperature when you place the food in the oven.
- 5 Pre-heat the oven for 5 minutes before placing the food inside. Do not use the Booster  function for this purpose.
- 6 Fit the FlexiClip telescopic runners HFC 70-C (if available).
- 7 Roast with the lid on first. Remove the lid after roasting for 90 minutes and add approx. 0.5 litre of liquid.
- 8 Roast with the lid on first. Remove the lid after roasting for 100 minutes and add approx. 0.5 litre of liquid.
- 9 If possible, turn the food halfway through the cooking duration.
- 10 If you have a separate food probe you can use the core temperature shown.

Cooking charts

















Veal

Food (accessories)		 [°C]	 ⁵ ₁	 [min.]	 ⁷ [°C]
Braised veal, approx. 1.5 kg (roasting dish with lid)	 ²	160–170 ³	2 ⁵	120–130 ⁶	--
	 ²	170–180 ³	2 ⁵	120–130 ⁶	--
Fillet of veal, approx. 1 kg (universal tray)	 ²	160–170 ³	2 ⁵	30–60	53–75
Fillet of veal, “rare”, approx. 1 kg ¹	 ²	80–85 ⁴	2 ⁵	50–60	53–55
Fillet of veal, “medium”, approx. 1 kg ¹	 ²	90–95 ⁴	2 ⁵	80–90	60–65
Fillet of veal, “well-done”, approx. 1 kg ¹	 ²	95–100 ⁴	2 ⁵	90–100	70–75
Saddle of veal, “rare”, approx. 1 kg ¹	 ²	80–85 ⁴	2 ⁵	80–90	53–55
Saddle of veal, “medium”, approx. 1 kg ¹	 ²	90–95 ⁴	2 ⁵	100–130	60–65
Saddle of veal, “well-done”, approx. 1 kg ¹	 ²	95–100 ⁴	2 ⁵	130–140	70–75

 Function,  Temperature,  ⁵₁ Shelf level,  Cooking duration,  Core temperature,  Fan Plus,  Conventional Heat

- 1 Use the rack and the universal tray.
- 2 Sear the meat on the cooktop first.
- 3 Pre-heat the oven before placing the food inside. Do not use the Booster  function for this purpose.
- 4 Pre-heat the oven at 120 °C for 15 minutes. Reduce the temperature when you place the food in the oven.
- 5 Fit the FlexiClip telescopic runners HFC 70-C (if available).
- 6 Roast with the lid on first. Remove the lid after roasting for 90 minutes and add approx. 0.5 litre of liquid.
- 7 If you have a separate food probe you can use the core temperature shown.

Pork











Food (accessories)		 [°C]	 ⁵ ₁	 [min.]	 ¹⁰ [°C]
Pork joint/pork neck roast, approx. 1 kg (oven dish with lid)		160–170	2 ⁵	130–140 ⁶	80–90
		170–180	2 ⁵	130–140 ⁶	80–90
Pork joint with crackling, approx. 2 kg (oven dish)		180–190	2 ⁵	130–150 ⁷	80–90
		190–200	2 ⁵	130–150 ⁷	80–90
Fillet of pork, approx. 350 g ¹	 ²	90–100 ³	2 ⁵	70–90	60–75
Ham roast, approx. 1.5 kg (oven dish with lid)		160–170	2 ⁵	130–160 ⁸	80–90
Gammon joint, approx. 1 kg (universal tray)		150–160	2 ⁵	50–60	75–80
Gammon joint, approx. 1 kg ¹	 ²	95–105 ³	2 ⁵	140–160	75–80
Meat loaf, approx. 1 kg (universal tray)		170–180	2 ⁵	60–70 ⁷	80–85
		190–200	2 ⁵	70–80 ⁷	80–85
Bacon ¹		250 ⁴	4	3–5	--
Sausage ¹		250 ⁴	3 ⁵	8–15 ⁹	--





 Function,
  Temperature,
  ⁵₁ Shelf level,
  Cooking duration,
  Core temperature,
  Fan Plus,
  Conventional Heat,
  Eco Fan Heat,
  Full Grill

- 1 Use the rack and the universal tray.
- 2 Sear the meat on the cooktop first.
- 3 Pre-heat the oven at 120 °C for 15 minutes. Reduce the temperature when you place the food in the oven.
- 4 Pre-heat the oven for 5 minutes before placing the food inside. Do not use the Booster  function for this purpose.
- 5 Fit the FlexiClip telescopic runners HFC 70-C (if available).
- 6 Roast with the lid on first. Remove the lid after roasting for 60 minutes and add approx. 0.5 litre of liquid.
- 7 Add approx. 0.5 l of liquid halfway through roasting.
- 8 Roast with the lid on first. Remove the lid after roasting for 100 minutes and add approx. 0.5 litre of liquid.
- 9 If possible, turn the food halfway through the cooking duration.
- 10 If you have a separate food probe you can use the core temperature shown.

Cooking charts















Lamb, game









Food (accessories)		 [°C]	 5 1	 [min.]	 6 [°C]
Leg of lamb on the bone, approx. 1.5 kg (oven dish with lid)		170–180	2 ⁴	100–120 ⁵	53–75
Saddle of lamb, off the bone (universal tray)	 1	180–190 ²	2 ⁴	10–20	53–75
Saddle of lamb, off the bone (rack and universal tray)	 1	95–105 ³	2 ⁴	40–60	53–75
Saddle of venison, off the bone (universal tray)	 1	160–170 ²	2 ⁴	70–90	54–57
Roebuck saddle, off the bone (universal tray)	 1	140–150 ²	2 ⁴	25–35	60–81
Leg of wild boar, off the bone, approx. 1 kg (oven dish with lid)	 1	170–180	2 ⁴	100–120 ⁵	80–90



 Function,  Temperature,  Shelf level,  Cooking duration,  Core temperature,  Conventional Heat

- 1 Sear the meat on the cooktop first.
- 2 Pre-heat the oven before placing the food inside. Do not use the Booster  function for this purpose.
- 3 Pre-heat the oven at 120 °C for 15 minutes. Reduce the temperature when you place the food in the oven.
- 4 Fit the FlexiClip telescopic runners HFC 70-C (if available).
- 5 Roast with the lid on first. Remove the lid after roasting for 50 minutes and add approx. 0.5 litre of liquid.
- 6 If you have a separate food probe you can use the core temperature shown.

Poultry, fish

Food (accessories)		 Temperature [°C]	 Shelf level ⁵	 [min.]	 Core temperature ⁷ [°C]
Poultry, 0.8–1.5 kg (universal tray)		170–180	2 ³	55–65	85–90
Chicken, approx. 1.2 kg (rack on universal tray)		180–190 ¹	2 ³	55–65 ⁴	85–90
Poultry, approx. 2 kg (oven dish)		180–190	2 ³	100–120 ⁵	85–90
		190–200	2 ³	110–130 ⁵	85–90
Poultry, approx. 4 kg (oven dish)		160–170	2 ³	180–200 ⁶	90–95
		180–190	2 ³	180–200 ⁶	90–95
Fish, 200–300 g (e.g. trout) (universal tray)		210–220 ²	2 ³	15–25	75–80
Fish, 1–1.5 kg (e.g. Australian salmon) (universal tray)		210–220 ²	2 ³	30–40	75–80
Fish fillet in foil, 200–300 g (universal tray)		200–210	2 ³	25–30	75–80

 Function,  Temperature,  Shelf level⁵,  Cooking duration,  Core temperature,  Fan Plus,  Fan Grill,  Conventional Heat,  Eco Fan Heat

- 1 Pre-heat the oven for 5 minutes before placing the food inside. Do not use the Booster  function for this purpose.
- 2 Pre-heat the oven before placing the food inside. Do not use the Booster  function for this purpose.
- 3 Fit the FlexiClip telescopic runners HFC 70-C (if available).
- 4 If possible, turn the food halfway through the cooking duration.
- 5 Add approx. 0.25 litre of liquid at the start.
- 6 Add approx. 0.5 litre of liquid after 30 minutes.
- 7 If you have a separate food probe you can use the core temperature shown.

Miele Australia Pty. Ltd.

ACN 005 635 398
ABN 96 005 635 398

Miele Head Office Melbourne:

Level 4, 141 Camberwell Road
Hawthorn East, VIC 3123

Miele Experience Centre Doncaster:

1136/7 Doncaster Shopping Centre
619 Doncaster Rd, Doncaster, VIC 3108

Miele Experience Centre South Melbourne:

206-210 Coventry Street
South Melbourne, VIC 3205

Miele Experience Centre and Office Sydney:

3 Skyline Place
Frenchs Forest, NSW 2086

Miele Experience Centre and Office Brisbane:

Tenancy 4C, 63 Skyring Terrace
Newstead, QLD 4006

Miele Experience Centre Gold Coast:

131 Ferry Road
Southport, QLD 4215

Miele Experience Centre and Office Adelaide:

83-85 Sir Donald Bradman Drive
Hilton, SA 5033

Miele Experience Centre and Office Perth:

205-207 Stirling Highway
Claremont, WA 6010

1300 464 353 (1300 4 MIELE)

www.miele.com.au

Miele New Zealand Limited

IRD 98 463 631

**Miele Experience Centre
and Head Office Auckland:**

8 College Hill
Freemans Bay, Auckland 1011

**Miele Experience Centre
Wellington:**

183 Featherston Street
Wellington 6011

0800 464 353 (0800 4 MIELE)

www.miele.co.nz

**Miele Global Headquarters
Germany**

Miele & Cie. KG

Carl-Miele-Straße 29
33332 Gütersloh
Federal Republic of Germany

H 2265-1 B, H 2265-1 E, H 2265-1 I, H 2267-1 B, H 2760 B,
H 2860 B, H 2850 B