

DE'LONGHI

COOKING

**INSTALLATION and SERVICE INSTRUCTIONS
USE and CARE INSTRUCTIONS**

ELECTRIC BUILT-IN OVENS

distributed by
DeLonghi Australia Pty Ltd
DeLonghi New Zealand Ltd



Dear Customer,

Thank you for having purchased and given your preference to our product.

The safety precautions and recommendations reported below are for your own safety and that of others. They will also provide a means by which to make full use of the features offered by your appliance.

Please keep this booklet in a safe place. It may be useful in future, either to yourself or to others in the event that doubts should arise relating to its operation.

This appliance must be used only for the task it has explicitly been designed for, that is for cooking foodstuffs. Any other form of usage is to be considered as inappropriate and therefore dangerous.

The manufacturer declines all responsibility in the event of damage caused by improper, incorrect or illogical use of the appliance or by faulty installation.

This appliance has been designed and constructed in accordance with the following codes and specifications:

AS/NZS 60335.1 General Requirements for Domestic electrical appliances

AS/NSZ 60335.2.6 Particular Requirements for Domestic electrical cooking appliances

AS/NZS CISPR 14.1 Electromagnetic Compatibility Requirements

PRODUCT LABEL



IMPORTANT SAFETY PRECAUTIONS AND RECOMMENDATIONS

IMPORTANT: This appliance is designed and manufactured solely for the cooking of domestic (household) food and is not suitable for any non domestic application and therefore should not be used in a commercial environment.

The appliance guarantee will be void if the appliance is used within a non domestic environment i.e. a semi commercial, commercial or communal environment.

Read the instructions carefully before installing and using the appliance.

- This appliance has been designed and manufactured in compliance with the applicable standards for the household cooking products and it fulfills all the safety requirements shown in this manual, including those for surface temperatures. Some people with sensitive skin may have a more pronounced temperature perception with some components although these parts are within the limits allowed by the norms. The complete safety of the appliance also depends on the correct use, we therefore recommend to always pay a extreme attention while using the product, especially in the presence of children.
- After having unpacked the appliance, check to ensure that it is not damaged and that the oven door closes correctly. In case of doubt, do not use it and consult your supplier or a professionally qualified technician.
- Packing elements (i.e. plastic bags, polystyrene foam, nails, packing straps, etc.) should not be left around within easy reach of children, as these may cause serious injuries.
- Some appliances are supplied with a protective film on steel and aluminium parts. **This film must be removed before using the appliance.**
- **IMPORTANT:** The use of suitable protective clothing/gloves is recommended when handling or cleaning this appliance.

- Do not attempt to modify the technical characteristics of the appliance as this may become dangerous to use. The manufacturer declines all responsibility for any inconvenience resulting from the inobservance of this condition.
- Do not operate your appliance by means of an external timer or separate remote-control system.
- Do not carry out cleaning or maintenance operations on the appliance without having previously disconnected it from the electric power supply.
- **WARNING:** Ensure that the appliance is switched off before replacing the oven lamp to avoid the possibility of electric shock.
- Do not use a steam cleaner because the moisture can get into the appliance therefore making it unsafe.
- Do not touch the appliance with wet or damp hands (or feet).
- Do not use the appliance whilst in bare feet.
- If you should decide not to use this appliance any longer (or decide to substitute another model), before disposing of it, it is recommended that it be made inoperative in an appropriate manner in accordance to health and environmental protection regulations, ensuring in particular that all potentially hazardous parts be made harmless, especially in relation to children who could play with unused appliances.
- The various components of the appliance are recyclable. Dispose of them in accordance with the regulations in force in your country. If the appliance is to be scrapped, remove the power cord.
- After use, ensure that the knobs are in the off position.
- Children less than 8 years of age shall be kept away unless continuously supervised.
- This appliance can be used by children aged from 8 years and above and persons with reduced physical, sensory or mental capabilities or lack of experience and knowledge if they have been given supervision or instruction concerning use of the appliance in a safe way and understand the hazards involved. Children shall not play with the appliance. Cleaning and user maintenance shall not be made by children without supervision.

- The manufacturer declines all liability for injury to persons or damage to property caused by incorrect or improper use of the appliance.
- **WARNING:** During use the appliance and its accessible parts become hot; they remain hot for some time after use.
 - Care should be taken to avoid touching heating elements inside the oven.
 - The door is hot, use the handle.
 - To avoid burns and scalds, young children should be kept away.
- Make sure that electrical cables connecting other appliances in the proximity of the oven cannot become entrapped in the oven door.
- **WARNING:** When correctly installed, your product meets all safety requirements laid down for this type of product category. However special care should be taken around the rear or the underneath of the appliance as these areas are not designed or intended to be touched and may contain sharp or rough edges, that may cause injury.
- **FIRST USE OF THE OVEN** - it is advised to follow these instructions:
 - Furnish the interior of the oven as described in the chapter “CLEANING AND MAINTENANCE”.
 - Switch on the empty oven on max to eliminate grease from the heating elements.
 - Disconnect the appliance from the electrical power supply, let the oven cool down and clean the interior of the oven with a cloth soaked in water and neutral detergent; then dry carefully.
- **CAUTION:** Do not use harsh abrasive cleaners or sharp metal scrapers to clean the oven door glass since they can scratch the surface, which may result in shattering of the glass.
- Do not line the oven walls with aluminium foil. Do not place baking trays or the drip tray on the base of the oven chamber.
- **FIRE RISK!** Do not store flammable material in the oven.

- Always use oven gloves when removing the shelves and food trays from the oven whilst hot.
- Do not hang towels, dishcloths or other items on the appliance or its handle – as this could be a fire hazard.
- Clean the oven regularly and do not allow fat or oils to build up in the oven base or tray. Remove spillages as soon as they occur.
- Do not stand on the open oven door.
- Always stand back from the appliance when opening the oven door to allow steam and hot air to escape before removing the food.
- **SAFE FOOD HANDLING:** Leave food in the oven for as short a time as possible before and after cooking. This is to avoid contamination by organisms which may cause food poisoning. Take particular care during warmer weather.
- **WARNING:** Take care NOT to lift the appliance by the door handle.
- The appliance must not be installed behind a decorative door in order to avoid overheating.
- The oven accessories (e.g. oven wire rack) must be fitted correctly as indicated at page 16.
- If the power supply cable is damaged, it must be replaced only by an authorized service agent in order to avoid a hazard.

INSTALLATION

CAUTION:

- This appliance must be installed in accordance with these installation instructions.
- This appliance shall only be serviced by authorised personnel.
- This appliance is to be installed only by an authorised person in compliance with the current electrical regulations and in observation of the instructions supplied by the manufacturer.
Failure to comply with this condition will render the guarantee invalid.
- Incorrect installation, for which the manufacturer accepts no responsibility, may cause personal injury or damage.
- Always disconnect the appliance from mains power supply before carrying out any maintenance operations or repairs.

FITTING REQUIREMENTS

- The oven can be fitted in standard units, 60 cm width and depth.
- Installation requires a compartment as illustrated in figures 1 and 2.
- On the lower side, the oven must lay on supports standing the oven weight.
- Remember the housing should not be free standing but be secured to the wall and/or adjacent fittings.
- We would point out that the adhesive which bonds the plastic laminate to the furniture must withstand temperatures not less than 150° C to avoid delamination.
- The walls of the units must be capable of resisting temperatures of 75 °C above room temperature.
- Do not seal the oven into the cabinetry with silicone or glue; this makes future servicing difficult. Delonghi will not cover the costs of removing the oven, or of damage caused by this removal.
- The walls surrounding the oven must be made of heat-resistant material.
- **WARNING:** Taking care NOT to lift the oven by the door handle.

WARNING

When correctly installed, your product meets all safety requirements laid down for this type of product category.

However special care should be taken around the rear or the underneath of the appliance as these areas are not designed or intended to be touched and may contain sharp or rough edges, that may cause injury.

IMPORTANT

Some environmental factors and cooking habits can cause condensation in and around the oven during use. To protect surrounding cabinetry from possible damage caused by frequent or excessive condensation, we recommend moisture-proofing the oven cavity.

Figure 1

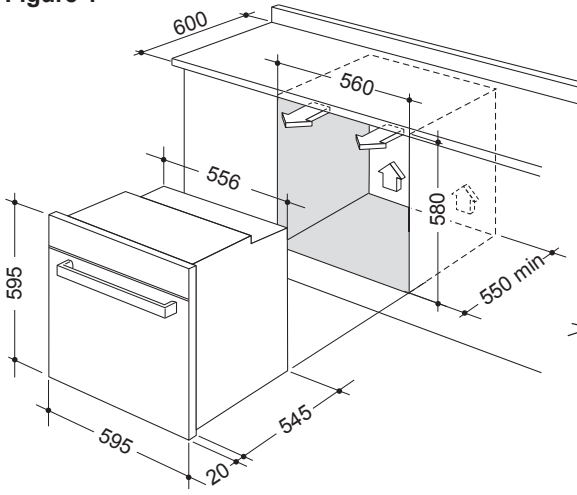
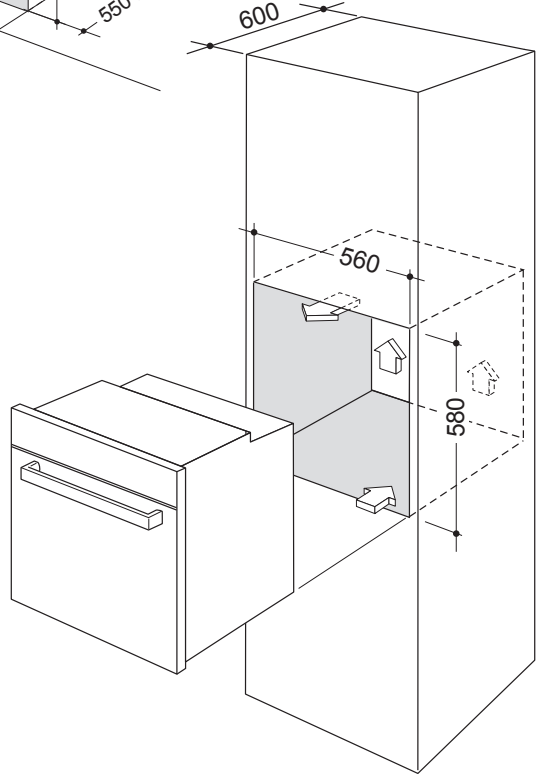

Figure 2



FIXING THE OVEN

Introduce the oven into the furniture opening and fix it with 2 screws (not supplied) as figure 3. Before fixing the 2 screws, fit the 2 plastic bushes (supplied with the appliance in a separate kit) into the fixing holes. Take care to fit the bushes in the correct way, they must lie flat.

It is essential that the oven rests on a surface which will support its weight, as the screw fixing is only complementary.

Note:

It is essential that when installing your oven adequate air circulation is allowed for within the installation. See figures 1, 2.

Inadequate air circulation may greatly impair the performance of your oven and may effect adjacent cabinets due to an increase in temperature.

Caution!

Do not lift this oven by the door handle.

Adjust the hinges of furniture doors adjacent to the oven to allow a 4-5 mm gap between the furniture door and the oven frame.

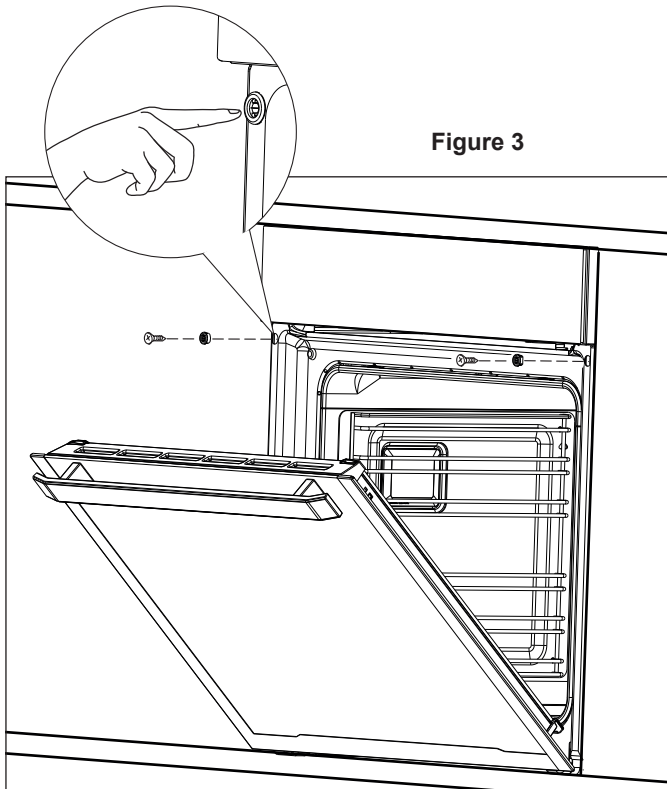

ELECTRICAL REQUIREMENTS

- The appliance must be connected to the mains checking that the voltage corresponds to the value given in the rating plate and that the electrical cable sections can withstand the load specified on the plate.
- A suitable isolating switch providing full disconnection from the mains power supply shall be incorporated in the permanent wiring, mounted and positioned to comply with the local wiring rules and regulations. The isolating switch must be of an approved type and provide a 3 mm air gap contact separation in all poles (or in all active [phase] conductors if the local wiring rules allow for this variation of the requirements).
- The isolating switch shall be easily accessible to the customer with the oven installed.
- If the electrical supply is restricted, means of all-pole disconnection must be accessible and incorporated in the fixed wiring in accordance with the wiring rules.
- The power supply cable must not touch the hot parts and must be positioned so that it does not exceed 75°C above ambient.
- The oven is supplied without a power supply plug and therefore if you are not connecting directly to the mains, a standardized plug suitable for the load must be fitted.
- The plug must be connected to an earthed socket in compliance with safety standards.
- To connect the appliance to the mains electricity supply, do not use adapters, reducers or branching devices as they can cause overheating and burning.
- Once the appliance has been installed, the switch or socket must always be accessible.
- If the supply cord is damaged it must be replaced by the manufacturer or it's Service Agent or a similarly qualified person in order to avoid a hazard.

N.B. The connection of the appliance to earth is mandatory.

If the installation requires alterations to the domestic electrical system call a qualified electrician. He should also check that the domestic electrical system is suitable for the power drawn by the appliance.

Replacing the power cord must be done by a qualified electrician in accordance with the instructions supplied by the manufacturer and in compliance with established electrical regulations.

REPLACING THE POWER SUPPLY CABLE

Important! This appliance must be connected to the electricity supply only by an authorised person.

To connect the supply cable:

- Unhook the terminal board cover by inserting a screwdriver into the two hooks “A” (fig. 4).
- Unscrew the screw “D” and open completely the cable clamp “E” (fig. 5).
- Connect the phase, neutral and earth wires to terminal board “G” according to the diagram in fig. 6.
- Strain the feeder cable and block it with cable clamp “E” (by screwing screw “D”).
- Close the terminal block cover (check the two hooks “A” are correctly hooked).

N.B. The earth conductor must be left about 3 cm longer than the others.

VOLTAGE AND POWER CONSUMPTION

Depending on model there are different values as per list here below (please refer to product rating plate to correctly identify the wattage of your oven)

220-240 V ac	2100 W (9.13 A)
220-240 V ac	2600 W (11.30 A)
220-240 V ac	2850 W (12.4 A)
220-240 V ac	3030 W (13.17 A)
220-240 V ac	3500 W (15.21 A)

FEEDER CABLE SECTION TYPE H05RR-F

3 x 1,5 mm² (*) (**)

(*) Connection possible with plug and outlet

(**) Connection with wall box connection.

Figure 4

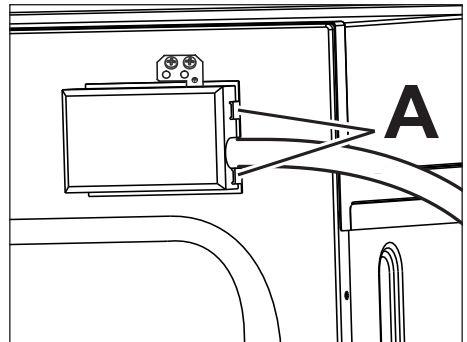

Figure 5

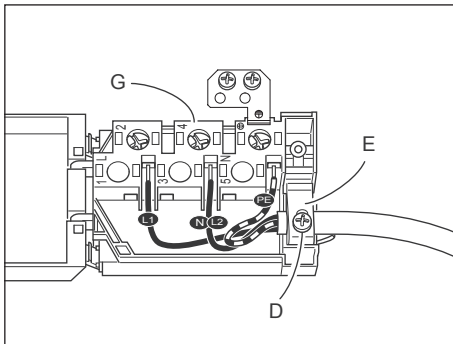
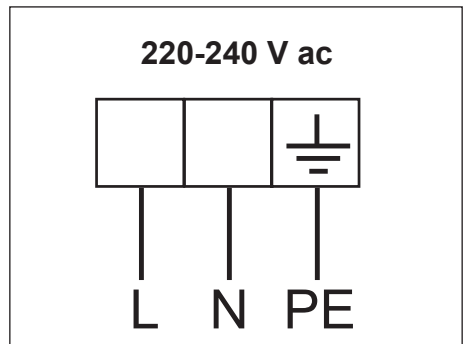
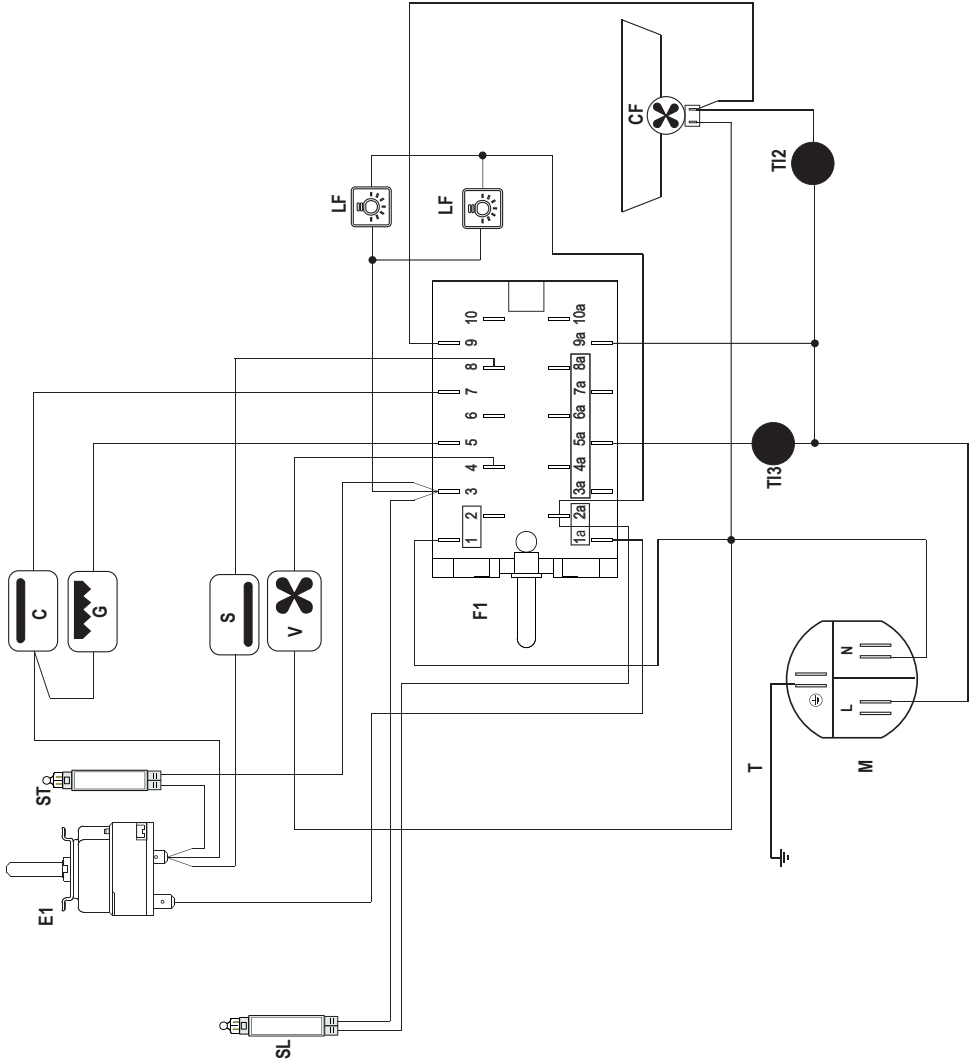

Figure 6



ELECTRIC DIAGRAM FOR SIMPLIFIED MULTIFUNCTION MODELS WITH 60' OR 120' ALARM

Figure 7



ELECTRIC DIAGRAM KEY

F1	Oven switch
E1	Oven thermostat
ST	Thermostat pilot lamp
SL	Line pilot lamp
LF	Oven lamps
C	Top element
G	Grill element
V	Fan
S	Bottom element
TL2	Thermal overload
CF	Cooling fan
TL3	Thermal overload
M	Terminal block
T	Earth connection

ELECTRIC DIAGRAM FOR MULTIFUNCTION MODELS WITH ELECTRONIC CLOCK/PROGRAMMER (START-END COOKING)

Figure 8

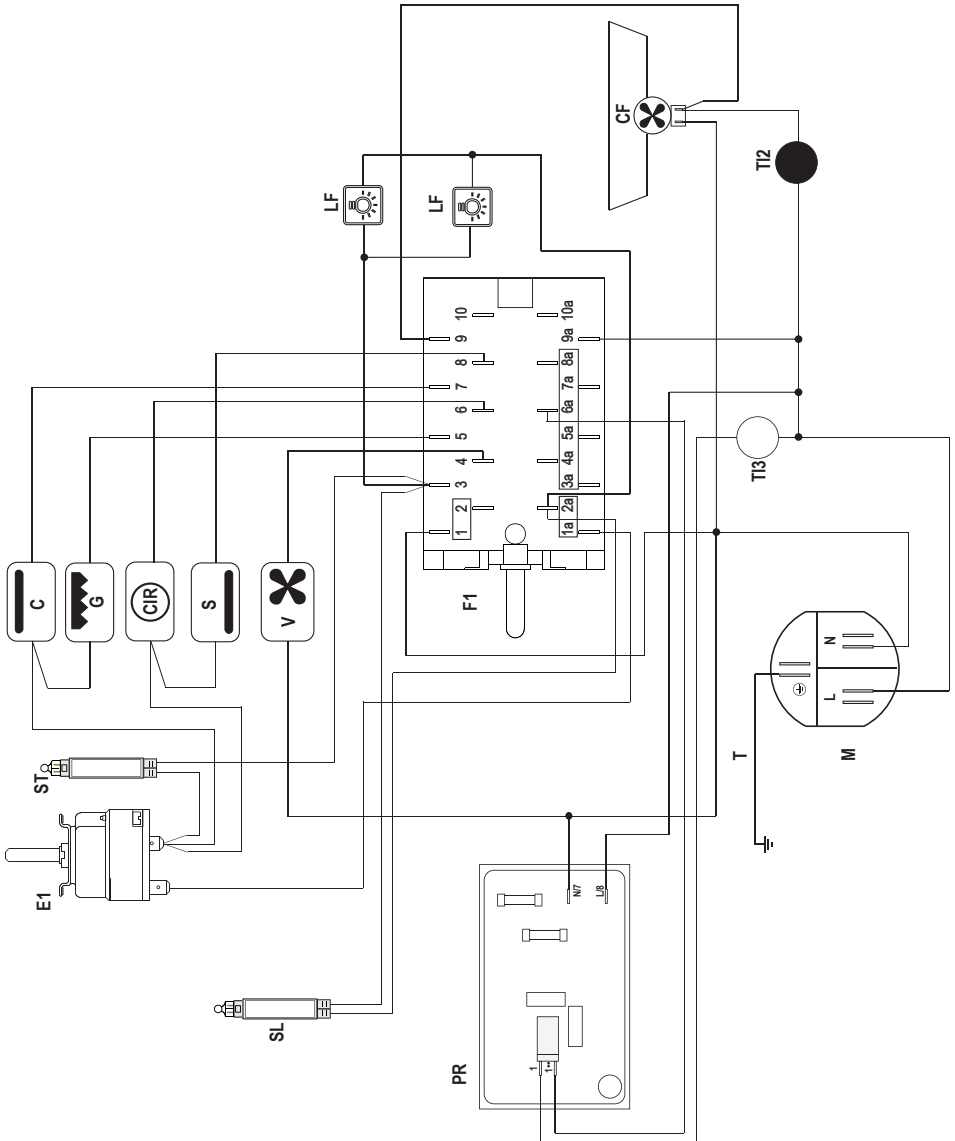

ELECTRIC DIAGRAM KEY

F1	Oven switch
E1	Oven thermostat
ST	Thermostat pilot lamp
SL	Line pilot lamp
PR	Oven programmer
LF	Oven lamps
C	Top element
G	Grill element
V	Fan
S	Bottom element
CIR	Circular element
TL2	Thermal overload
CF	Cooling fan
TL3	Thermal overload
M	Terminal block
T	Earth connection

USE AND CARE

CAUTION:

- This appliance must be used only for the task it has explicitly been designed for, that is for domestic cooking of foodstuffs. Any other form of usage is to be considered as inappropriate and therefore dangerous.
- Do NOT place combustible materials or products on this appliance at any time.

OVEN FITTING OUT

Fit the catalytic panel to the side rack (some models only)

- Ensure the panels are placed the correct way around (with the arrow up): the cutout fits over the light and the hole for the fixing screw goes to the front of the oven.
- Fit the rear prongs of the side rack through the holes in the catalytic panel.

Fit the side racks

- Slide the rear prongs of the side rack into the holes "A" at the rear of the oven (fig. 9a).
- Fit the side rack front tab over the fixing hole and tighten the fixing screw (fig. 9a).
- Slide in, on the guides, the shelf (fig. 9b). The shelf must be fitted so that the safety notch, which stops it sliding out, faces the inside of the oven; the guard rail shall be at the back.
- To dismantle, operate in reverse order.

Oven tray

- The oven tray must be correctly placed on the shaped wire shelf (not the flat one) or on the telescopic sliding shelf supports (fig. 9b, with the sliding supports not on the third level from the bottom).

Figure 9a

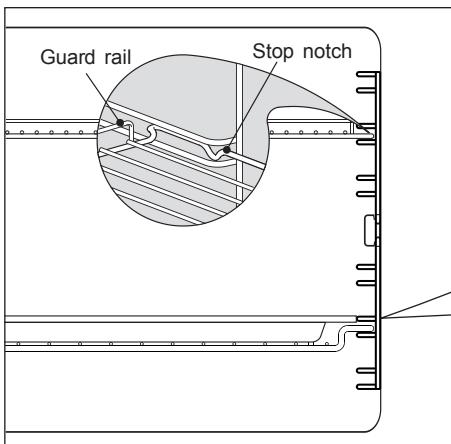
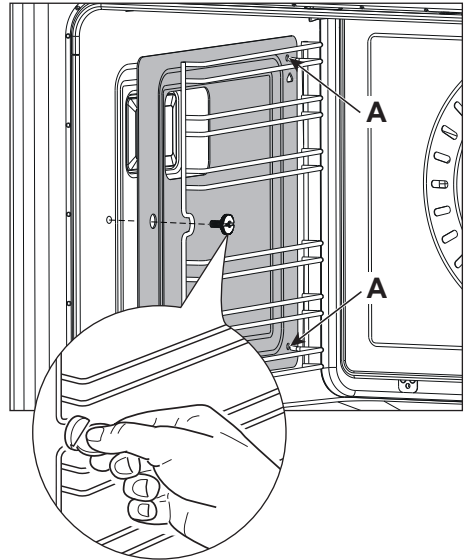
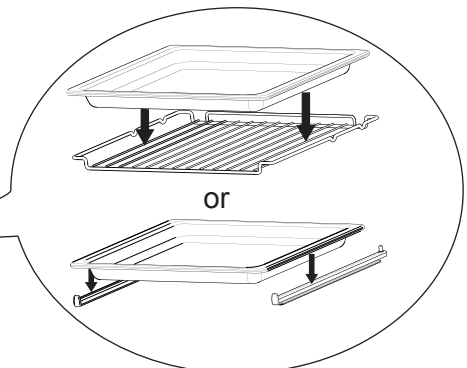

Figure 9b



ADVICE FOR USE AND MAINTENANCE OF CATALYTIC PANELS (SUPPLIED WITH SOME MODELS ONLY)

The catalytic panels are covered with special microporous enamel which absorbs and does away with oil and fat splashes during normal baking over 200°C.

If, after cooking very fatty foods, the panels remain dirty, operate the oven "idling" on max temperature for about 30 minutes.

These panels do not require to be cleaned, however it is advised to periodically remove them from the oven (at least the side panels) and to wash them with tepid soapy water and then wipe off with a soft cloth.

DO NOT CLEAN OR WASH THEM WITH ABRASIVE PRODUCTS OR WITH PRODUCTS CONTAINING ACIDS OR ALKALIS.

The side panels are reversible and when the catalytic microporous enamel degrades, they can be turned to the other side.

GREASE FILTER (SOME MODELS ONLY)

- A special screen is provided at the back of the oven to catch grease particles, mainly when meat is being roasted (fig. 10).
- Clean the filter after any cooking! The grease filter can be removed for cleaning and should be washed regularly in hot soapy water (fig. 10).
- Always dry the filter properly before fitting it back into the oven.

CAUTION: When baking pastry etc. this filter should be removed.

Figure 10

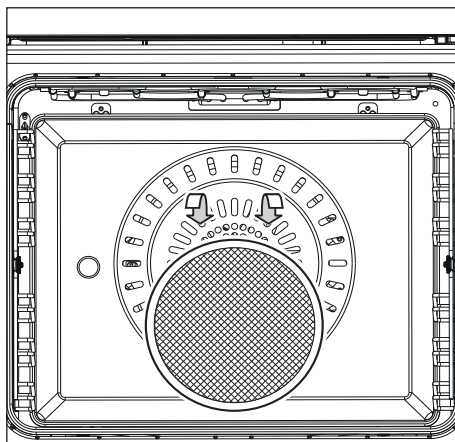

TELESCOPIC SLIDING SHELF SUPPORTS (SOME MODELS ONLY)

The telescopic sliding shelf supports make it safer and easier to insert and remove the oven shelf and tray. They stop when they are pulled out to the maximum position.

Important! When fitting the sliding shelf supports, make sure that you fit:

- The slides to the top wire of a rack. They do not fit on the lower wire.
- The slides so that they run out towards the oven door.
- Both sides of each pair of shelf slides.
- Both sides on the same level.

To fix the sliding shelf support onto the side racks:

- Screw the side racks onto the oven walls (fig. 9a).
- Fit the sliding shelf support onto the top wire of a rack and press (fig. 11). You will hear a click as the safety locks clip over the wire.

To remove the telescopic sliding shelf supports:

- Remove the side racks by unscrewing the fixing screws (fig. 12).
- Lay down the telescopic sliding shelf support and side racks, with the telescopic sliding shelf support underneath.
- Find the safety locks. These are the tabs that clip over the wire of the side rack (arrow 1 in fig. 13).
- Pull the safety locks away from the wire to release the wire (arrow 2 in fig. 13).

Cleaning the sliding shelf supports:

- Wipe the supports with a damp cloth and a mild detergent only.
- Do not wash them in the dishwasher, immerse in soapy water, or use oven cleaner on them.

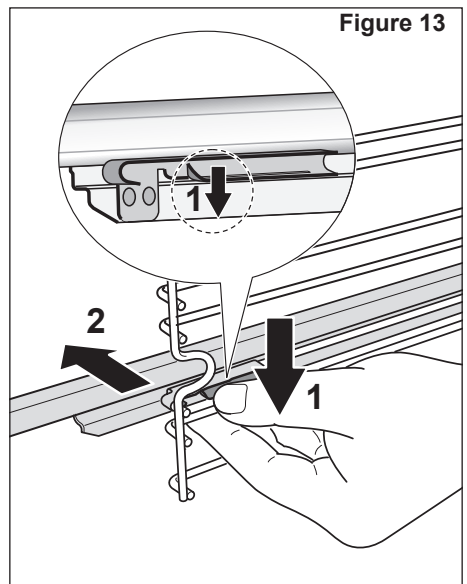
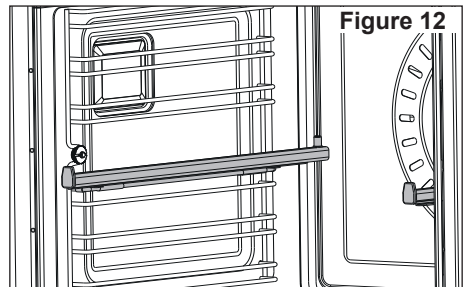
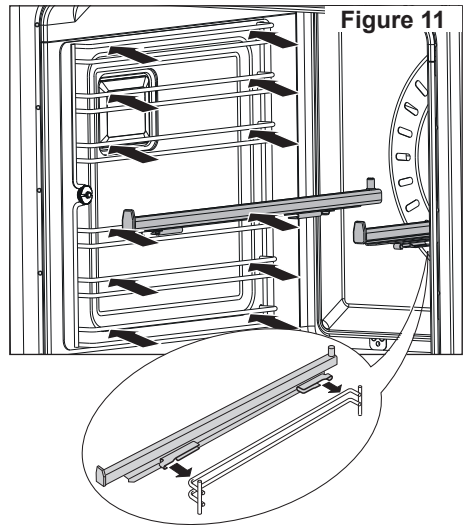

CONTROL PANELS

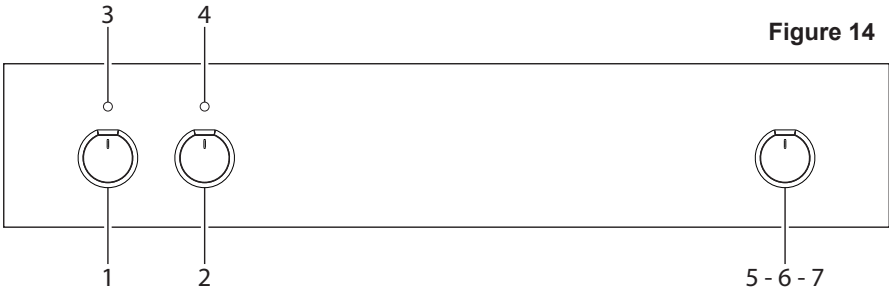

Figure 14

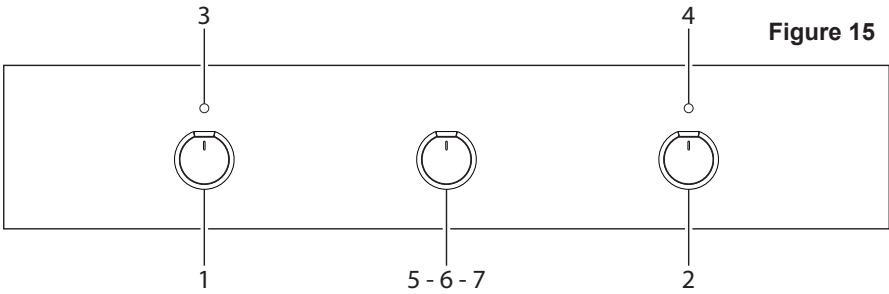

Figure 15

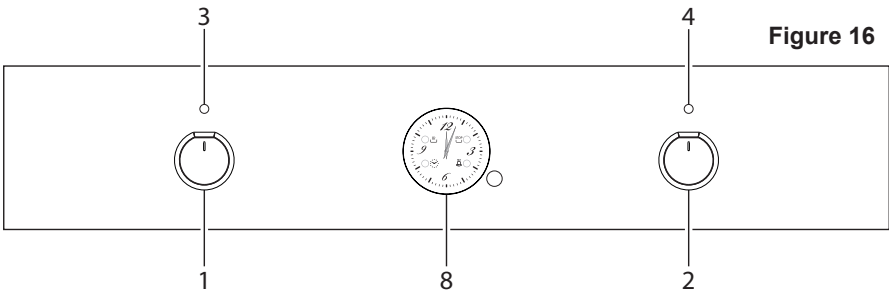

Figure 16

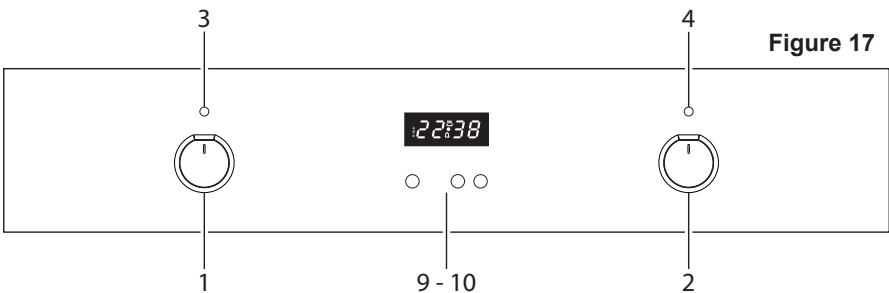

Figure 17

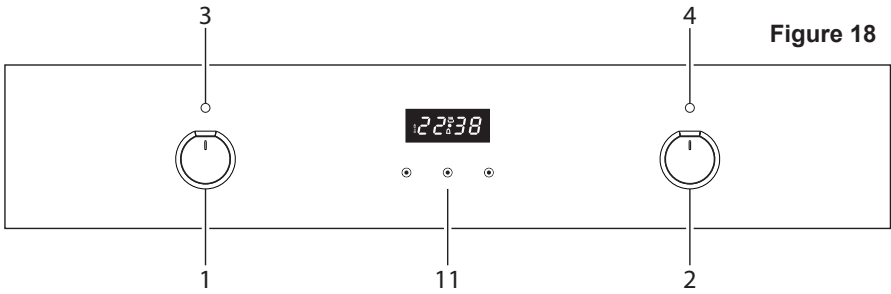

Figure 18

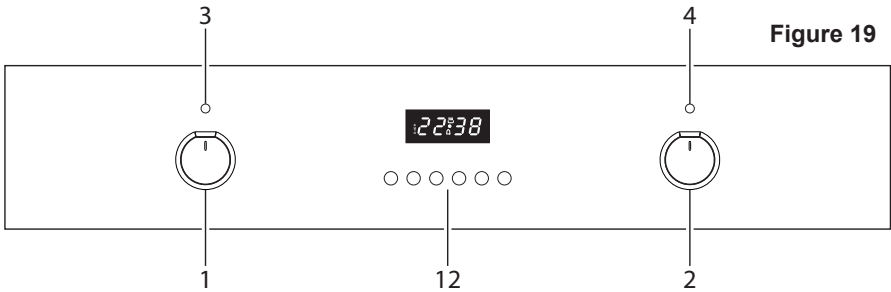

Figure 19

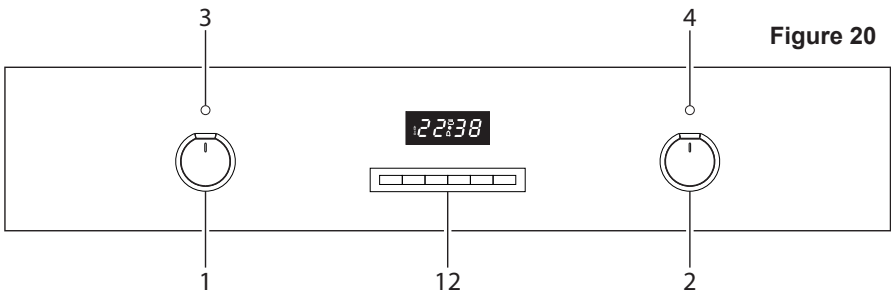

Figure 20

CONTROLS DESCRIPTION

1. Function selector control knob
2. Oven temperature control knob
3. Power on indicator light
4. Oven temperature indicator light
5. 60 minutes alarm
6. 120 minutes alarm
7. Timer (120 minutes cut-off)
8. Electric clock/programmer (start-end cooking)
9. Electronic clock with alarm
10. Electronic clock/end cooking timer
11. Clock and timer with "Touch-Control" keys
12. Electronic clock/programmer (start-end cooking)

Please note:

This appliance incorporates a safety cooling fan which you will hear operating whenever the oven or grill are in use. This fan may continue to run for several minutes after the appliance has been switched off.

This fan is to reduce the external temperature of the appliance and cool the internal components.

USING THE PRESS-AND-TURN CONTROL KNOBS (SOME MODELS ONLY)

The control knobs are flush-mounted in the control panel.

Use them as follows:

- Press lightly on the knob (figure 21);
- The knob will extend outwards as illustrated in figure 22.
- Turn the knob to the required position (figure 23).
- When you have finished cooking, turn the knob back to the “0”, “O” or “□” (off) position and press it (figure 24) so that it stays flush with the control panel again (figure 26).

IMPORTANT:

Never press down the knob when it is not in the “0”, “O” or “□” (off) position (figure 25).

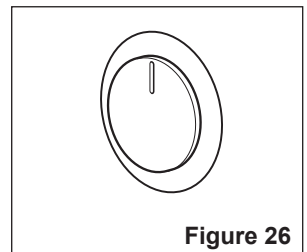
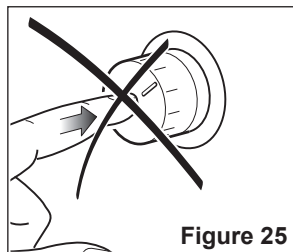
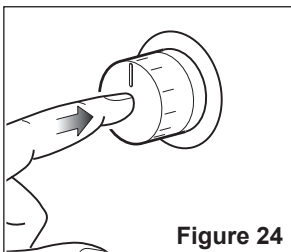
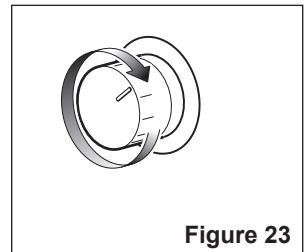
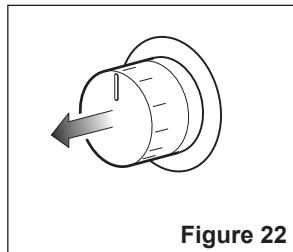
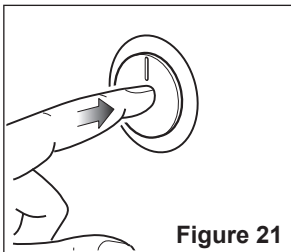

OVEN VERSIONS

NATURAL CONVECTION MODELS

TYPE 1 (WITHOUT ROTISSERIE)

Function
selector
knob

Figure 27

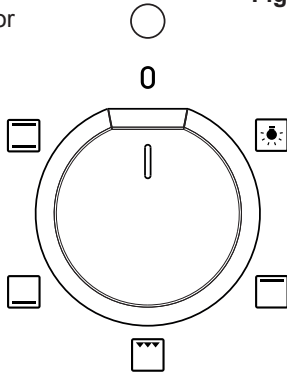

NOTES: The knob and symbols may vary. The symbols may be printed on the knob itself.

TYPE 2 (WITH ROTISSERIE)

Function
selector
knob

Figure 28

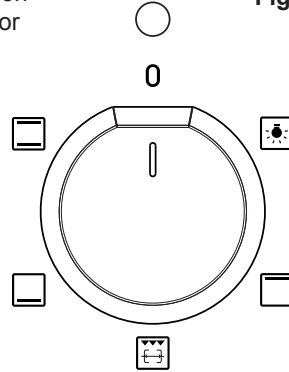

NOTES: The knob and symbols may vary. The symbols may be printed on the knob itself.

GENERAL FEATURES

This oven features no.4 (figs. 27, 28) different thermostatic control functions to satisfy all cooking requirements, provided by 3 heating elements:

- upper element;
- lower element;
- grill element.

NOTE:

Upon first use, it is advisable to operate the oven at the maximum temperature for 60 minutes in the position  to eliminate possible traces of grease on the heating elements.

Repeat the operation for another 20 minutes with the grill element on as explained in the chapters “TRADITIONAL GRILLING” and “USE OF THE GRILL”.

OPERATING PRINCIPLES

Heating and cooking in the natural convection oven are obtained in the following ways:

- by normal convection**
The heat is produced by the upper and lower heating elements.
- by radiation**
The heat is radiated by the infrared grill element.

FAN WITH GRILL MODELS

TYPE 1 (WITHOUT ROTISSERIE)

Function selector knob

Figure 29

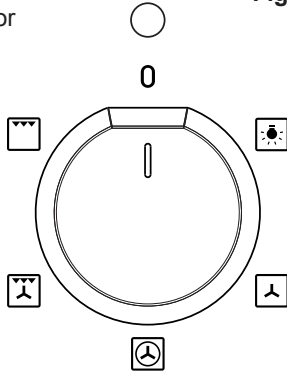

NOTES: The knob and symbols may vary. The symbols may be printed on the knob itself.

TYPE 2 (WITH ROTISSERIE)

Function selector knob

Figure 30

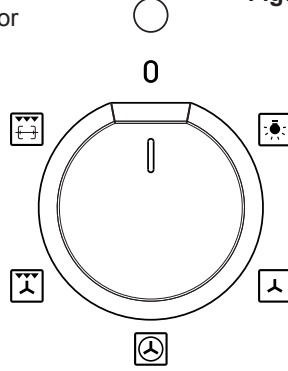

NOTES: The knob and symbols may vary. The symbols may be printed on the knob itself.

GENERAL FEATURES

The heating and cooking in electrical hot air ovens take place by forced convection.

The two elements which make this process take place are:

- circular element;
- grill element.

NOTE:

Upon first use, it is advisable to operate the oven at the maximum temperature for 60 minutes in the position  to eliminate possible traces of grease on the heating elements.

Repeat the operation for another 20 minutes with the grill element on as explained in the chapters "TRADITIONAL GRILLING" and "USE OF THE GRILL".

OPERATING PRINCIPLES

Heating and cooking in the fan oven are obtained in the following ways:

- by forced convection**
A fan sucks in the air contained in the oven, which circulates it through the circular heating element and then forced back into the oven by the fan. Before the hot air is sucked back again by the fan to repeat the described cycle, it envelops the food in the oven, provoking a complete and rapid cooking. It is possible to cook several dishes simultaneously.
- by radiation**
The heat is radiated by the infrared grill element.
- by radiation and ventilation**
The radiated heat from the infrared grill element is distributed throughout the oven by the fan.
- by ventilation**
The food is defrosted by using the fan only function without heat.

SIMPLIFIED MULTIFUNCTION MODELS

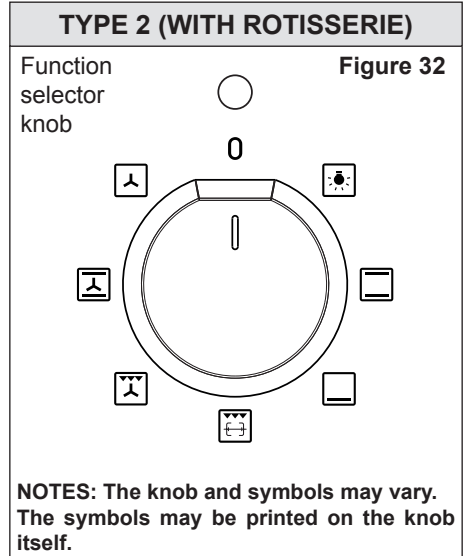
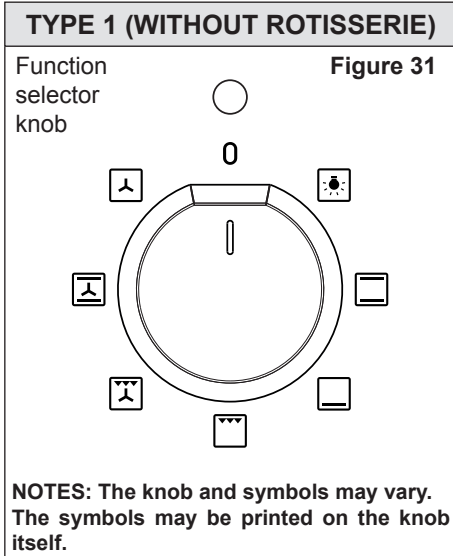

GENERAL FEATURES

As its name indicates, this is an oven that presents particular features from an operational point of view.

In fact, it is possible to insert no.6 (figs. 31, 32) different programs to satisfy every cooking need.

The 6 positions, thermostatically controlled, are obtained by 3 heating elements which are:

- Upper element;
- Lower element;
- Grill element.

NOTE:

Upon first use, it is advisable to operate the oven at the maximum temperature for 60 minutes in the position to eliminate possible traces of grease on the heating elements.

Repeat the operation for another 20 minutes with the grill element on as explained in the chapters "TRADITIONAL GRILLING" and "USE OF THE GRILL".

OPERATING PRINCIPLES

Heating and cooking in the plurifunction oven are obtained in the following ways:

- a. **by normal convection**
The heat is produced by the upper and lower heating elements.
- b. **by semi-forced convection**
The heat produced by the upper and lower heating elements is distributed throughout the oven by the fan.
- c. **by radiation**
The heat is radiated by the infrared grill element.
- d. **by radiation and ventilation**
The radiated heat from the infrared grill element is distributed throughout the oven by the fan.
- e. **by ventilation**
The food is defrosted by using the fan only function without heat.

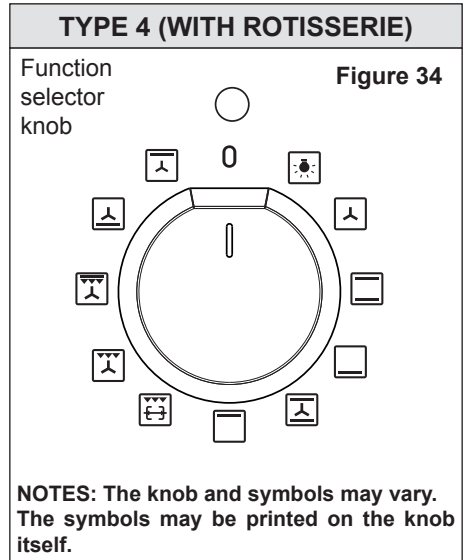
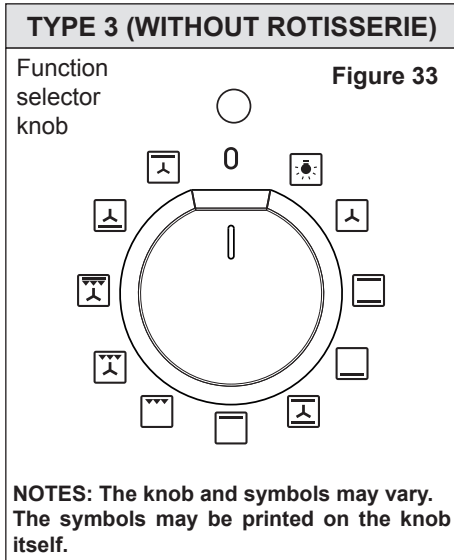

GENERAL FEATURES

As its name indicates, this is an oven that presents particular features from an operational point of view.

In fact, it is possible to insert no.10 (figs. 33, 34) different programs to satisfy every cooking need.

The 10 positions, thermostatically controlled, are obtained by 3 heating elements which are:

- Upper element;
- Lower element;
- Grill element.

NOTE:

Upon first use, it is advisable to operate the oven at the maximum temperature for 60 minutes in the position  to eliminate possible traces of grease on the heating elements.

Repeat the operation for another 20 minutes with the grill element on as explained in the chapters "TRADITIONAL GRILLING" and "USE OF THE GRILL".

OPERATING PRINCIPLES

Heating and cooking in the plurifunction oven are obtained in the following ways:

- a. **by normal convection**
The heat is produced by the upper and lower heating elements.
- b. **by semi-forced convection**
The heat produced by the upper and lower heating elements is distributed throughout the oven by the fan.
- c. **by radiation**
The heat is radiated by the infrared grill element.
- d. **by radiation and ventilation**
The radiated heat from the infrared grill element is distributed throughout the oven by the fan.
- e. **by ventilation**
The food is defrosted by using the fan only function without heat.

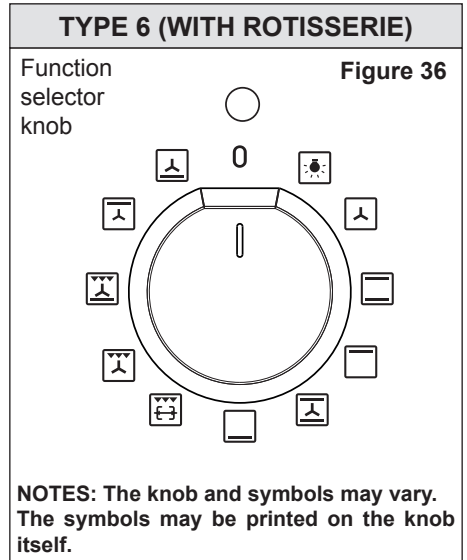
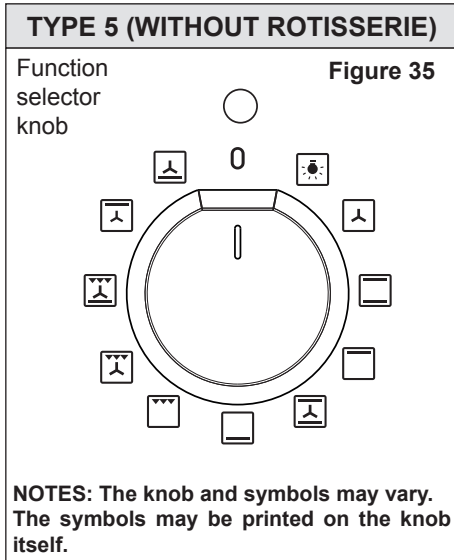

GENERAL FEATURES

As its name indicates, this is an oven that presents particular features from an operational point of view.

In fact, it is possible to insert no.10 (figs. 35, 36) different programs to satisfy every cooking need.

The 10 positions, thermostatically controlled, are obtained by 3 heating elements which are:

- Upper element;
- Lower element;
- Grill element.

NOTE:

Upon first use, it is advisable to operate the oven at the maximum temperature for 60 minutes in the position  to eliminate possible traces of grease on the heating elements.

Repeat the operation for another 20 minutes with the grill element on as explained in the chapters "TRADITIONAL GRILLING" and "USE OF THE GRILL".

OPERATING PRINCIPLES

Heating and cooking in the plurifunction oven are obtained in the following ways:

- a. **by normal convection**
The heat is produced by the upper and lower heating elements.
- b. **by semi-forced convection**
The heat produced by the upper and lower heating elements is distributed throughout the oven by the fan.
- c. **by radiation**
The heat is radiated by the infrared grill element.
- d. **by radiation and ventilation**
The radiated heat from the infrared grill element is distributed throughout the oven by the fan.
- e. **by ventilation**
The food is defrosted by using the fan only function without heat.

MULTIFUNCTION MODELS

TYPE 1 (WITHOUT ROTISSERIE)

Function selector knob

Figure 37

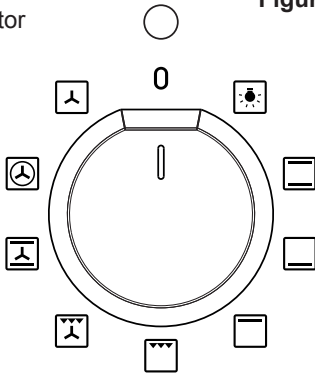

NOTES: The knob and symbols may vary. The symbols may be printed on the knob itself.

TYPE 2 (WITH ROTISSERIE)

Function selector knob

Figure 38

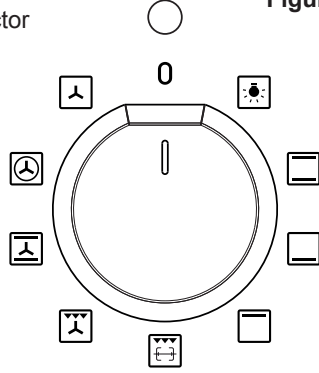

NOTES: The knob and symbols may vary. The symbols may be printed on the knob itself.

GENERAL FEATURES



As its name indicates, this is an oven that presents particular features from an operational point of view.

In fact, it is possible to insert no.8 (figs. 37, 38) different programs to satisfy every cooking need.

The 8 positions, thermostatically controlled, are obtained by 4 heating elements which are:

- upper element;
- lower element;
- grill element;
- circular element.

NOTE:

Upon first use, it is advisable to operate the oven at the maximum temperature for 60 minutes in the position  and  to eliminate possible traces of grease on the heating elements.

Repeat the operation for another 20 minutes with the grill element on as explained in the chapters "TRADITIONAL GRILLING" and "USE OF THE GRILL".

OPERATING PRINCIPLES

Heating and cooking in the multifunction oven are obtained in the following ways:

- by normal convection**
The heat is produced by the upper and lower heating elements.
- by forced convection**
A fan sucks in the air contained in the oven, which circulates it through the circular heating element and then forced back into the oven by the fan.
Before the hot air is sucked back again by the fan to repeat the described cycle, it envelops the food in the oven, provoking a complete and rapid cooking. It is possible to cook several dishes simultaneously.
- by semi-forced convection**
The heat produced by the upper and lower heating elements is distributed throughout the oven by the fan.
- by radiation**
The heat is radiated by the infrared grill element.
- by radiation and ventilation**
The radiated heat from the infrared grill element is distributed throughout the oven by the fan.
- by ventilation**
The food is defrosted by using the fan only function without heat.

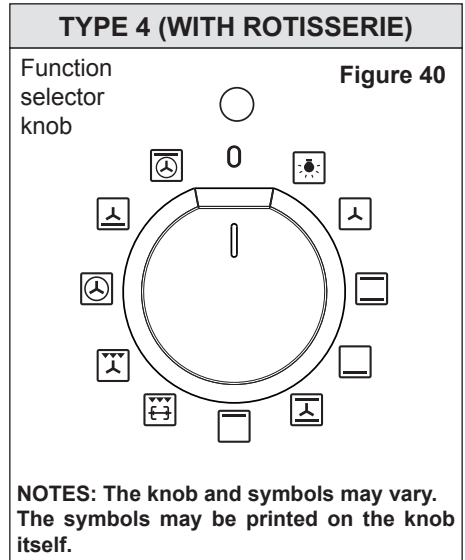
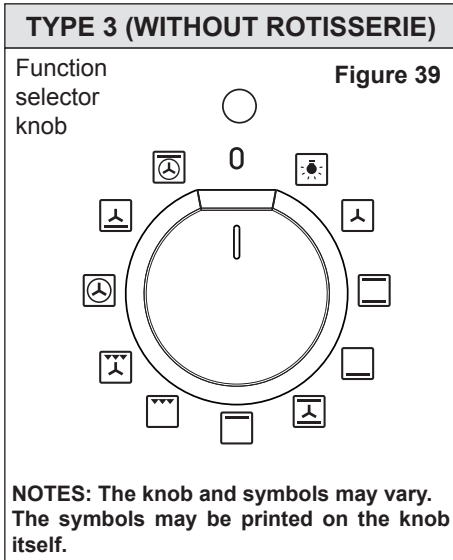

GENERAL FEATURES



As its name indicates, this is an oven that presents particular features from an operational point of view.

In fact, it is possible to insert no.10 (figs. 39, 40) different programs to satisfy every cooking need.

The 10 positions, thermostatically controlled, are obtained by 4 heating elements which are:

- upper element;
- lower element;
- grill element;
- circular element.

NOTE:

Upon first use, it is advisable to operate the oven at the maximum temperature for 60 minutes in the position  and  to eliminate possible traces of grease on the heating elements.

Repeat the operation for another 20 minutes with the grill element on as explained in the chapters "TRADITIONAL GRILLING" and "USE OF THE GRILL".

OPERATING PRINCIPLES

Heating and cooking in the multifunction oven are obtained in the following ways:

- a. **by normal convection**
The heat is produced by the upper and lower heating elements.
- b. **by forced convection**
A fan sucks in the air contained in the oven, which circulates it through the circular heating element and then forced back into the oven by the fan.
Before the hot air is sucked back again by the fan to repeat the described cycle, it envelops the food in the oven, provoking a complete and rapid cooking. It is possible to cook several dishes simultaneously.
- c. **by semi-forced convection**
The heat produced by the upper and lower heating elements is distributed throughout the oven by the fan.
- d. **by radiation**
The heat is radiated by the infrared grill element.
- e. **by radiation and ventilation**
The radiated heat from the infrared grill element is distributed throughout the oven by the fan.
- f. **by ventilation**
The food is defrosted by using the fan only function without heat.

HOW TO USE THE OVEN

ATTENTION:

The oven door becomes very hot during operation.

Keep children away.

WARNING:

The door is hot, use the handle.

WARNING:

During use the appliance becomes hot. Care should be taken to avoid touching heating elements inside the oven.

THERMOSTAT CONTROL KNOB

(figs. 41 - 42)

To turn on the heating elements of the oven, set function selector knob to the required position and the thermostat knob to the desired temperature.









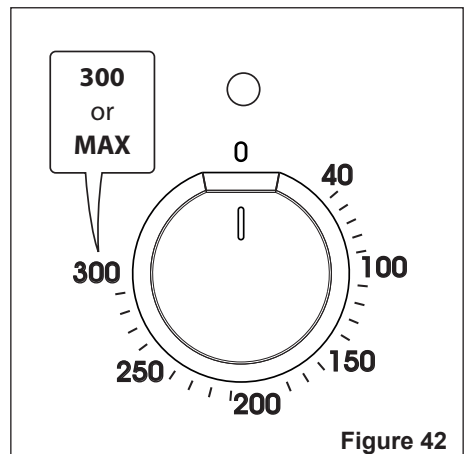
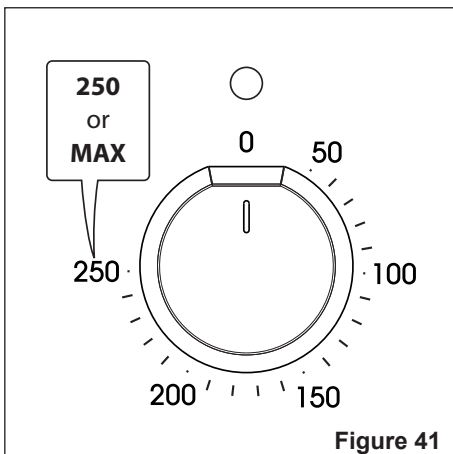























The elements will turn on or off automatically which is determined by the thermostat. The operation of the heating elements is signalled by a light placed on the control panel.

FUNCTION SELECTOR CONTROL KNOB

(fig. 27, 28, ..., 39, 40)

Rotate the knob clockwise to set the oven to one of the following functions:



Oven functions	
	Natural convection models Type 1 (without rotisserie)
	Natural convection models Type 2 (with rotisserie)
	Fan with grill models Type 1 (without rotisserie)
	Fan with grill models Type 2 (with rotisserie)
	Plurifunction models Type 1 (without rotisserie)
	Plurifunction models Type 2 (with rotisserie)
	Plurifunction models Type 3 (without rotisserie)
	Plurifunction models Type 4 (with rotisserie)
	Plurifunction models Type 5 (without rotisserie)
	Plurifunction models Type 6 (with rotisserie)
	Multifunction models Type 1 (without rotisserie)
	Multifunction models Type 2 (with rotisserie)
	Multifunction models Type 3 (without rotisserie)
	Multifunction models Type 4 (with rotisserie)
	
	
	
	
	
	
	
	
	
	
	
	
	
	
	
	
	
	

(1) Function  without using the rotisserie.

NOTE: DEPENDING ON YOUR MODEL, YOUR OVEN MAY ONLY HAVE SOME OF THESE FUNCTIONS (SEE CHAPTER 2 AND TABLE AT PAGE NO. 18).



OVEN LIGHT

By turning the function selector knob to this setting, the oven light/s will illuminate in the oven cavity.

The oven light/s will operate on all selected functions.



TRADITIONAL CONVECTION COOKING

The upper and lower heating elements are switched on.

The heat is diffused by natural convection and the temperature must be regulated between 40/50°C and the maximum position with the thermostat knob.

It is necessary to preheat the oven before introducing the foods to be cooked.

Recommended for:

For foods which require the same cooking temperature both internally and externally, i. e. roasts, spare ribs, meringue, etc.



LOWER HEATING ELEMENT

In this position only the lower heating element is switched on.

Heat is distributed by natural convection. The temperature must be regulated between 40/50°C and **100°C maximum**.

Recommended for:

To complete cooking of dishes that require higher temperature at the bottom.



UPPER HEATING ELEMENT

In this position only the upper heating element is switched on.

Heat is distributed by natural convection. The temperature must be regulated between 40/50°C and the maximum position with the thermostat knob.

Recommended for:

To complete cooking of dishes that require higher temperature at the top.



TRADITIONAL GRILLING

The infrared heating element is switched on. The heat is diffused by radiation.

Use with the oven door closed and the thermostat knob must be regulated between 40/50°C and **250°C maximum**.

For correct use see chapter "USE OF THE GRILL".

Some models only: In the  position the rotisserie motor come on for cooking with the rotisserie. For correct use see chapters "USE OF THE GRILL" and "USE OF THE ROTISSERIE".

Recommended for:

Intense grilling action for cooking with the broiler; browning, crisping, "au gratin", toasting, etc.



VENTILATED GRILL COOKING

The infrared heating element and the fan motor are switched on.

The heat is mainly diffused by radiation and the fan then distributes it throughout the oven.

Use with the oven door closed and the thermostat knob must be regulated between 40/50°C and **250°C maximum**.

It is necessary to preheat the oven for about 5 minutes.

For correct use see chapter "GRILLING AND AU GRATIN".

Recommended for:

For grill cooking when a fast outside browning is necessary to keep the juices in, i. e. veal steak, steak, hamburger, etc.



CONVECTION COOKING WITH VENTILATION

The upper and lower heating elements and the fan motor are switched on.

The heat coming from the top and bottom is diffused by forced convection.

The temperature must be regulated between 40/50°C and the maximum position with the thermostat knob.

Recommended for:

For foods of large volume and quantity which require the same internal and external degree of cooking; for ex: rolled roasts, turkey, legs, cakes, etc.



HOT AIR COOKING

The circular heating element and the fan motor are switched on.

The heat is diffused by forced convection and the temperature must be regulated between 40/50°C and the maximum position with the thermostat knob.

It is not necessary to preheat the oven.

Recommended for:

For foods that must be well done on the outside and tender or rare on the inside, i. e. lasagna, lamb, roast beef, whole fish, etc.



DEFROSTING FROZEN FOODS

Only the oven fan is switched on.

To be used with the thermostat knob in the "0", "●" or "■" (off) position because the other positions have no effect.

The defrosting is done by simple ventilation without heat.

Recommended for:

To rapidly defrost frozen foods; 1 kilogram requires about one hour.

The defrosting times vary according to the quantity and type of foods to be defrosted.



LOWER HEATING ELEMENT WITH VENTILATION

The lower heating element and the fan motor are switched on.

The heat coming from the bottom is diffused by forced convection.

The temperature must be regulated between 40/50°C and **100°C maximum** with the thermostat knob.

Recommended for:

To complete cooking of dishes that require higher temperature at the bottom.



UPPER HEATING ELEMENT WITH VENTILATION

The upper heating element and the fan motor are switched on.

The heat coming from the top is diffused by forced convection.

The temperature must be regulated between 40/50°C and the maximum position with the thermostat knob.

Recommended for:

To keep foods hot after cooking.

To slowly heat already cooked foods.



BOOSTER

This special function allows a fast pre-heating of the cavity by a combination of the heating elements (the radiant grill, the lower element and the fan motor or the radiant grill, the upper element and the fan motor or the upper element, the fan element and the fan motor).

Set the thermostat knob to the desired temperature; when the pre-heating temperature has been reached, the oven temperature indicator light, placed on the control panel, switches off.



VERY IMPORTANT NOTE: This special function must be operated without food inside the oven cavity.

COOKING ADVICE

NOTE: DEPENDING ON YOUR MODEL, YOUR OVEN MAY ONLY HAVE SOME OF THESE FUNCTIONS (SEE CHAPTER AND TABLE AT PAGE NO. 28).



STERILIZATION

Sterilization of foods to be conserved, in full and hermetically sealed jars, is done in the following way:

- Set the switch to position  or .
- Set the thermostat knob to position 185°C and preheat the oven.
- Fill the grill pan with hot water.
- Set the jars into the grill pan making sure they do not touch each other and the door and set the thermostat knob to position 135°C.

When sterilization has begun, that is, when the contents of the jars start to bubble, turn off the oven and let cool.

COOKING DIFFERENT DISHES AT THE SAME TIME

With the function selector in position  or , the ventilated oven allows you to cook different types of food at the same time.

Fish, cakes and meat can be cooked together without the smells and flavours mixing.

The only precautions required are the following:

- The cooking temperatures must be as close as possible with a maximum difference of 20 - 25°C between the different foods.
- Different dishes must be placed in the oven at different times according to the cooking time required for each one. This type of cooking obviously provides a considerable saving on time and energy.

REGENERATION

Set the switch to position  and the thermostat knob to position 150°C.

Bread becomes fragrant again if wet with a few drops of water and put into the oven for about 10 minutes.

ROASTING

To obtain classical roasting, it is necessary to remember:

- that it is advisable to maintain a temperature between 180 and 200°C.
- that the cooking time depends on the quantity and the type of foods.

USE OF THE GRILL

Leave to warm up for approximately 5 minutes with the door **closed**.

Place the food inside positioning the rack as near as possible to the grill.

Insert the drip pan under the rack to collect the cooking juices.

GRILLING AND “AU GRATIN”

Grilling may be done by selecting grill+fan setting  with the function selector knob, because the hot air completely envelops the food that is to be cooked.

Set the thermostat knob and after having preheated the oven, simply place the food on the grid.

Close the door and let the oven operate until grilling is done.

Adding a few dabs of butter before the end of the cooking time gives the golden “au gratin” effect.

Always grill with the oven door closed.

It is recommended that you do not grill for longer than 30 minutes at anyone time.

Attention: The oven door becomes very hot during operation. Keep children away.

The external parts of the oven become hot during operation. Keep children well out of reach.

USE OF THE ROTISSERIE (MODELS WITH ROTISSERIE ONLY)

The oven is equipped with a rotisserie for cooking on the spit using the grill.

This device is made up of:

- an electrical motor mounted on the rear part of the oven;
- a stainless steel rod, equipped with a detachable athermic grip and 2 recordable forks;
- a rod support to be inserted into the central guides of the oven cavity.

MODELS WITH ROTISSERIE

(fig. 43)

- Insert the tray into the lowest rack holders of the oven and insert the rod support into the intermediate rack holders.
- Put the meat to be cooked onto the rod, being careful to secure it in the center with the special forks.
- Insert the rod into the motor opening and rest it onto the support of the spit collar; then remove the grip by turning it to the left.
- Close the oven door and switch on the turnspit.
The rotation direction of the rotisserie can be either clockwise or counter-clockwise.

Very important: The rotisserie must always be used with the oven door closed.

Attention: The oven door becomes very hot during operation. Keep children away.

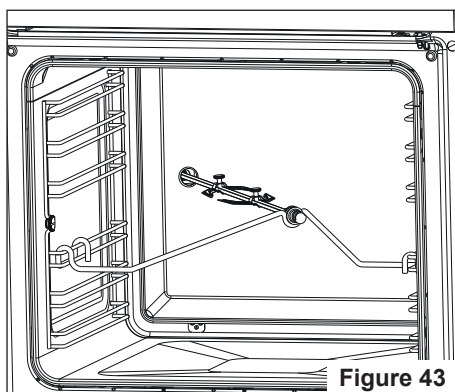

Figure 43

60' or 120' ALARM – 120' CUT-OFF TIMER

MODELS WITH 60 MINUTES ALARM

(fig. 44)

The minute counter is a timed acoustic warning device which can be set for a maximum of 60 minutes.

The knob must be rotated clockwise as far as the 60 minute position and then set to the required time by rotating it anticlockwise.

IMPORTANT WARNING: This is only a mechanical timer.

Remember to turn off the oven/grill manually.

Figure 44

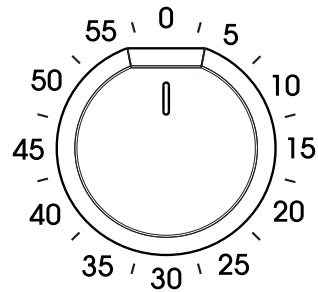

NOTES: The knob and symbols may vary. The symbols may be printed on the knob itself.

MODELS WITH 120 MINUTES ALARM

(fig. 45)

The minute counter is a timed acoustic warning device which can be set for a maximum of 120 minutes.

The knob must be rotated clockwise as far as the 120 minute position and then set to the required time by rotating it anticlockwise.

IMPORTANT WARNING: This is only a mechanical timer.

Remember to turn off the oven/grill manually.

Figure 45

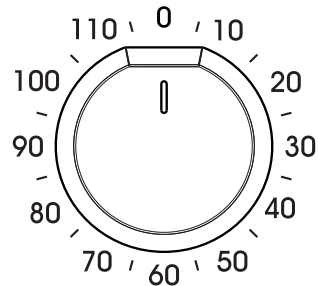

NOTES: The knob and symbols may vary. The symbols may be printed on the knob itself.

MODELS WITH 120 MINUTES CUT-OFF TIMER (fig. 46)

The function of the timer runs the oven for a preset time.

1) Starting up.

After setting the function selector and thermostat to the required mode and temperature, rotate the timer knob clockwise until you reach the required cooking time (max 120 minutes).

Once this time has elapsed, the timer will return to the “0”, “O” or “□” (off) position and the oven will automatically switch off.

2) Manual position.

If the cooking time is longer than two hours or if you wish to use the oven manually, switching it off as required, the knob must be turned to position .

Figure 46



NOTES: The knob and symbols may vary. The symbols may be printed on the knob itself.

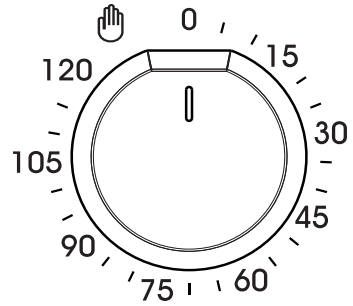
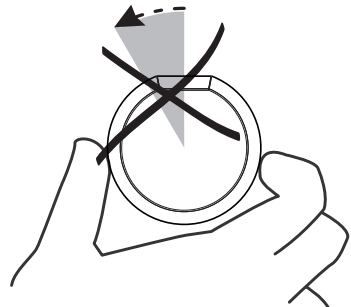
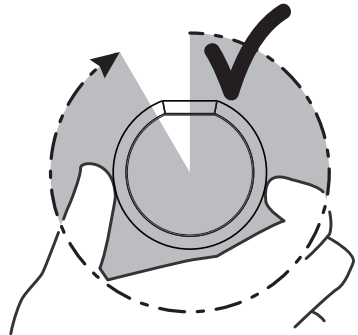

ELECTRIC CLOCK/PROGRAMMER (START-END COOKING)

MODELS WITH ELECTRIC CLOCK/PROGRAMMER (START-END COOKING) (fig. 47)

The electric clock/programmer is a device which groups the following functions:

- 12-hour analog clock;
- minute minder (max 3 hours);
- automatic cooking (* see note below);
- acoustic signal (beep) which is activated each time the “setting knob” is pressed or at the end of the minute minder function or automatic cooking program.

(*) The maximum programmable time (MPT) depends from the set start cooking time.

MPT = 15 hours - difference of hours between the set start cooking time and the time of day (eg. time of day = 08:00, set start cooking time = 11:00; MPT = 15 - 3 = 12 hours).

ELECTRIC CLOCK

Upon immediate connection of the appliance or after a blackout, the “clock indicator light” is flashing. This indicates that it is recommended to check if the time of the day is correct.

- If the time of the day is correct keep the “setting knob” pressed until the “clock indicator light” goes out.
- To set the time of the day press the “setting knob” briefly (repeatedly) until the “clock indicator light” is flashing. Then turn the “setting knob” (to the right or left) to set the time of the day. At the end of the time adjustment, keep the “setting knob” pressed for confirmation until the “clock indicator light” goes out.

MINUTE MINDER

The minute minder function consists only of a buzzer which is automatically activated at the end of the set time (max 3 hours).

Important : It is not possible to use the minute minder function if an automatic cooking has been set.

To set the minute minder press the “setting knob” briefly (one or more times) until the “minute minder indicator light” is flashing.

Then turn the “setting knob” (to the right or left) to set the time.

At the end of the adjustment (within 10 seconds), keep the “setting knob” pressed for confirmation until the “minute minder indicator light” changes from flashing to steadily lit.

Then the countdown starts immediately.

At the end of the time, the “minute minder indicator light” changes from steadily lit to flashing and a buzzer (beep) sounds for one minute.

Press the “setting knob” briefly to stop the buzzer and to turn off the flashing “minute minder indicator light”.

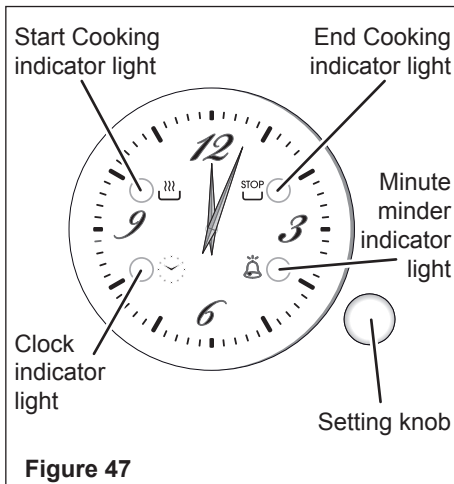

Figure 47

During the minute minder program it is possible, at any time, to display the set time by pressing the “setting knob” briefly (one or more times) until the “minute minder indicator light” is flashing.

To cancel the program before completion, keep the “setting knob” pressed for about 3 seconds until the “minute minder indicator light” goes out; the minute minder function will be cancelled.

**ATTENTION - MOST IMPORTANT:
This is only an alarm that DOES NOT
switch off the oven or grill.
REMEMBER TO TURN OFF THE
OVEN OR GRILL MANUALLY.**

AUTOMATIC COOKING

Use automatic cooking to automatically turn the oven on, cook, and then turn the oven off.

1. Check the clock shows the correct time.
2. Select the function and temperature (function and temperature knobs). The oven will come on.
3. Press the “setting knob” briefly (one or more times) until the “Start Cooking indicator light” is flashing.

Then turn the “setting knob” (to the right or left) to set the start cooking time (not less than 2 minutes and max 12 hours from the current time of the day).

At the end of the adjustment (within 10 seconds), keep the “setting knob” pressed for confirmation until the “Start Cooking indicator light” changes from flashing to steadily lit.

4. Decide how long the food will take to cook, allowing time for preheating if necessary.
Press the “setting knob” briefly (one or more times) until the “End Cooking indicator light” is flashing.

Then turn the “setting knob” (to the right or left) to set the end cooking time (at least 2 minutes from the set start cooking time).

At the end of the adjustment (within 10 seconds), keep the “setting knob” pressed for confirmation until the “End Cooking indicator light” changes from flashing to steadily lit.

If there is time to wait before cooking starts, the oven will switch off but is now set for automatic cooking.

If you are already at home to turn the oven on and only want the oven to turn off automatically, start cooking as normal, then follow step 4 to set a time to stop the oven.

- To see the set start cooking time, press the “setting knob” briefly (one or more times) until the “Start Cooking indicator light” is flashing.
- To see the set stop time, press the “setting knob” briefly (one or more times) until the “End Cooking indicator light” is flashing.
- To cancel the program before completion, keep the “setting knob” pressed for about 3 seconds until the “Start Cooking indicator light” and/or “End Cooking indicator light” go/goes out. **REMEMBER TO TURN OFF THE OVEN OR GRILL MANUALLY.**

When the stop time is reached, the oven will turn off, the “End Cooking indicator light” changes from steadily lit to flashing and a buzzer (beep) sounds for one minute.

- Press the “setting knob” briefly to stop the buzzer and to turn off the flashing “End Cooking indicator light”.
- Turn the temperature and function knobs to the off position.

Attention: After a power failure any automatic program is NOT deleted and the “clock indicator light” is flashing (this indicates that it is recommended to check if the time of the day is correct).

ELECTRONIC CLOCK WITH ALARM

MODELS WITH ELECTRONIC CLOCK WITH ALARM (fig. 48)



The electronic clock is a device which groups the following functions:

- 24 hours clock with illuminated display;
- 99 minutes alarm.

Upon immediate connection of the oven or after a blackout, three zeros will flash on the display.

To set the hour it is necessary to push the “A” button and then, within 7 seconds, the “B” or “C” button until you have set the exact hour.

An energy black-out makes the clock go to zero.

Description of the buttons:		
A	 or other equivalent symbols	Timer
B	 or other equivalent symbols	To decrease the numbers on the digital display
C	 or other equivalent symbols	To increase the numbers on the digital display

ELECTRONIC ALARM

The alarm program consists only of a buzzer which may be set for a maximum period of 99 minutes.

To set the time, push the “B” or “C” button until you obtain the desired time in the display.

Having finished the setting, the  symbol will be lit and the countdown will start immediately.

At the end of the time, an intermittent buzzer, during 7 minutes, will go off; this can be stopped by pressing the “C” button.

To stop the alarm countdown in any moment press the “B” and “C”, buttons together and release the “C” button first.

SETTING THE FREQUENCY OF THE ALARM SOUND

The selection from 3 possibilities of sound can be made by pressing the “B” button.

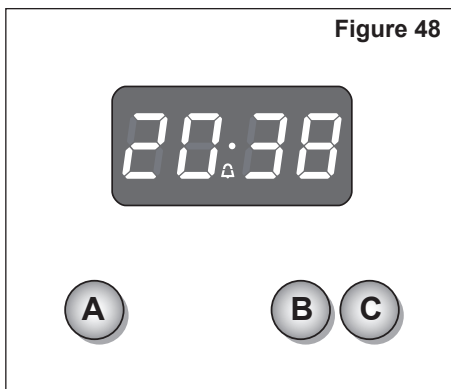



ELECTRONIC CLOCK/END COOKING TIMER

MODELS WITH ELECTRONIC CLOCK/END COOKING TIMER (fig. 49)

The electronic clock/end cooking timer is a device which groups the following functions:

- 24 hours clock with illuminated display;
- timing of oven cooking with automatic switch-off (max 99 minutes).

Description of the buttons:		
A	 or other equivalent symbols	Timer
B	 or other equivalent symbols	To decrease the numbers on the digital display
C	 or other equivalent symbols	To increase the numbers on the digital display

ELECTRONIC CLOCK

Upon immediate connection of the cooker or after a mains failure, three zeros will flash on the display.

To set the clock it is necessary to push the “A” button and then, within 7 seconds, the “B” or “C” button until you have set the correct time.

The clock will show zero after a mains failure.

Attention: When the display shows three zeros the oven cannot be switched on.

The oven can be switched on when the symbol  is shown in the display.

SETTING THE FREQUENCY OF THE ALARM SOUND

The selection from 3 possibilities of sound can be made by pressing the “B” button.

COOKING WITH AUTOMATIC SWITCH-OFF

The aim of this function is to automatically stop the cooking after a preprogrammed time, for a maximum period of 99 minutes.

To set the cooking time, push the “B” or “C” button until you obtain the desired time in the

display. The symbol **AUTO** (or **A**) will be shown in the display. Then set the oven selector and thermostat knobs according to the cooking function and temperature required.

The oven will immediately start to operate and will work for the preprogrammed time. The display shows the count down.

Clock time can be displayed by pressing the “A” button. Once the time has elapsed, the oven will switch off automatically, the symbol **AUTO** (or **A**) will go off and an intermittent buzzer, lasting 7 minutes, will start; this can be stopped by pressing the “C” button.

Important: Before the buzzer is stopped switch off the oven manually.

To cancel the cooking program at any time press the “B” and “C” buttons together and release the “C” button first.

ELECTRONIC ALARM

The electronic clock can be used as an alarm only for a maximum period of 99 minutes.

To set the alarm, push the “B” or “C” button until you obtain the desired time in the display. Once the time has elapsed, an intermittent buzzer, lasting 7 minutes, will start; this can be stopped by pressing the “C” button.

Attention: If the oven is switched on when the buzzer starts, it will be automatically switched off. For it to operate furtherly you have to stop the buzzer by pressing the “C” button.

Then remember to switch the oven off manually.

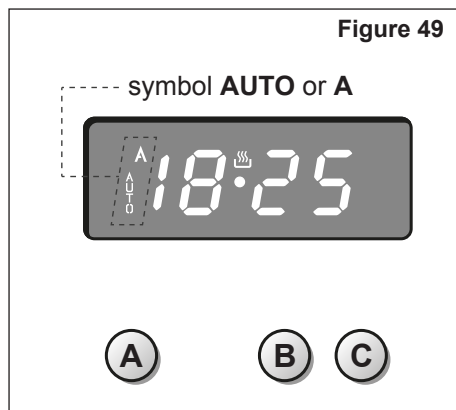



ELECTRONIC CLOCK/PROGRAMMER (START-END COOKING)

MODELS WITH ELECTRONIC CLOCK/PROGRAMMER (START-END COOKING) (figs. 50, ..., 8.8)

The electronic clock/programmer is a device which groups together the following functions:





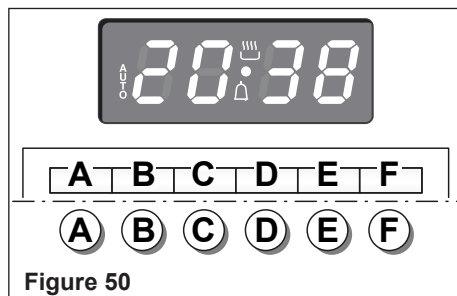

- 24 hours clock with illuminated display;
- timer (up to 23 hours and 59 minutes);
- program for automatic oven cooking;
- program for semi-automatic oven cooking.

Description of the illuminated symbols:

AUTO <i>flashing</i>	Programmer in automatic or semi-automatic position but not programmed.
AUTO <i>illuminated</i>	Programmer in automatic or semi-automatic position with program inserted.
	Oven set for manual cooking or automatic/semi-automatic cooking taking place.
	Timer in operation.
 and AUTO <i>flashing</i>	Program error. (The time of day lies between the calculated cooking start and end time).

Note: Select a function by the respective button and, in 5 seconds, set the required time with the “E” / “F” buttons (“one-hand” operation). After a power cut the display resets to zero and cancels the set programs.



Description of the buttons:		
A	 or other equivalent symbols	Timer
B	 or other equivalent symbols	Cooking time
C	 or other equivalent symbols	End of cooking time
D	 or other equivalent symbols	Manual position, cancellation of the inserted cooking program and set the time of the day
E	 or other equivalent symbols	To decrease the numbers on the digital display
F	 or other equivalent symbols	To increase the numbers on the digital display

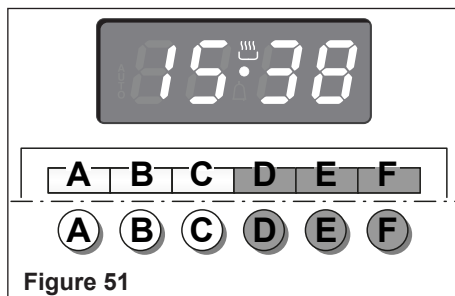

ELECTRONIC CLOCK (fig. 51)

The programmer is equipped with an electronic clock with illuminated numbers which indicates hours and minutes.

Upon immediate connection of the oven or after a power cut, three zeros will flash on the programmer display.

To set the correct time of day it is necessary to push the “D” button and then the “E” or “F” button until you have set the correct time (fig. 51).

In another way push simultaneously the “B” / “C” two buttons and at the same time push the “E” or “F” button.

Note: If the clock is reset it deletes any previously set programs

NORMAL COOKING WITHOUT THE USE OF THE PROGRAMMER

To manually use the oven, without the aid of the programmer, it is necessary to cancel the flashing **AUTO** by pushing the “D” button (**AUTO** will be switched off and the symbol  will illuminate - fig. 52).

Attention: If the **AUTO** is illuminated (which means a cooking program has already been inserted), by pushing the button “D” you cancel the program and return to manual operation.

If the oven is switched on, you must switch it off manually.

ELECTRONIC TIMER

The timer program consists only of a buzzer which may be set for a maximum period of 23 hours and 59 minutes.

If the **AUTO** symbol is flashing push the “D” button.

To set the time, push the “A” button and the “E” or “F” until you obtain the desired time in the display (fig. 53).

Having finished the setting, the clock hour will appear on the panel and the  symbol will be illuminated.

The countdown will start immediately and may be seen at any moment on the panel by simply pressing the button “A”.

At the end of the time, the  symbol will disappear and the buzzer will sound for some minutes or until a button is pressed (not the “E” / “F” buttons).

After a short time the display will revert back to the time of day.

SETTING THE FREQUENCY OF THE AUDIBLE SIGNAL

The buzzer has 3 different tones and can be changed by pressing the “E” button, but only when the time of day is displayed

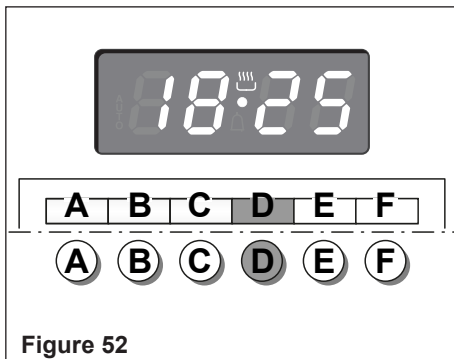

Figure 52

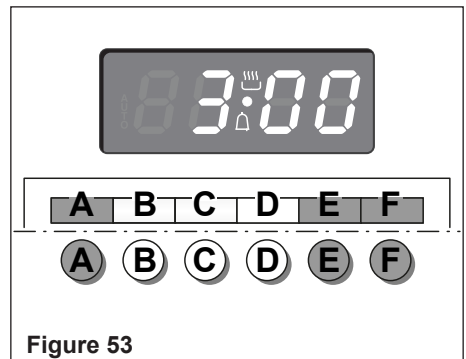



Figure 53

AUTOMATIC OVEN COOKING

To cook food automatically in the oven, it is necessary to:

1. Set the length of the cooking period.
2. Set the end of the cooking time.
3. Set the temperature and the oven cooking program.

These operations are done in the following way:

1. Set the length of the cooking period by pushing the “B” button and the “F” button to increase or “E” to decrease if you have passed the desired time (fig. 54). The **AUTO** and the  symbol will illuminate.

2. Set the end of the cooking time by pressing the “C” button (the cooking time already added to the clock time will appear) and the “F” button (fig. 55); if you pass the desired time you may get back by pushing the “E” button.

After this setting, the  symbol will disappear. If after this setting, the **AUTO** flashes on the display and a buzzer sounds, it means there was an error in the programming, that is that the cooking cycle has been superimposed on the clock. In this case, modify the end of cooking time or the cooking period itself by following again the above mentioned instructions.

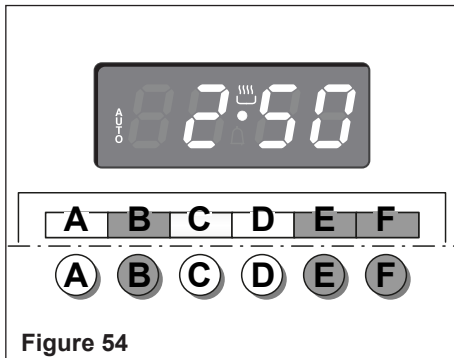



Figure 54

3. Set the temperature and the cooking function by using the switch and thermostat knobs of the oven (see specific chapters).

Now the oven is programmed and everything will work automatically, that is the oven will turn on at the right moment to end the cooking at the established hour.

During cooking, the  symbol remains illuminated.

By pushing the “B” button you can see the time that remains until the end of cooking.

The cooking program may be cancelled at any time by pushing “D”.

At the end of the cooking time the oven will turn off automatically, the  symbol will turn off, **AUTO** will flash and a buzzer will sound, which can be turned off by pushing any of the buttons except the “E” / “F” buttons.

Turn the switch and thermostat knobs to zero and set the programmer onto “manual” by pressing the “D” button.

Attention: After a power cut the clock resets to zero and cancels the set programs.

After a power cut, three zeros will flash on the display.

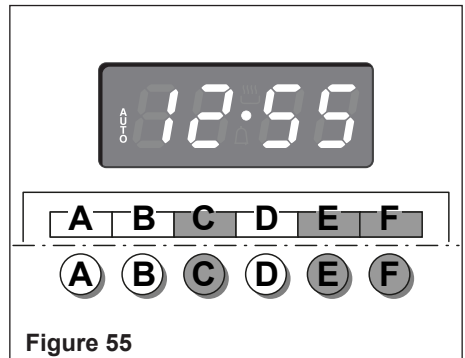

Figure 55

SEMI-AUTOMATIC COOKING

This is used to automatically switch off the oven after the desired cooking time has elapsed.

There are two ways to set your oven:

1. Set the length of the cooking time by pushing the “B” button and the “F” button to advance, or “E” to go backwards if you have passed the desired time (fig. 56).
or
2. Set the end of the cooking time by pushing the “C” button and the “F” button to advance, or “E” to go backwards if you have passed the desired time (fig. 57).

AUTO and the  symbol will be on.

Then set the temperature and the cooking function using the oven switch and thermostat knobs (see specific chapters).

The oven is switched on and it will be switched off automatically at the end of the desired time.

During cooking, the  symbol remains on and by pressing the button “B” you can see the time that remains till the end of the cooking.

The cooking program may be cancelled at any time by pushing “D”.

At the end of the cooking time the oven will turn off automatically, the  symbol will turn off, **AUTO** will flash and a buzzer will sound, which can be turned off by pushing any of the buttons except the “E” / “F” buttons.

Turn the switch and thermostat knobs to zero and set the programmer onto “manual” by pressing the “D” button.

Attention: After a power cut the clock resets to zero and cancels the set programs.

After a power cut, three zeros will flash on the display.

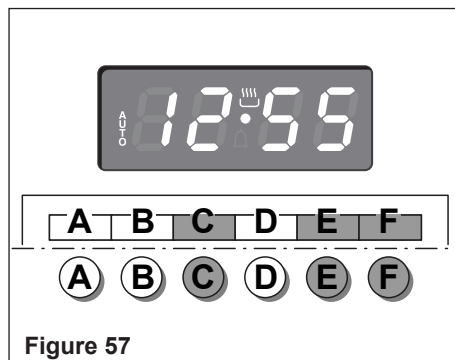
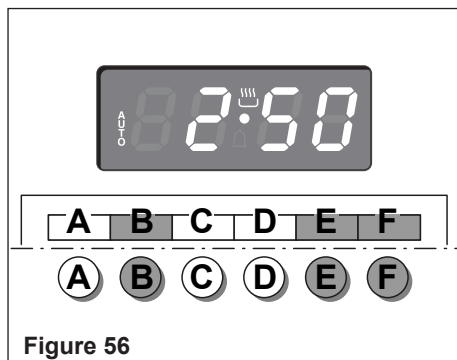

CLOCK and TIMER with “TOUCH CONTROL” KEYS

Keys:		
A and C	⊕ and ⊖ or ⬆ and ⬇ or other equivalent symbols	Touched simultaneously (for more than 2 seconds): <ul style="list-style-type: none"> • setting the clock; • setting the timer volume (by touching once, along with the “B” key); • to cancel automatic cooking at any time.
B	MODE or other equivalent wording / symbol	Function selection (touched for more than 2 seconds): <ul style="list-style-type: none"> • setting the clock (only after first connection or after a power failure); • timer; • automatic cooking “dur” (duration) - how long the food will take to cook (by touching the “B” key again); • automatic cooking “End” - the time you would like the oven turns off (by touching the “B” key two more times).
A	⊖ or ⬇ or other equivalent symbols	Decreases the number shown on the display
C	⊕ or ⬆ or other equivalent symbols	Increases the number shown on the display

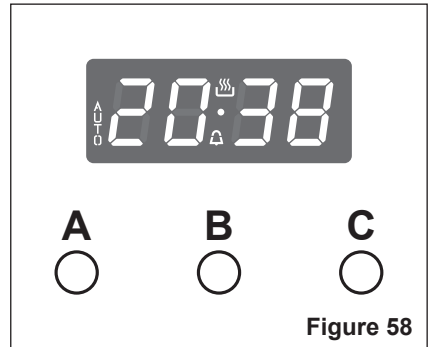

Illuminated symbols:		
AUTO	flashing	Automatic cooking completed, oven in automatic position but not set
AUTO	steady illumination	Oven set for automatic cooking, cooking still not taking place
	flashing	Timer being set
	steady illumination	Timer in operation
	steady illumination	Oven set for manual cooking
and AUTO	AUTO flashing	Automatic cooking being set
and AUTO	steady illumination	Oven set for automatic cooking, cooking taking place

“TOUCH-CONTROL” KEYS

The “touch-control” keys shall be operated by the fingers (just by touching the key). When using touch controls it is best to use the ball of your finger rather than the tip.

The keys are automatically deactivated:

- 8 seconds after the last selection; the deactivation is indicated by an acoustic signal (“beep”).

To reactivate just touch the “B” key or the “A” and “C” keys (simultaneously) for more than 2 seconds.

SETTING THE CLOCK

When first connected, or after a power failure, the digits and “AUTO” will shown on the display.

Important: The oven does not operate, in manual cooking, without first having set the clock.

To set the clock, touch the “B” key, for more than 2 seconds, and then the “A” or “C” keys. To set the clock, with the appliance already connected, touch the “A” and “C” keys simultaneously (for more than 2 seconds), then “A” or “C” keys.

Important:



- changing the time will delete any automatic program;
- after setting the clock, the oven starts to operate in the selected function (manual cooking). The “” symbol is steady illuminated.

USING THE TIMER

You can use the timer at any time, even when the oven is not in use.

The timer does not turn the oven off.

The timer can be set for up to 23 hours and 59 minutes.

- To set the timer, touch the “B” key for more than 2 seconds (the “” symbol flashes), than the “C” or “A” keys.
- After about 8 seconds an acoustic signal (“beep”) will sound confirming the regulation (“” symbol steady illuminated).
- To check the remaining time touch the “B” key for more than 2 seconds. If the remaining time is more than a minute the display will show hours and minutes; if less than a minute the display will show seconds.
- When the time is up, the timer will beep. Touch the “B” key, for more than 2 seconds, to turn it off; or press the “A” or “C” key to stop the beep and than the “B” key, for more than 2 seconds, to deactivate the “” symbol flashing on the display.
- Turn off the oven manually (function and thermostat knobs in the off position) if the manual cooking has been completed.

SETTING THE TIMER VOLUME

You can select from three volume levels.

- Touch the “**A**” and “**C**” keys simultaneously for more than 2 seconds.
- Touch the “**B**” key; you can read on the display the current timer volume (“**ton1**”, “**ton2**” or “**ton3**”).
- Touch the “**A**” key to listen or change the timer volume.
- Timer volume activated: the last displayed.
- After about 8 seconds an acoustic signal (“**beep**”) will sound confirming the volume setting; then the time of day will be displayed.

AUTOMATIC COOKING

Use automatic cooking to automatically turn the oven on, cook, and then turn the oven off.

1. Check the clock shows the correct time.
2. Select the function and temperature (function and temperature knobs). The oven will come on.
3. Decide how long the food will take to cook, allowing time for preheating if necessary.
4. Touch the “**B**” key for more than 2 seconds and then touch again; “**dur**” will show (duration). Using the “**C**” and “**A**” keys, set the cooking time.
5. Decide the time you would like the oven to turn off; touch the “**B**” key for more than 2 seconds and then touch it two times again; “**End**” will show. Using the “**C**” and “**A**” keys, set the stop time.

Note: while “**dur**” is displayed you can change to “**End**” just by touching one time the “**B**” key (within 8 seconds from the last selection).

If there is time to wait before cooking starts, the current time of day and “**AUTO**” will show in the clock display. The oven will switch off but is now set for automatic cooking.

If you are already at home to turn the oven on and only want the oven to turn off automatically, start cooking as normal, then follow step 4 or step 5 to set a time to stop the oven.

When automatic cooking starts, “” will be displayed and the oven will turn on.

- To see the remaining cook time, follow step 4 up to display “**dur**” (duration).
- To see the set stop time, follow step 5 up to display “**End**”.
- To cancel automatic cooking at any time, touch the “**A**” and “**C**” keys simultaneously (for more than 2 seconds) and turn the temperature and function knobs to the off position.

When the stop time is reached, the oven will turn off, the timer will beep and “**AUTO**” will flash:

- Touch any key to stop the beeping.
- Touch the “**B**” key, for more than 2 seconds, to return the oven to the manual mode (“” symbol steady illuminated on the display).
- Turn the temperature and function knobs to the off position.

Attention: After a power failure any automatic program is deleted. Turn off the oven manually.

CLEANING AND MAINTENANCE

GENERAL ADVICE

- **Before you begin cleaning, you must ensure that the appliance is switched off and disconnected from the electrical power supply.**
- It is advisable to clean when the appliance is cold and especially when cleaning the enamelled parts.
- Avoid leaving alkaline or acidic substances (lemon juice, vinegar, etc.) on the surfaces.
- Avoid using cleaning products with a chlorine or acidic base.
- **Do not use a steam cleaner because the moisture can get into the appliance thus make it unsafe.**
- **Important: The use of suitable protective clothing/gloves is recommended when handling or cleaning of this appliance.**
- **Do not use harsh abrasive cleaners or sharp metal scrapers to clean the oven door glass since they can scratch the surface, which may result in shattering of the glass.**

WARNING!

When correctly installed, your product meets all safety requirements laid down for this type of product category. However special care should be taken around the rear or the underneath of the appliance as these areas are not designed or intended to be touched and may contain sharp or rough edges, that may cause injury.

ENAMELLED PARTS

All the enamelled parts must be cleaned with a sponge and soapy water or other non-abrasive products.

Dry preferably with a microfibre or soft cloth.

Acidic substances like lemon juice, tomato sauce, vinegar etc. can damage the enamel if left too long.

STAINLESS STEEL, ALUMINIUM PARTS, PAINTED AND SILK-SCREEN PRINTED SURFACES

Clean using an appropriate product.

Always dry thoroughly.

IMPORTANT: these parts must be cleaned very carefully to avoid scratching and abrasion. You are advised to use a soft cloth and neutral soap.

CAUTION: Do not use abrasive substances or non-neutral detergents as these will irreparably damage the surface.

GLASS CONTROL PANEL

Clean using an appropriate product. Always dry thoroughly.

Do not use harsh abrasive cleaners or sharp metal scrapers to clean the control panel since they can scratch the surface, which may result in shattering of the glass.

INSIDE OF OVEN

- The oven should always be cleaned after use when it has cooled down. **Let the oven cool down and pay special attention no to touch the hot heating elements inside the oven cavity.**
- The cavity should be cleaned using a mild detergent solution and warm water.
- Suitable proprietary chemical cleaners may be used after first consulting with the manufacturers recommendations and testing a small sample of the oven cavity.
- Abrasive cleaning agents or scouring pads/cloths should not be used on the cavity surface.
- **NOTE:** The manufacturers of this appliance will accept no responsibility for damage caused by chemical or abrasive cleaning.



Do not store flammable material in the oven.

GRILL HEATING ELEMENT

- The heating element is self-cleaning and does not require maintenance.

REPLACING THE OVEN LIGHTS

WARNING: Ensure the appliance is switched off before replacing the lamp to avoid the possibility of electric shock.

- Let the oven cavity and the heating elements to cool down.
- Switch off the electrical supply.
- Remove the protective cover (fig. 59).
- Replace the halogen lamp with a new one suitable for high temperatures having the following specifications: 220-240 V or 230-240 V, 50 Hz and same power (check watt power as stamped in the bulb itself) of the replaced lamp.

IMPORTANT WARNING: Never replace the lamp with bare hands; contamination from your fingers can cause premature failure. Always use a clean cloth or gloves.

- Refit the protective cover.

NOTE: Oven bulb replacement is not covered by your guarantee.

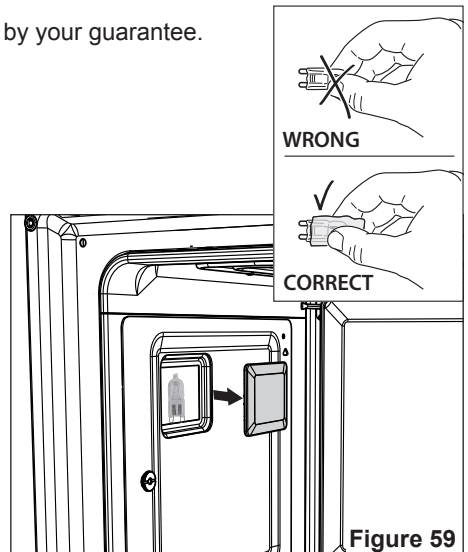

Figure 59

TILTING GRILL (SOME MODELS ONLY)

- The grill is secured to the rear wall of the oven on a hinge system that allows it to be lowered to allow proper access when cleaning the oven ceiling (fig. 60).
- To lower the grill element: Pull both the securing clips forward to release the element. The element will now drop down to enable cleaning.
- When you have finished cleaning the oven ceiling, pull the securing clips forward, raise the element and release the clips. Make sure the element is securely held in place.
- The grill element itself is self-cleaning.

Figure 60

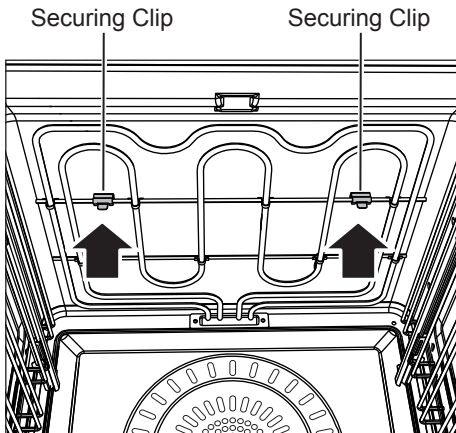
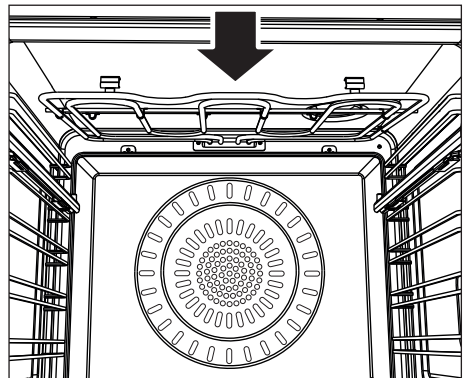

Figure 61



REMOVING AND REPLACING THE INNER DOOR GLASS PANES FOR CLEANING

If you wish to clean the inner panes of glass of the door, make sure you follow the precautions and instructions very carefully.

Replacing the glass panes and the door incorrectly may result in damage to the appliance and may void your warranty.

IMPORTANT!

- Take care, the oven door is heavy. If you have any doubts, do not attempt to remove the door.
- Make sure the oven and all its parts have cooled down. Do not attempt to handle the parts of a hot oven.
- Take extreme care when handling the glass panes. Avoid the edges of the glass bumping against any surface. This may result in the glass shattering.
- **CAUTION:**
Do not use harsh abrasive cleaners or sharp metal scrapers to clean the oven door panes of glass since they can scratch the surface, which may result in shattering of the glass.
- If you notice any sign of damage on any of the glass panes (such as chipping, or cracks), do not use the oven. Call your Authorised Service Centre or Customer Care.
- Make sure you replace the glass panes correctly. Do not use the oven without glass panes correctly in place.
- If the glass panes feel difficult to remove or replace, do not force them. Call your Authorised Repairer or Customer Care for help.
Note: service visits providing assistance with using or maintaining the oven are not covered by your warranty.

REMOVING THE OVEN DOOR

The oven door can easily be removed as follows:

- Open the door to the full extent (fig. 62).
- Locate the two small metal locking levers on both door hinges either side (fig. 62).
- Push each locking lever down fully to release the door from the hinge (fig. 63).
Allow the door to close up to the first stop position (fig. 64).
- Holding the door on both sides, carefully pull the door out and away from the hinges (fig. 64).

⚠ Never carry out this operation with the door completely open (fig. 65). The door hinges could unhook and close suddenly and unexpectedly with risk of injury.

- Rest the door on a soft surface.
- To replace the door, repeat the above steps in reverse order.

IMPORTANT! Ensure the levers are both fully locked before trying to shut the door.

Always keep a safe distance from the door hinges, paying special attention to the position of your hands.

Figure 62

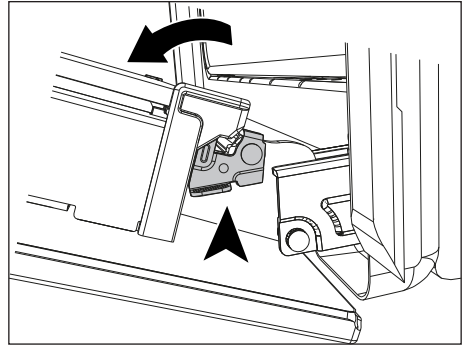

Figure 63

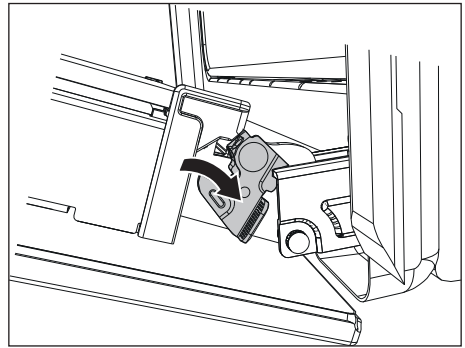

Figure 65

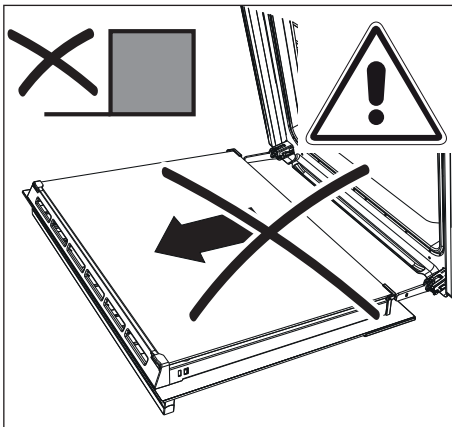
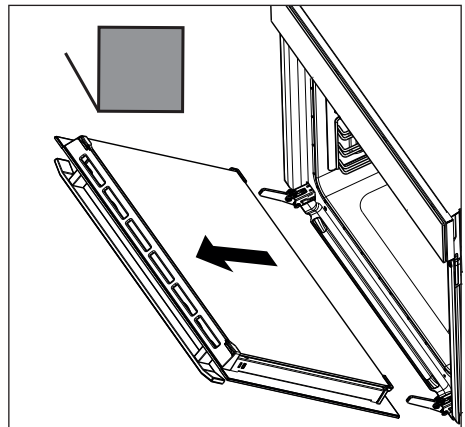
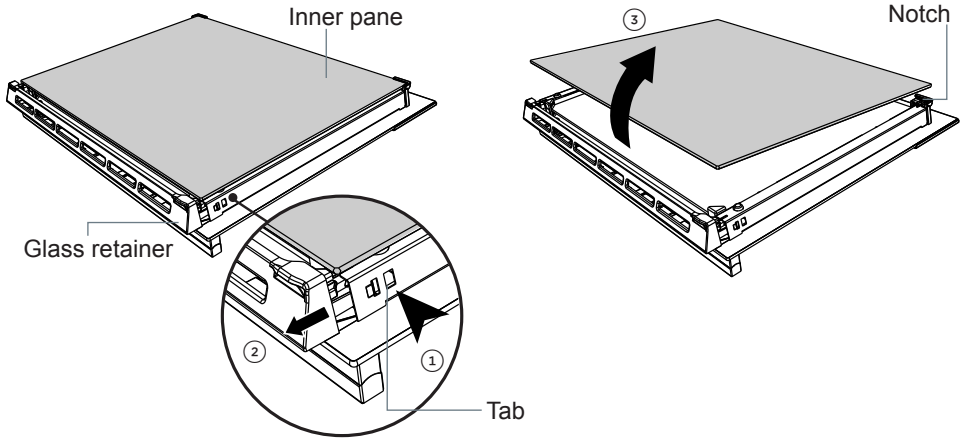

Figure 64



To remove the inner pane

- ① Touch the glass retainer tabs in on both sides of the door.
- ② Pull the glass retainer up until the tabs relocate in the topmost hole.
- ③ Holding the top of the inner pane, gently pull the pane toward the top of the door until the pane is clear of the notch at the bottom of the glass.



To remove the middle pane (some models only)

- ④ Touch the glass retainer tabs in on both sides of the door again. The glass retainer can then be pulled off completely.
- ⑤ Gently pull the middle pane toward the top of the door until the pane is clear of the notch at the bottom of the door.
- ⑥ Lift the pane out. The rubber stoppers at the top of the pane remain attached to the glass pane.

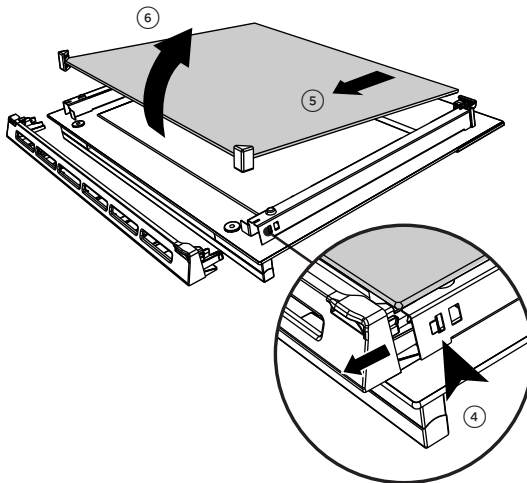

After cleaning replace the door glass panes

When replacing the glass panes make sure that

- you replace the inner pane correctly as shown. The pane must be in the position described below in order to fit into the door and to ensure that the oven operates safely and correctly
- you take extra care not to bump the edges of the glass against any object or surface you do not force any of the panes into place. If you are experiencing difficulties replacing the panes, remove them and start the process again from the beginning. If this still does not help, call Customer Care.

Replace the middle pane (some models only)

Ensure the pane is the right way up (the black strip and warning text at the bottom of the pane should be readable back to front when the pane is fitted correctly).

- ① Ensure the rubber stoppers are still attached at the top to the pane.
- ② Slot the bottom of the pane into the lower notch at the bottom of the door.
- ③ Lower the pane into the door, the rubber stoppers rest on the outer pane of glass.

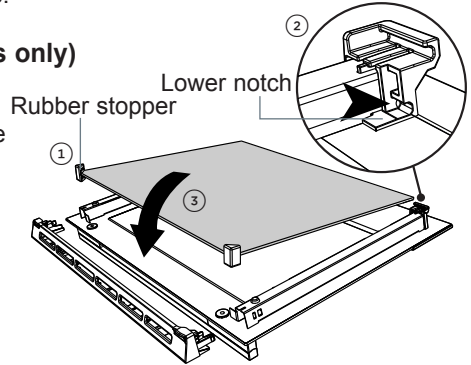

Replace the inner pane

Ensure the pane is the right way up (ie the logo should be readable at the bottom of the door)

- ④ Slide the pane into the notch at the bottom of the door.
- ⑤ Lower the pane onto the notch at the top of the door.
- ⑥ Slide the glass retainer back into place and ensure it is fully clipped securely in place.

IMPORTANT!

Make sure the glass retainer is correctly and firmly in place and the glass pane is secure.

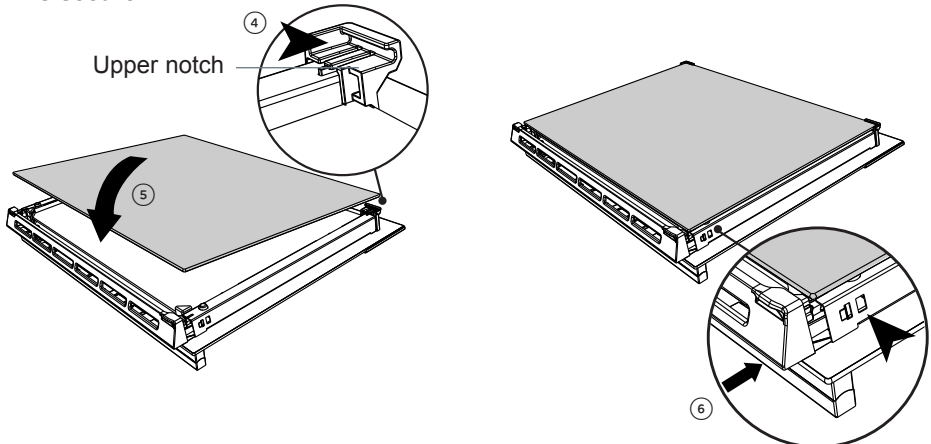

SERVICE AND MAINTENANCE

SERVICING THE APPLIANCE

Service may be obtained by contacting our Customer Service Centre to locate the nearest Authorised Delonghi Service Agent:

Servicing shall be carried out only by authorized personnel.

The appliance shall not be modified.

TROUBLESHOOTING

If you experience a problem with your oven, check the following points before calling our Customer Service Centre for assistance.

1. The power is switched on.
2. The controls are switched on.
3. None semi-automatic or automatic cooking program has been selected.
4. Both the fuse and the mains fuse are intact.

Should you still require assistance please contact our Customer Service Centre for your nearest Authorised Delonghi Service Agent.

Descriptions and illustrations in this booklet are given as simply indicative. The manufacturer reserves the right, considering the characteristics of the models described here, at any time and without notice, to make eventual necessary modifications for their construction or for commercial needs.

www.delonghi.com.au
www.delonghi.co.nz

