

**FISHER & PAYKEL**

**FRONT LOADER  
WASHING MACHINE**

---

WH1060P, WH1060J, WH9060P, WH9060J, WH8560F, WH8560P,  
WH8560J, WH8060F, WH8060P, WH8060J,  
WH7560P & WH7560J

**INSTALLATION GUIDE / USER GUIDE**  
**NZ AU SG**



## CONTENTS

---

Safety and warnings	5
Installation guide	7
Before your first wash	15
Safety features	16
Control panel	18
Wash cycles	22
Detergent and softener	27
Where to put the detergent	28
Wash preparation	31
Getting started quickly	32
Wash cycle options	34
Customising a wash cycle	41
Changing pre-set options	43
Caring for your washer	45
Before you call for service	50
Fault codes	52
Troubleshooting	53
Manufacturer's warranty	59
Customer care	61

---

### Registration

To register your product visit our website: [fisherpaykel.com/register](https://fisherpaykel.com/register)



### **⚠ WARNING!**



#### **Electric Shock Hazard**

**Failure to follow this advice may result in electric shock or death.**

- If you are using an extension cord or a portable electrical outlet device (eg multi-socket outlet box), ensure that it is positioned so that it does not come into contact with water or moisture.

## **READ AND SAVE THIS GUIDE**

**When using your clothes washer, follow basic precautions, including the following:**

### **General**

- This product has been designed for personal, family or household use. This product is not designed for any commercial use. Any commercial use will terminate this product's manufacturer's warranty.
- A damaged power cord must be replaced by a Fisher & Paykel trained and supported service technician or similarly qualified person in order to avoid a hazard. Do not use the appliance until it has been repaired to avoid a risk of electric shock.
- Do not operate this machine if it has been damaged during transport. Contact your Fisher & Paykel dealer or Fisher & Paykel trained and supported service technician.
- This clothes washer is not intended for use by persons (including children) with reduced physical, sensory or mental capabilities, or lack of experience and knowledge, unless they are supervised or given instructions on how to use the washer by someone responsible for their safety.
- Keep children away from the washer while it is in operation.
- Supervise children to ensure they do not play with the washer or climb inside the drum.
- The washer should only be used for washing and rinsing of textiles where this is indicated on the care label.
- Do not add petrol, dry-cleaning solvents, or other flammable or explosive substances to the wash water. These substances give off vapours that could ignite or explode.
- Do not wash articles that have been previously cleaned in, washed in, soaked in, or spotted with gasoline, dry-cleaning solvents, or other flammable or explosive substances as they give off vapours that could ignite or explode.
- The door will be locked from the start of the cycle until the cycle is complete for safety reasons. It is possible to open the door during the cycle under certain conditions. Never force the door open.
- Do not touch the door during a cycle as the door can become hot.
- When 90°C temperature is selected, the door glass will become hot. Do not touch the glass part of the door. Keep children away from the washer.
- Do not touch or operate the machine with wet hands or with bare-feet.
- Do not open the detergent dispenser during the cycle as hot water may come out of it.
- Ensure the installation provides accessibility to the plug or incorporate a switch in the fixed wiring in accordance with the wiring rules to allow disconnection of the appliance from the supply after installation.

## SAFETY AND WARNINGS

- Read and follow the detergent manufacturers' instructions carefully. Instructions on how to use the detergent will be clearly indicated on the pack. Remember to store your detergents out of the reach of children.
- Do not wash an electric blanket in your washer unless the care label specifically states it is safe to do so.
- Do not wash curtains in this washer, as sunlight makes them brittle and they may disintegrate during washing.
- The only user-removable parts of the washer are the inlet hose(s), dispenser and pump filter. No other parts are designed to be removed by anyone other than a Fisher & Paykel trained and supported service technician.
- Do not overload your washing machine beyond its rated capacity.

MODEL CODE	MAXIMUM CAPACITY* (KG)
WH7560P, WH7560J	7.5
WH8060F, WH8060P, WH8060J	8.0
WH8560F, WH8560P, WH8560J	8.5
WH9060J, WH9060P	9.0
WH1060P, WH1060J	10.0

\*Capacity refers to the maximum dry weight of items the washer can wash at any one time

### Installation

- For guidance on how to install your product, please refer to 'Installation guide' contained in this document.
- Install the machine on a solid and level floor surface ensuring it has at least 20mm clearance on each side. The washer must not be installed on any textured floor coverings (eg carpet, rugs).
- This washer must not be installed or operated on a plinth.

### Water supply requirements

- Inlet water pressure: Max. 1MPa (145psi), Min. 30kPa (4.5psi)
- Inlet water flow rate: Min. 6 litres/minute
- A pressure-reducing valve must be installed if pressure is higher than 1MPa.
- For optimum wash performance check the supply pressure is within the recommended range.
- New hose sets provided with the washer should be used to connect the washer to the water mains. Old hose sets should not be re-used.
- We recommend the inlet hose(s) are changed every five years. **WARNING:** Failure to do so may result in a flood and damage to property.
- The hot water temperature should not exceed 65°C and the cold water temperature should not exceed 35°C. Temperatures above these may cause the machine to fault or cause damage to the machine.

### Disposal

- When disposing of the washer, it is recommended that the door is removed to avoid children getting trapped inside, and that the electrical cable is cut off close to the washer.

# INSTALLATION GUIDE

## Accessories

Check if you received the following accessories with your Fisher & Paykel washer. You will find them inside the drum or attached to the packaging.

- 1 x hot inlet hose (grey with red connectors) for WH8560F, WH8560P2, WH8060F, WH8060P2 and WH7560P
- 1 x cold inlet hose (grey with white connectors) for all models.
- 4 x Plastic plugs to cover transit bolt holes
- 1 x Drain hose guide

## Unpacking

Your washer is heavy, we recommend two people to remove the packaging.

To ensure the best performance from your new washer please follow the steps below before using your washer.

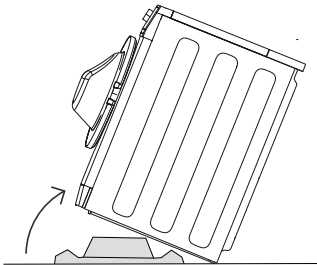

- ① Remove the outer packaging including the polystyrene packer and plastic wrapping.
- ② Lift the washer off the base.
- ③ Remove all packaging and accessories from inside the drum.
- ④ Dispose of all packaging sustainably, ensuring these materials are kept out of the reach of children.

# INSTALLATION GUIDE

## Removing transit safety bolts

- The clothes washer is fitted with transit safety bolts at the rear to avoid possible damage to the internal components during transportation.
- The four transit bolts must be removed prior to operation of the washer. Failure to remove these will result in damage to the washer and compromise your manufacturer's warranty.
- The transit bolts must be removed in order to use the power cord.

## Removing the transit bolts

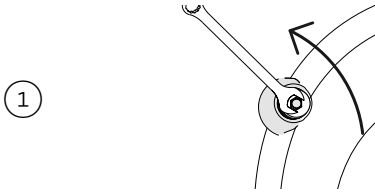

Use a spanner or socket to unscrew and remove all four transit bolts at the back of the washer.

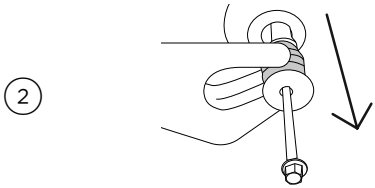

To remove the bolt, grommet and white plastic spacers, pull on the black rubber grommets.

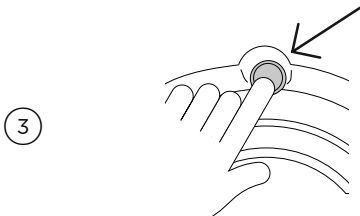

Cover the transit bolt holes with the plastic plugs delivered with the washer. Push to clip into place.



# INSTALLATION GUIDE

## Product dimensions

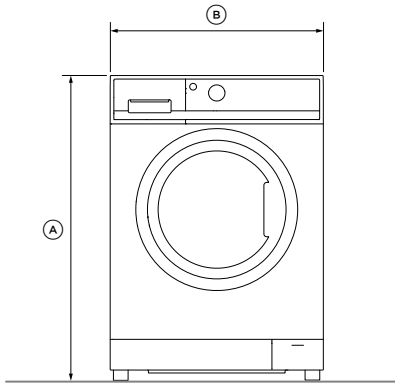

FRONT

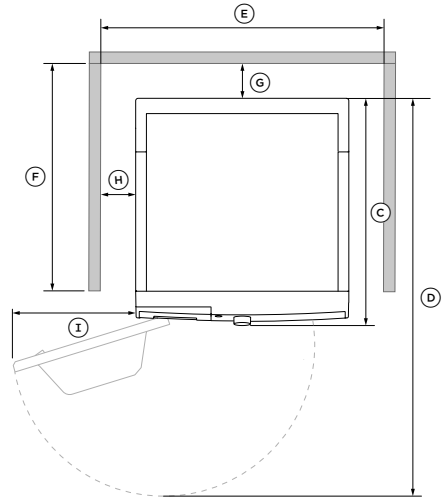

PLAN

PRODUCT DIMENSIONS	WH1060P/J	WH9060P/J	WH8560F/P/J	WH8060F/P	WH7560P/J	WH8060J
	MM	MM	MM	MM	MM	MM
Ⓐ Overall height*	850	850	850	850	850	850
Ⓑ Overall width	600	600	600	600	600	600
Ⓒ Overall depth**	655	655	655	655	590	590
Ⓓ Depth of open door	1075	1075	1075	1075	1010	1010
Standpipe height min	600	600	600	600	600	600

\* Exact height is dependent on foot adjustment

\*\* Including dial and door (when closed)

MIN. CLEARANCES	WH1060P/J	WH9060P/J	WH8560F/P/J	WH8060F/P	WH7560P/J	WH8060J
	MM	MM	MM	MM	MM	MM
Ⓔ Cavity width	640	640	640	640	640	640
Ⓕ Cavity depth	650	650	650	650	610	610
Ⓖ Rear	20	20	20	20	20	20
Ⓗ Sides***	20	20	20	20	20	20
Ⓘ Door to sides	320	320	320	320	330	330

\*\*\* Door clearance should also be considered depending on type of installation

# INSTALLATION GUIDE

## Levelling the washer

It is **IMPORTANT** to level the washer. Having a level washer set up in its cavity will ensure best performance for spinning, minimising noise, vibrations and wear and tear on the washer.

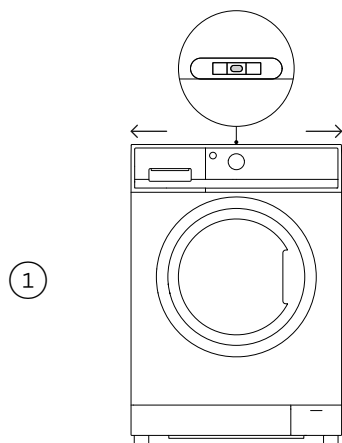

Before positioning your washer in its final position, check that the machine is level, front to back and side to side.

Level the washer side to side:

- ① Place the level on the centre front of the washer.
- ② If you need to adjust the washer's position, loosen the lock nut using the spanner provided and turn the feet up or down until the washer is level side to side.

To wind the feet up turn clockwise, to wind the feet down turn counter-clockwise.

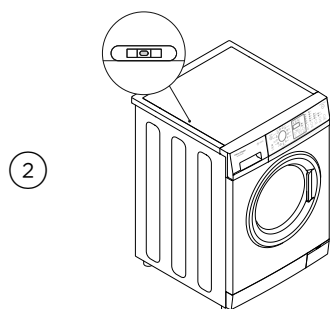

Level the washer front to back:

- ① Place the level on the left side, in line with the centre of the washer.
- ② Adjust the front left foot and then the right foot until the washer is level.

There should be equal weight on both front feet.

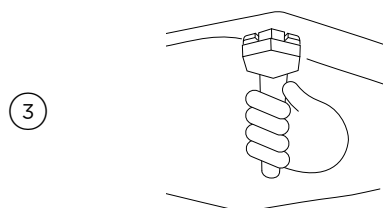

**Using the spanner provided, tighten the lock nuts against the base of the washer to lock the feet in position.**

Move and centre the washer into its final position within the cavity, using adjacent walls as a guide and allowing 20mm clearance at the back and sides of the washer.

Recheck the washer is level, front to back and side to side. Repeat the above steps if required.

# INSTALLATION GUIDE

## Water supply

### Water supply requirements

If you have an uncontrolled water heating source (eg a wet back or solar heating system) you should fit a tempering valve. This will ensure the hot water temperature remains within safe limits. Contact your registered plumber to select and install the tempering valve.

Your cold water should not exceed 35°C and your hot water should not exceed 65°C. Temperatures above these may cause the washer to fault or cause damage to the washer.

- Inlet water static pressure: Max. 1MPa (145psi) Min. 30KPa (4.5psi).
- Inlet water flow rate at tap: Min. 6 litres/min.

### Inlet hose(s)

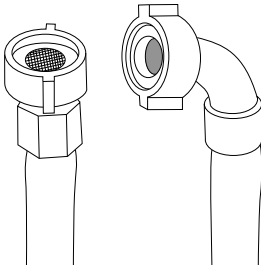

**Failure to adhere to the following guidance may result in a flood and damage to property. Only use the new hose set(s) provided with your washer.**

- ① Connect the straight ends of the inlet hose(s) to the tap(s), there are washers fitted in both ends.
- ② Connect the elbow ends to the corresponding washer inlet valves. If present, the hot valve is coloured orange to make this easier.
- ③ Tighten the inlet hose(s) ends by hand until the hose seal just makes contact with the tap-sealing face. Continue to tighten a further half-turn.
- ④ Make sure there are no kinks in the hose(s).
- ⑤ Turn the tap(s) on and check for leaks. Check for leaks again after 24 hours.

### Cold supply only

For models WH8560F, WH8560P2, WH8060F, WH8060P2, and WH7560P, if you only have a cold water supply, you must connect the inlet valve cap (blanking cap) provided with your washer to the hot inlet valve. The cap prevents water leaking out of the hot valve. This appliance incorporates backflow protection complying with AS3500.1/IEC61770. No further backflow protection is required for connection to the water supply.

Your washer has an internal heater to heat water. If you do not connect a hot water inlet hose, your washer will automatically recognise there is no hot water supply and its internal heater will heat the cold water to the selected cycle temperature.

# INSTALLATION GUIDE

## Draining

In multi-storey apartments or any upper floor, the washer should be installed on a floor equipped with a drain. Draining must comply with local by-laws.

### Place the drain hose in a tub or standpipe

The hose guide is used to hold the drain hose over the tub or standpipe.

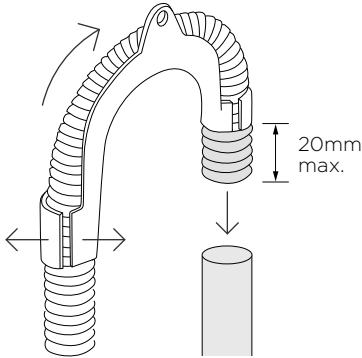

- ① Flex the guide apart and pull the hose through the guide.
- ② Ensure a maximum of 20mm of hose is left exposed at the end.
- ③ Secure the hose guide to prevent it dislodging from the standpipe or tub.

If the drain hose is placed on the ground or if the tub or standpipe is less than 600mm high, the washing machine will continuously drain (siphon) while being filled.

Tub or standpipe height should be a minimum of 600mm.

Regularly check that your tub or standpipe is free from lint or other obstructions. This may affect operation or cause flooding.

### Attach drain hose to spigot

The hose guide is used to hold the drain hose high enough to prevent continuous draining (siphoning).

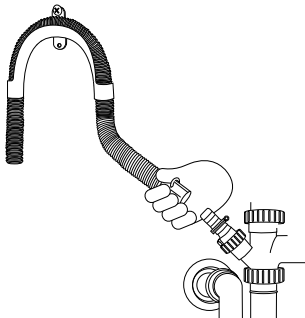

- ① Flex the guide apart and pull the hose through the guide.
- ② Secure the hose guide to a wall or the back wall of the cupboard using a screw.
- ③ Drill out the blanking insert from spigot to ensure the washer can drain correctly.
- ④ Attach drain hose to spigot and secure using a hose clamp.
- ⑤ Check for leaks.

# INSTALLATION GUIDE

## Electrical connection

- This appliance must be connected to a 220V - 240V, 50Hz, sinusoidal, minimum 10A electrical supply.
- Check the power cord for damage and make sure it is not squashed or twisted when installing the washer.
- Always remove the power cord from a socket by the plug, not by the cord.

## Spare Parts

SPARE PART*	PART NO.
Hose inlet long (2m)	422680P
Hose inlet large bore	426123P

\*Available from your Fisher & Paykel dealer or a Fisher & Paykel trained and supported service technician

## Complete your installation

- Turn on the water and check all hose connections for leaks. Make sure there are no kinks in the hose(s). Check the hose connections for leaks again after 24 hours.
- Uncoil power cord, remove and discard the plastic pin cover, and plug into the wall socket.
- Connect the appliance to an earthed outlet protected by a fuse of suitable capacity.

## Test cycle

Your washer must be correctly installed before use. To check the installation and operation of the washer follow the steps below:

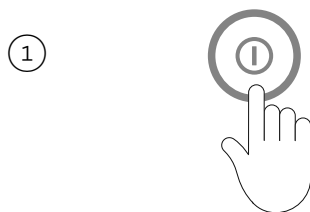

Press ① to activate your washer.



Select a **QUICK** cycle. Ensure the drum is empty and the door closed.

# INSTALLATION GUIDE

3



Press ►|| to start. The washer will start to fill.

4

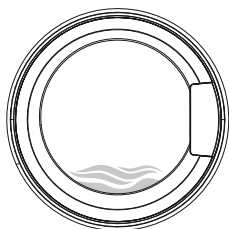

Wait until you see water in the bottom of the drum.

5

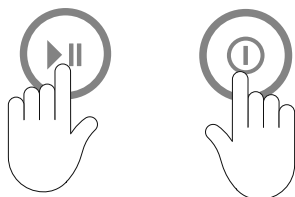

Press ►|| to stop the cycle, then press ① to turn the washer off.

6



Press ① again, select the **SPIN** cycle and press ►||.

Check the drain hose is firmly secured to the standpipe or tub, or spigot.

Observe that the washer pumps out the water, and spins.

The washer will beep to signal the end of the cycle. Any faults will be displayed on the screen, refer to 'Fault codes'.

A test cycle must be carried out anytime the washer is moved or tipped, this will ensure the washer has been correctly re-installed.

If there are any problems, you must address these before proceeding with normal use. The washer will automatically turn off at the end of the cycle if there are no problems.

## BEFORE YOUR FIRST WASH

---

### Check you have done everything you need to before you start your first wash:

- Have the packaging and transit bolts been removed?
- Is the washer correctly levelled, feet are extended and cabinet corners are clear of the floor?
- Is the drain hose threaded through the hose guide 'U bend' (with no more than 20mm extended) and hooked into your standpipe or tub, or attached to a spigot?
- Have the taps been turned on?
- Is the hot hose connected to the hot valve marked 'H'?
- Is the cold hose connected to the cold valve marked 'C'?
- Have you performed the test cycle? Refer to 'Installation guide'.
- Has the power cord been connected to an appropriate power supply and the power turned on?
- Complete a Drum Clean cycle with half-load amount of detergent and without a load in order to remove any residues remaining in the machine from the manufacturing process.

## SAFETY FEATURES

---

### Add a Garment (F/P models)

The **ADD A GARMENT** function can be used to interrupt the cycle to add or remove a garment at any time during the wash part of the cycle (provided the wash temperature selected is lower than 60°C). If necessary the water in the washer will be drained to a level where the door can be opened. Refer to 'Wash cycle options' for more information.

### Drum light (WH1060P, WH9060P, WH8560F, WH8060F, WH8560P3 and WH8060P3 models only)

Your washer has a drum light to help assist you when loading and unloading your washer. When you press **1**, the LED light in the drum will turn on, after two minutes it will automatically turn off. At the end of the cycle, the drum light will turn on again for five minutes to help facilitate unloading.

### Door lock

The door of your washer will lock once you press **▶||** and will stay locked until the washer beeps at the end of the cycle, ensuring safety for you and your family while your washer is operating.

### To unlock the door during a cycle

1



You can open the door to add or remove items during the wash simply by pressing the **▶||** button.

The door will remain locked if the temperature inside the washer is above 60°C and/or the water level is above the bottom of the door seal (a warning will be displayed in these circumstances).

### Your washer also has the following protective measures:

- Flood protection – turns off valves and turns pump on if a flood condition is detected.
- Out-of-balance protection – stops and redistributes the load if an unbalanced load condition is sensed, and/or slows the spin speed to compensate.
- Excess suds protection – pauses to allow suds to break down before continuing the cycle.



## SAFETY FEATURES

### Opening the door during a power failure

Do not attempt to do this if the water level in the washer is above the bottom of the door. If there is a power failure during a wash cycle your washer will stop and the door will remain locked.

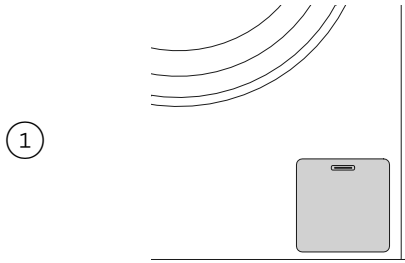

Locate the pump filter cover at the bottom right of your washer.

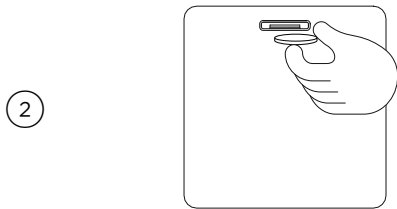

Place a coin or key in the slot and tilt it upwards to lever the cover open.

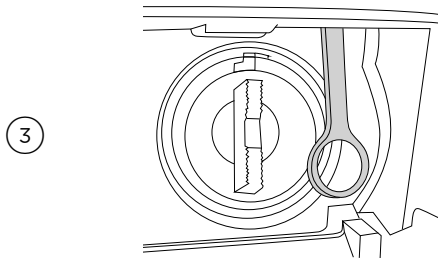

Pull the door release tab down from the ring. Use a screwdriver tip, pen or key to get a good grip.

When power is restored, your washer will resume the interrupted wash cycle. If the cycle doesn't resume automatically, simply press **⏪** to restart your washer.

## CONTROL PANEL

### WH8560F and WH8060F models

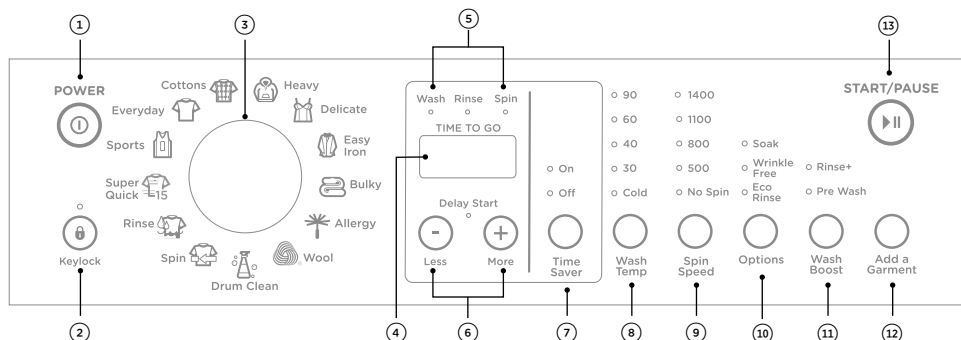

①	<b>Power</b>	Press to turn the washer ON/OFF.
②	<b>Keylock</b>	Press to disable all buttons on the control panel, except the <b>POWER</b> button. This prevents accidental button presses.
③	<b>SmartTouch™ Control Dial</b>	Rotate to select your desired wash cycle. <ul style="list-style-type: none"> <li>Red LED illuminates to indicate the selected wash cycle.</li> </ul>
④	<b>Digital display screen</b>	Shows the following: <ul style="list-style-type: none"> <li><b>TIME TO GO</b> - the remaining time in the cycle that is currently running.</li> <li>Delayed start time of wash cycle.</li> <li>Notifications if an error is detected or a warning is necessary.</li> </ul>
⑤	<b>Progress lights</b>	Indicates the current status of the wash cycle. <ul style="list-style-type: none"> <li>All lights are illuminated at the start of the wash cycle.</li> <li>The light of the current status flashes, and then turns off once completed.</li> </ul>
⑥	<b>Delay Start Less/More</b>	Press <b>MORE +</b> to increase and <b>LESS -</b> to decrease the delay start time.
⑦	<b>Time Saver</b>	Press to turn <b>TIME SAVER</b> ON/OFF.
⑧	<b>Wash Temp</b>	Press to increase or decrease wash water temperature.
⑨	<b>Spin Speed</b>	Press to increase or decrease spin speed.
⑩	<b>Options</b>	Press to select <b>ECO RINSE</b> , <b>WRINKLE FREE</b> and/or <b>SOAK</b> .
⑪	<b>Wash Boost</b>	Press to select <b>PRE WASH</b> or <b>RINSE+</b> .
⑫	<b>Add a Garment</b>	Press to interrupt the wash part of the cycle to add or remove a garment.
⑬	<b>Start/Pause</b>	Press to start or pause the selected wash cycle.

## CONTROL PANEL

### WH1060P, WH9060P, WH8560P3 and WH8060P3 models

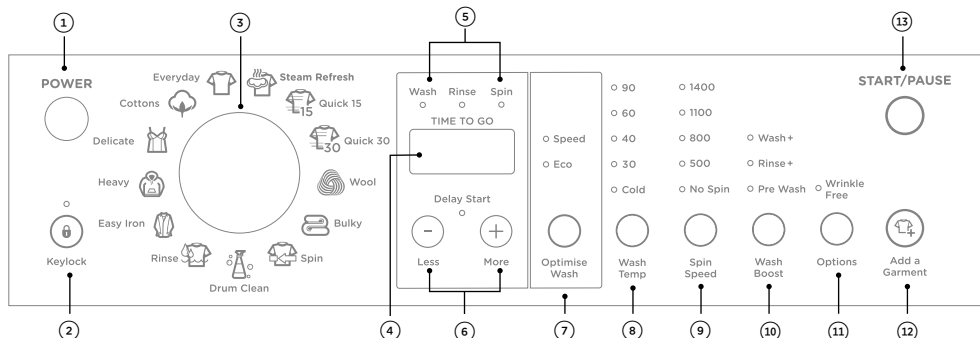

① <b>Power</b>	Press to turn the washer ON/OFF.
② <b>Keylock</b>	Press to disable all buttons on the control panel, except the <b>POWER</b> button. This prevents accidental button presses.
③ <b>SmartTouch™ Control Dial</b>	Rotate to select your desired wash cycle. <ul style="list-style-type: none"> <li>Red LED illuminates to indicate the selected wash cycle.</li> </ul>
④ <b>Digital display screen</b>	Shows the following: <ul style="list-style-type: none"> <li><b>TIME TO GO</b> - the remaining time in the cycle that is currently running.</li> <li>Delayed start time of wash cycle.</li> <li>Notifications if an error is detected or a warning is necessary.</li> </ul>
⑤ <b>Progress lights</b>	Indicate the current status of the wash cycle. <ul style="list-style-type: none"> <li>All lights are illuminated at the start of the wash cycle.</li> <li>The light of the current status flashes, and then turns off once completed.</li> </ul>
⑥ <b>Delay Start Less/More</b>	Press <b>MORE +</b> to increase and <b>LESS -</b> to decrease the delay start time.
⑦ <b>Optimise Wash</b>	Press to select <b>ECO</b> or <b>SPEED</b> .
⑧ <b>Wash Temp</b>	Press to increase or decrease wash water temperature.
⑨ <b>Spin Speed</b>	Press to increase or decrease spin speed.
⑩ <b>Wash Boost</b>	Press to select <b>PRE WASH</b> , <b>RINSE</b> or <b>WASH+</b> .
⑪ <b>Options</b>	Press to select <b>WRINKLE FREE</b> .
⑫ <b>Add a Garment</b>	Press to interrupt the wash part of the cycle to add or remove a garment.
⑬ <b>Start/Pause</b>	Press to start or pause the selected wash cycle.

## CONTROL PANEL

### WH8560P2, WH8060P2 and WH7560P models

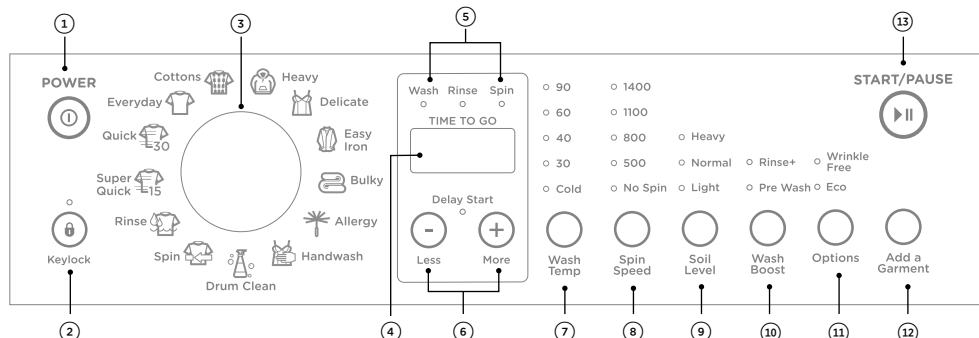

①	<b>Power</b>	Press to turn the washer ON/OFF.
②	<b>Keylock</b>	Press to disable all buttons on the control panel, except the <b>POWER</b> button. This prevents accidental button presses.
③	<b>SmartTouch™ Control Dial</b>	Rotate to select your desired wash cycle. <ul style="list-style-type: none"> <li>Red LED illuminates to indicate the selected wash cycle.</li> </ul>
④	<b>Digital display screen</b>	Shows the following: <ul style="list-style-type: none"> <li><b>TIME TO GO</b> - the remaining time in the cycle that is currently running.</li> <li>Delayed start time of wash cycle.</li> <li>Notifications if an error is detected or a warning is necessary.</li> </ul>
⑤	<b>Progress lights</b>	Indicate the current status of the wash cycle. <ul style="list-style-type: none"> <li>All lights are illuminated at the start of the wash cycle.</li> <li>The light of the current status flashes, and then turns off once completed.</li> </ul>
⑥	<b>Delay Start Less/More</b>	Press <b>MORE +</b> to increase and <b>LESS -</b> to decrease the delay start time.
⑦	<b>Wash Temp</b>	Press to increase or decrease wash water temperature.
⑧	<b>Spin Speed</b>	Press to increase or decrease spin speed.
⑨	<b>Soil Level</b>	Press to select the level of soil in your load.
⑩	<b>Wash Boost</b>	Press to select <b>PRE WASH</b> or <b>RINSE+</b> .
⑪	<b>Options</b>	Press to select <b>ECO</b> and/or <b>WRINKLE FREE</b> .
⑫	<b>Add a Garment</b>	Press to interrupt the wash part of the cycle to add or remove a garment.
⑬	<b>Start/Pause</b>	Press to start or pause the selected wash cycle.

## CONTROL PANEL

### WH1060J, WH9060J, WH8560J, WH8060J and WH7560J models

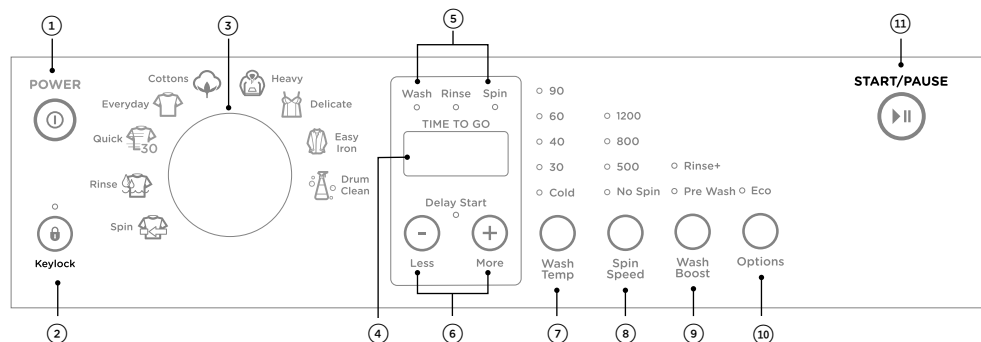













① <b>Power</b>	Press to turn the washer ON/OFF.
② <b>Keylock</b>	Press to disable all buttons on the control panel, except the <b>POWER</b> button. This prevents accidental button presses.
③ <b>SmartTouch™ Control Dial</b>	Rotate to select your desired wash cycle. <ul style="list-style-type: none"> <li>Red LED illuminates to indicate the selected wash cycle.</li> </ul>
④ <b>Digital display screen</b>	Shows the following: <ul style="list-style-type: none"> <li><b>TIME TO GO</b> - the remaining time in the cycle that is currently running.</li> <li>Delayed start time of wash cycle.</li> <li>Notifications if an error is detected or a warning is necessary.</li> </ul>
⑤ <b>Progress lights</b>	Indicate the current status of the wash cycle. <ul style="list-style-type: none"> <li>All lights are illuminated at the start of the wash cycle.</li> <li>The light of the current status flashes, and then turns off once completed.</li> </ul>
⑥ <b>Delay Start Less/More</b>	Press <b>MORE +</b> to increase and <b>LESS-</b> to decrease the delay start time.
⑦ <b>Wash Temp</b>	Press to increase or decrease wash water temperature.
⑧ <b>Spin Speed</b>	Press to increase or decrease spin speed.
⑨ <b>Wash Boost</b>	Press to select <b>PRE WASH</b> or <b>RINSE+</b> .
⑩ <b>Options</b>	Press to select <b>ECO</b> .
⑪ <b>Start/Pause</b>	Press to start or pause the selected wash cycle.

## WASH CYCLES

### WH8560F and WH8060F models

Your washer has a number of wash cycles to suit your laundering needs. Selecting the most appropriate cycle for each particular wash load will help ensure you get the best wash result.

CYCLE	DESIGNED FOR	MAX. LOAD SIZE (KG)**	WASH TEMP. (°C)	SPIN SPEED (RPM)
 <b>Cottons*</b>	A comprehensive cycle specifically for normally soiled cotton garments	8.0/8.5	40 (Cold-90)	1400 (0-1400)
 <b>Everyday</b>	A faster cycle designed for mixed loads with normal soil level	8.0/8.5	40 (Cold-90)	1400 (0-1400)
 <b>Heavy</b>	A longer, hotter wash for heavy soiled durable garments	8.0/8.5	60 (Cold-90)	1400 (0-1400)
 <b>Delicate</b>	A gentle wash with more water to care for lightly soiled delicate garments	4.0	40 (Cold-60)	500 (0-800)
 <b>Easy Iron</b>	A cycle for normally soiled garments with lower spin speeds to reduce ironing	4.0	40 (Cold-60)	800 (0-800)
 <b>Bulky</b>	A warm gentle wash and slow spin for special care of bulky items	4.0	60 (Cold-90)	800 (0-800)
 <b>Allergy</b>	Longer, hotter wash with an extra rinse to remove allergens and detergent	8.0/8.5	60 (Cold-90)	1400 (0-1400)
 <b>Wool***</b>	An extra gentle wash action for machine washable woollen items	2.0	40 (Cold-40)	800 (0-800)
 <b>Super Quick</b>	Freshening up of new or very lightly soiled garments	2.0	30 (Cold-60)	800 (0-1400)
 <b>Sports</b>	Specialised cycle with gradual heating for sportswear cleaning	4.0	40 (Cold-40)	1100 (0-1400)
 <b>Rinse</b>	Items that require rinsing and spinning	8.0/8.5	Cold	1400
 <b>Spin</b>	Spinning wet items	8.0/8.5	n/a	1400 (500-1400)
 <b>Drum Clean</b>	An extra hot cycle designed to clean your washer	n/a	90	1400

\*COTTONS', '40°C', '1400 rpm', ECO RINSE selected is the recommended water and energy saving cycle for normally soiled, everyday washing

\*\*Depends on model

### \*\*\*Woolmark Apparel Care













The wool wash cycle of this machine has been approved by The Woolmark Company for the washing of machine washable wool products provided that the products are washed according to the instructions on the garment label and those issued by the manufacturer of these washing machines M1528. Only the WH1060P, WH9060P, WH8560F and WH8060F models comply with Woolmark Apparel Care requirements.



## WASH CYCLES

### WH1060P, WH9060P, WH8560P3 and WH8060P3 models

Your washer has a number of wash cycles to suit your laundering needs. Selecting the most appropriate cycle for each particular wash load will help ensure you get the best wash result.

CYCLE	DESIGNED FOR	MAX. LOAD SIZE (KG)**	WASH TEMP. (°C)	SPIN SPEED (RPM)
 <b>Cottons*</b>	A comprehensive cycle specifically for normally soiled cotton garments	8.0/8.5 9.0/10.0	40 (Cold-90)	1400 (0-1400)
 <b>Everyday</b>	A faster cycle designed for mixed loads with normal soil level	8.0/8.5 9.0/10.0	30 (Cold-60)	1100 (0-1400)
 <b>Heavy</b>	A longer, hotter wash for heavy soiled durable garments	8.0/8.5 9.0/10.0	60 (Cold-90)	1100 (0-1400)
 <b>Delicate</b>	A gentle wash with more water to care for lightly soiled delicate garments	4.0	30 (Cold-40)	500 (0-800)
 <b>Easy Iron</b>	A cycle for normally soiled garments with lower spin speeds to reduce ironing	4.0	30 (Cold-60)	800 (0-800)
 <b>Bulky</b>	A warm gentle wash and slow spin for special care of bulky items	4.0	40 (Cold-90)	800 (0-800)
 <b>Steam Refresh</b>	A quick cycle for de-wrinkling and removing light odours	2 items	n/a	n/a
 <b>Wool***</b>	An extra gentle wash action for machine washable woollen items	2.0	40 (Cold-40)	800 (0-800)
 <b>Quick 30</b>	Cleaning lightly soiled loads quickly	4.0	30 (Cold-30)	800 (0-1400)
 <b>Quick 15</b>	Freshening up of new or very lightly soiled garments	2.0	30 (Cold-30)	800 (0-1400)
 <b>Rinse</b>	Items that require rinsing and spinning	8.0/8.5 9.0/10.0	Cold	1100 (0-1400)
 <b>Spin</b>	Spinning wet items	8.0/8.5 9.0/10.0	n/a	1100 (500-1400)
 <b>Drum Clean</b>	An extra hot cycle designed to clean your washer	n/a	90	1400

\*COTTONS', '40°C', '1400 rpm', ECO selected is the recommended water and energy saving cycle for normally soiled, everyday washing

\*\*Depends on model

### \*\*\*Woolmark Apparel Care

The wool wash cycle of this machine has been approved by The Woolmark Company for the washing of machine washable wool products provided that the products are washed according to the instructions on the garment label and those issued by the manufacturer of these washing machines M1528.













Only the WH1060P, WH9060P, WH8560F, WH8060F, WH8560P3 and WH8060P3 models comply with Woolmark Apparel Care requirements.



## WASH CYCLES

### WH8560P2, WH8060P2 and WH7560P models

Your washer has a number of wash cycles to suit your laundering needs. Selecting the most appropriate cycle for each particular wash load will help ensure you get the best wash result.

CYCLE	DESIGNED FOR	MAX. LOAD SIZE (KG)**	WASH TEMP. (°C)	SPIN SPEED (RPM)
 <b>Cottons*</b>	A comprehensive cycle specifically for normally soiled cotton garments	7.5/8.0/8.5	40 (Cold-90)	1400 (0-1400)
 <b>Everyday</b>	A faster cycle designed for mixed loads with normal soil level	7.5/8.0/8.5	40 (Cold-90)	1400 (0-1400)
 <b>Heavy</b>	A longer, hotter wash for heavy soiled durable garments	7.5/8.0/8.5	60 (Cold-90)	1400 (0-1400)
 <b>Delicate</b>	A gentle wash with more water to care for lightly soiled delicate garments	4.0	40 (Cold-60)	500 (0-800)
 <b>Easy Iron</b>	A cycle for normally soiled garments with lower spin speeds to reduce ironing	4.0	40 (Cold-60)	800 (0-800)
 <b>Bulky</b>	A warm gentle wash and slow spin for special care of bulky items	4.0	60 (Cold-90)	800 (0-800)
 <b>Allergy</b>	Longer, hotter wash with an extra rinse to remove allergens and detergent	7.5/8.0/8.5	60 (Cold-90)	1400 (0-1400)
 <b>Handwash</b>	A very gentle wash for extra special items	2.0	30 (Cold-40)	500 (0-500)
 <b>Quick</b>	Cleaning lightly soiled loads quickly	4.0	40 (Cold-60)	800 (0-1400)
 <b>Super Quick</b>	Freshening up of new or very lightly soiled garments	2.0	30 (Cold-60)	800 (0-1400)
 <b>Rinse</b>	Items that require rinsing and spinning	7.5/8.0/8.5	Cold	1400 (0-1400)
 <b>Spin</b>	Spinning wet items	7.5/8.0/8.5	n/a	1400 (500-1400)
 <b>Drum Clean</b>	An extra hot cycle designed to clean your washer	n/a	90	1400

\*COTTONS', '40°C', '1400 rpm', with ECO selected is the recommended water and energy saving cycle for normally soiled, everyday washing









\*\*Depends on model



## WASH CYCLES

### WH9060J, WH8560J, WH8060J and WH7560J models

Your washer has a number of wash cycles to suit your laundering needs. Selecting the most appropriate cycle for each particular wash load will help ensure you get the best wash result.

CYCLE	DESIGNED FOR	MAX. LOAD SIZE (KG)**	WASH TEMP. (°C)	SPIN SPEED (RPM)
 <b>Cottons*</b>	A comprehensive cycle specifically for normally soiled cotton garments	7.5/8.0 8.5/9.0	40 (Cold-90)	1200 (0-1200)
 <b>Everyday</b>	A faster cycle designed for mixed loads with normal soil level	7.5/8.0 8.5/9.0	40 (Cold-90)	1200 (0-1200)
 <b>Heavy</b>	A longer, hotter wash for heavy soiled durable garments	7.5/8.0 8.5/9.0	60 (Cold-90)	1200 (0-1200)
 <b>Delicate</b>	A gentle wash with more water to care for lightly soiled delicate garments	4.0	40 (Cold-60)	500 (0-800)
 <b>Easy Iron</b>	A cycle for normally soiled garments with lower spin speeds to reduce ironing	4.0	40 (Cold-60)	800 (0-800)
 <b>Quick</b>	Cleaning lightly soiled loads quickly	4.0	40 (Cold-60)	800 (0-800)
 <b>Rinse</b>	Items that require rinsing and spinning	7.5/8.0 8.5/9.0	Cold	1200 (0-1200)
 <b>Spin</b>	Spinning wet items	7.5/8.0 8.5/9.0	n/a	1200 (500-1200)
 <b>Drum Clean</b>	An extra hot cycle designed to clean your washer	n/a	90	1200









\*'COTTONS', '40°C', '1200 rpm', with **ECO** selected is the recommended water and energy saving cycle for normally soiled, everyday washing

\*\*Depends on model

## WASH CYCLES

### WH1060J

Your washer has a number of wash cycles to suit your laundering needs. Selecting the most appropriate cycle for each particular wash load will help ensure you get the best wash result.

CYCLE	DESIGNED FOR	MAX. LOAD SIZE (KG)	WASH TEMP. (°C)	SPIN SPEED (RPM)
 <b>Cottons*</b>	A comprehensive cycle specifically for normally soiled cotton garments	10.0	40 (Cold-90)	1200 (0-1200)
 <b>Everyday</b>	A faster cycle designed for mixed loads with normal soil level	10.0	30 (Cold-60)	1200 (0-1200)
 <b>Heavy</b>	A longer, hotter wash for heavy soiled durable garments	10.0	60 (Cold-90)	1200 (0-1200)
 <b>Delicate</b>	A gentle wash with more water to care for lightly soiled delicate garments	4.0	30 (Cold-40)	500 (0-800)
 <b>Easy Iron</b>	A cycle for normally soiled garments with lower spin speeds to reduce ironing	4.0	30 (Cold-60)	800 (0-800)
 <b>Quick</b>	Cleaning of slightly soiled loads quickly	4.0	30 (Cold-30)	800 (0-1400)
 <b>Rinse</b>	Items that require rinsing and spinning	10.0	Cold	1200 (0-1200)
 <b>Spin</b>	Spinning wet items	10.0	n/a	1200 (500-1200)
 <b>Drum Clean</b>	An extra hot cycle designed to clean your washer	n/a	90	1200

\*COTTONS', '40°C', '1200 rpm', with ECO selected is the recommended water and energy saving cycle for normally soiled, everyday washing

## DETERGENT AND SOFTENER

---

### Detergent type

Your washer requires low-sudsing detergent to prevent oversudsing problems. Low sudsing detergent comes in powder, liquid or pod form and is labelled front loading, low suds, high efficiency or HE. Using top loader detergent in your front loader washer may lead to excessive suds formation, which will lengthen the cycle time as the washer waits for the suds to dissolve.

- If using liquid detergent ensure the liquid detergent compartment is installed.
- If using powder ensure the liquid detergent compartment has been removed.
- Ensure the detergent drawer is completely closed before starting the cycle.

### How much detergent?

Follow the instructions on the back of the detergent packet or bottle as a guide to the correct amount of detergent to use. The correct amount of detergent will vary, depending on level of soiling and size of load. Jeans and work clothes may need more detergent, while towels usually need less. The larger your load, the more detergent you may have to add.

### Detergent advice

Add the detergent BEFORE starting the cycle, close the dispenser and do not open it while the cycle is running. If you find foam leaking from your washer, check you are using a low sudsing or front loader type detergent and check the quantity you are using against the detergent manufacturers recommendation. You may need to reduce the amount you are using.

### Fabric softener

Add fabric softener to the middle compartment of the dispenser marked with a . Fabric softener should not be used if you have selected the **STEAM REFRESH** or any **QUICK** cycle. The washer will automatically flush the fabric softener during the rinse part of the cycle.

If you wish to use fabric softener we recommend to:

- Use it sparingly. Measure it carefully and do not use more than 25ml (1/2 cap), some thicker varieties may need diluting.
- Clean your dispenser regularly.
- Clean your washer regularly using the **DRUM CLEAN** cycle.
- Complete wash cycles at a wash temperature of 40°C or above at regular intervals (eg every fifth wash) as washing in cold water increases the chance of scrud occurring (see below).
- If you fill beyond the MAX mark, the fabric softener will be dispensed into the drum prematurely and contribute to scrud.

### Scrud

Scrud is the name of the waxy build-up that can occur within any washer when fabric softener comes in contact with detergent. This build-up is not brought about by a fault in the washer. If scrud is allowed to build up in the washer it can result in stains on clothes and an unpleasant smell in your washer. If you wash a particularly dirty load, we recommend putting the washer through a **RINSE** cycle once the cycle has finished and the load has been removed, to clean out any residue from that cycle.

## WHERE TO PUT THE DETERGENT

### Pods

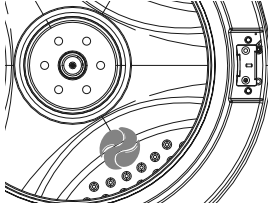

Detergent pods are a no mess alternative to powdered or liquid detergent. They must be placed at the back of the drum prior to loading your clothes. This will ensure they are activated quickly in the wash. Do not place pods in the detergent dispenser drawer or on top of your clothes.

### Pre Wash

When you select **PRE WASH**, the pre wash compartment is flushed at the start of the cycle. For more information refer to 'Wash cycle options'. **PRE WASH** will not be available if the **ECO/ECO RINSE** option has been selected.

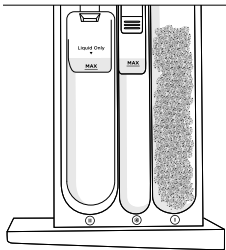

If you wish to use the **PRE WASH** option, liquid or powdered detergent only must be placed in the pre wash detergent compartment on the right side of the drawer, marked with a ①.

### F/P Model Washers

#### Liquid detergent

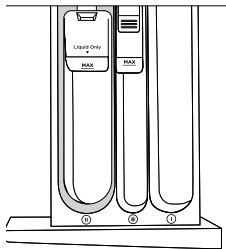

Detergent is added to the main wash compartment on the left side of the dispenser drawer marked with a ②.

As the washer fills, water is flushed into this compartment and is mixed with the detergent, the detergent solution is then delivered into the drum. There may be a small volume of water left in the liquid detergent dispenser at the end of the cycle. This is normal.

## WHERE TO PUT THE DETERGENT

### Powdered detergent

If you wish to use powdered detergent, the liquid detergent compartment **MUST** be removed from the dispenser drawer.

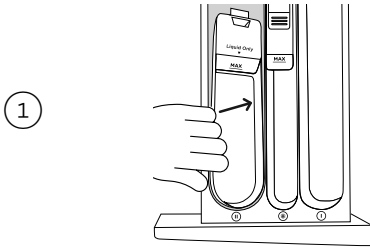

To remove the liquid detergent compartment, firmly grasp and twist the left hand side of the internal compartment and pull upwards.

### To replace the liquid detergent compartment

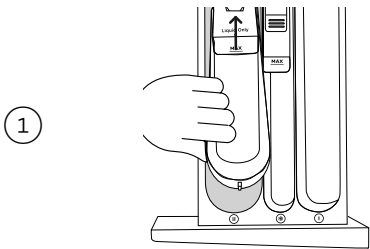

Slide it back into the drawer marked ①.

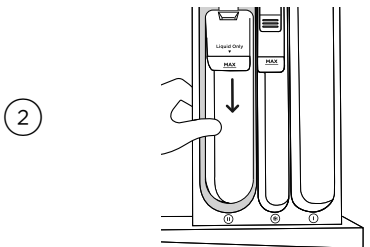

Press down in the middle until it clicks back into place.

## WHERE TO PUT THE DETERGENT

---

### J Model Washers

#### Powdered or liquid detergent

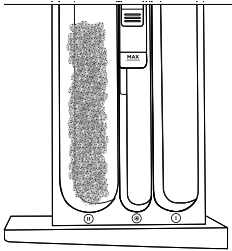

Detergent is added to the main wash detergent compartment on the left side of the dispensing drawer marked with a (II).

- As the washer fills, water is flushed through this compartment to deliver a detergent solution into the drum.
- If you select the **PRE WASH** option, you must use a powdered detergent in the main wash detergent compartment.

If using **DELAY START** we recommend using powdered detergent for the main wash.

## WASH PREPARATION

### Sorting

Sort items according to colour, fabric type, and soil type. Wash fine, delicate fabrics separately from thick, heavy fabrics. Always separate coloured items from whites, especially when they are new. Colour run could be an issue if you wash items at higher temperatures. Some soils, like mud and blood are best washed in cold water. Oily soils (eg some foods and marks on shirt collars) are best washed in warm water. The care label will advise on how the garment should be washed.

ITEMS/WASH REQUIREMENTS	SUGGESTED CYCLE AND OPTIONS*	SUGGESTED TEMPERATURE
Towels, sheets, pillowcases	Everyday, 1400 or 1100/1200 rpm	30°C or 40°C
Bulky items - doonas, duvets, sleeping bags	Bulky	30°C or 40°C
Shirts, pants, other creasables	Easy Iron or Steam Refresh, 800 rpm	30°C or 40°C
Woollens, silks	Wool, Handwash, 500 rpm	30°C or 40°C
Delicates, fine fabrics	Delicate, Wool or Handwash	30°C
Jeans	Everyday or Heavy	Cold or 30°C
Highly coloured items	Everyday	Cold or 30°C
Whites, cotton items	Cottons, 1100/1200 or 1400 rpm	40°C or 60°C
Sensitive skin or extra rinsing	Allergy, Cottons, Rinse+, 1400 rpm	40°C
Asthma/allergies	Allergy, Cottons, Rinse+	60°C
Lightly soiled items	Quick, Super Quick, Speed, Timesaver	30°C
Muddy, sandy or linty items	Everyday with Pre Wash and Rinse+	Cold
Unpleasant odour in washer	Drum Clean	90°C

\*Cycles and spin speeds available will depend on your washer model

### Before you load

- Check pockets for items that could damage your clothes or get caught in the washer.
- Close zippers, hooks and eyes, and other fastenings (ie fasten the opening of duvet/ doona covers), and remove loose bra wires. All these can damage both your washer and your clothes.
- Place delicate items, such as lingerie, in a mesh laundry bag before placing in the washer.
- Pre-treat any stains, taking care not to spray pre-treaters on your washer as they can cause damage to the plastic surfaces.

### Loading

Your washer will be more efficient when washing larger loads, so try to collect enough items to loosely fill the drum when the items are dry.

## GETTING STARTED QUICKLY

1

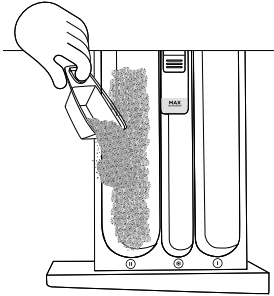

Open the detergent drawer.

Pour liquid or powder detergent in the draw or place the pod in the drum.

Pre-dissolving detergent in warm water when washing can improve the performance of the liquid and powder detergent.

2



Press 1 to activate your washer.

3



Select your desired wash cycle by turning the Control Dial. The wash cycle icons will illuminate as you turn the dial showing which cycle is selected, along with the default wash cycle settings.

4

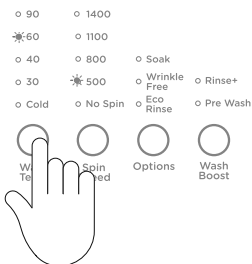

Customise your wash as needed by selecting specific temperature and spin speeds. Refer to 'Wash cycle options' for more information.



## GETTING STARTED QUICKLY

---

5



Press ►|| to start the cycle. The washer will start to fill with water and select the correct wash action for your load.

6



Use  to lock the buttons on the control panel, preventing them from being activated accidentally by a washing basket or little fingers, refer to the 'Wash cycle options' section.

For best fabric and colour care, remove your clothes as soon as the cycle has finished. Failure to follow the advice in this guide may result in damage to your garments and your expectations of wash performance may not be met.

## WASH CYCLE OPTIONS

Once you have selected your wash cycle you may wish to change the default wash options.

### Wash cycle options

All wash cycles default to the recommended options for that cycle based on the average expected load to be washed. You can vary the options (eg **WASH TEMP**, **SPIN SPEED**) to create your desired cycle. Some options are not available on some cycles, for clothes care reasons, or because the option is not appropriate for the cycle.

### To change a wash option or options you have selected after a cycle has started

1



Press ►|| and select your new setting(s), then press ►|| again to resume the cycle with the new setting(s).

### Wash Temp

Your washer offers these wash temperatures:

COLD TAP	CONTROLLED COLD	WARM/COLD	WARM	HOT	EXTRA HOT
Incoming water from tap	20°C	30°C	40°C	60°C	90°C

Simply press the **WASH TEMP** button to increase or decrease the wash temperature. Some temperatures are not available on some cycles as a safeguard for your clothes (eg temperatures above 40°C on the **DELICATE** cycle).

The washer will fill with both hot and cold water (if possible) to achieve the selected wash temperature. If required, ie for cold supply or cold connection only, the washer will heat the water to the selected temperature.

If you do not wish to heat the water to 20°C using the internal heater, refer to the 'Changing pre-set options' section for detail on how to set **COLD TAP** as the default temperature for your cold water wash.

## WASH CYCLE OPTIONS

### Spin Speed

Your washer offers multiple spin speeds. To best care for your load, to select the speed you want, press the SPIN SPEED button repeatedly until the desired spin speed illuminates.

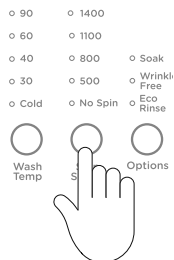

Model	RPM	RPM	RPM	RPM	NO SPIN
F/P	500	800	1100	1400	Y
J	500	800	1200	n/a	Y

### No Spin

Selecting **NO SPIN** will end the cycle after the rinse, allowing you to remove items you wish to drip dry.

The washer will complete the default wash and rinse spins for the cycle; only the final spin will not be completed. Remove the items you wish to drip dry and then select **SPIN** and a **SPIN SPEED** to spin out the remaining items.

### Time Saver (WH8560F and WH8060F models)

Your washer offers a **TIME SAVER** feature that, when selected, adjusts the cycle programming, by combining special temperature profiling and a unique tumble sequence. The result – excellent wash performance combined with time savings.

This option can be selected on the **EVERYDAY, COTTONS, HEAVY, EASY IRON, ALLERGY** and **SPORTS** cycles.

A number of factors can influence the amount of time saved on a cycle, including the load size, cycle chosen, water flow rate and load distribution during spin.

### Optimise Wash (WH1060P, WH9060P, WH8560P3 and WH8060P3 models)

Your washer offers you two optimise wash options – **SPEED** and **ECO** – allowing you to save time, or water and energy.

### Speed

A special feature designed to offer a shorter cycle whilst providing good wash performance. This option can be selected on the **COTTONS, HEAVY** and **EASY IRON** cycles.

### Eco

Use the **ECO** option to save water and energy. Selecting **ECO** will reduce the wash temperature slightly and alter the wash and rinse programming.

This option can be selected on the **EVERYDAY, COTTONS, HEAVY, EASY IRON** and **BULKY** cycles.

- **SPEED** and **ECO** cannot be selected together.
- **ECO** will not be available if **PRE WASH** or **RINSE+** has been selected.

## WASH CYCLE OPTIONS

---

### Soil Level (WH8560P2, WH8060P2 and WH7560P models)

The **SOIL LEVEL** option lets you adjust the wash to suit the amount of soil in your load. For example, select **HEAVY** for dirty clothes; select **LIGHT** for items that are only lightly soiled. This adjusts the wash time accordingly to give the load the right amount of agitation to remove the soil.

### Wash Boost

#### Pre wash (all models)

For extra dirty loads you can perform a **PRE WASH**. Your washer will start the wash with a short wash in cool water to remove excess soil. After this the washer will drain and then fill at the selected temperature for the main wash.

Simply press the **WASH BOOST** button and select **PRE WASH** when choosing your wash options. **PRE WASH** cannot be selected after a wash cycle has been started.

If you use the **PRE WASH** option, liquid or powdered detergent needs to be placed in the correct detergent compartment. The pre wash compartment is on the right hand side of the drawer, marked ①. When you select **PRE WASH**, the compartment is flushed at the start of the cycle.

**PRE WASH** will not be available if the **ECO/ECO RINSE** option has been selected.

#### Rinse+ (all models)

If you have a particularly dirty load, or you have sensitive skin and wish to give your clothes an extra rinse, select **RINSE+** from the **WASH BOOST** options. Your load will undergo an extra rinse to get rid of any residual detergent or soil in the items.

**RINSE+** will not be available if the **ECO/ECO RINSE** option has been selected.

#### Wash+ (WH1060P, WH9060P, WH8560P3 and WH8060P3 models)

**WASH+** allows you to increase the wash time for heavy soiled items. The increase in wash time gives the load the right amount of tumbling to remove the soil from items that might need it.

# WASH CYCLE OPTIONS

## Options

### Soak (WH8560F and WH8060F models only)

The **SOAK** option provides a two-hour soak during the middle of the wash phase of the cycle. The washer will then complete the rest of the cycle. During **SOAK**, the washer will agitate for a few seconds every minute.

**SOAK** is not available on **WOOL**, **DRUM CLEAN**, or **SUPER QUICK** cycles.

If the **SOAK** option is selected on a **QUICK** cycle, the soak time will be one hour only.

**Ensure items are colourfast before using soak.**

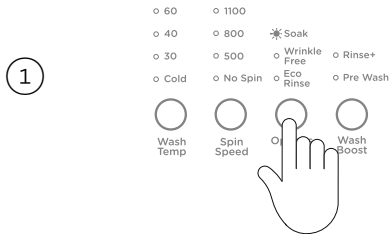

Select **SOAK** from the **OPTIONS** menu.



To exit **SOAK** early, press ►|| and turn the dial to select **RINSE**. Change the **SPIN SPEED** if necessary (eg select **500** if washing delicate or creasable items) and press ►||.

Do not use your washer to soak items in bleach or sanitiser and if you've soaked items in a bucket, do not tip the contents of the bucket into your washer. The chemicals in these products are very corrosive to metal surfaces and can damage your washer. Rinse and wring items out thoroughly before placing them in your washer.

### Wrinkle Free (F/P models)

We recommend you remove the clothes from the washer immediately after the completion of the cycle to minimise wrinkling and creasing of items and to prevent dye run. However, if you will not be present at the end of the wash you can select **WRINKLE FREE**.

When **WRINKLE FREE** is selected, the washer will tumble the clothes once every 15 minutes for up to 12 hours after the cycle has finished. The **WRINKLE FREE** light and ►|| button will flash, and the washer will beep at regular intervals to remind you to remove your load. To remove the load during this phase, simply press the ►|| button.

## WASH CYCLE OPTIONS

---

### Eco/Eco Rinse

Use the **ECO/ECO RINSE** option to save water and energy. Selecting **ECO/ECO RINSE** will reduce the wash temperature slightly and alter the wash and rinse programming.

This option will not be available if **PRE WASH** or **RINSE+** has been selected.

If you wish to, you can select both the **PRE WASH** and **RINSE+ WASH BOOST** options to perform on the same cycle. Likewise, you can select **ECO/ECO RINSE** and **WRINKLE FREE** to perform on the same cycle. Press the appropriate button until both options are selected. Repeat to deselect an option.

### Add a Garment (F/P models)

The **ADD A GARMENT** option enables you to add or remove items during the wash stage of the cycle, under certain conditions.

1



Press the **ADD A GARMENT** button.

Wait until you hear the door unlock. The ►|| button will flash.

2



Open the door and add or remove items. Close the door and press ►|| to restart the cycle.

## WASH CYCLE OPTIONS

### Keylock

KEYLOCK can be used to lock the buttons on your washer. This will avoid accidental button pushes during the wash cycle.

To turn KEYLOCK on or off when the washer is powered on:

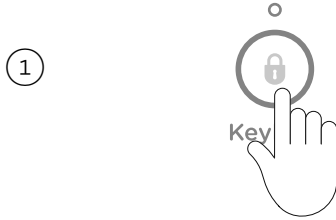



Press  for three seconds.

When activated, the light above the  button is illuminated.

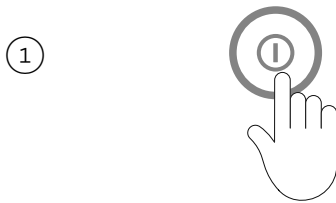
To turn your washer on if KEYLOCK is on and the washer is powered off:





Press the  button, then press and hold  for three seconds. This will activate the control panel. Wash cycles and options can now be selected.

If a button is pressed while KEYLOCK is activated, the LED above KEYLOCK will flash.

If KEYLOCK is on and you want to pause your washer:



To pause your washer at any time during the cycle, press and hold  for three seconds then press .

If KEYLOCK is on and you want to power off your washer at any time:

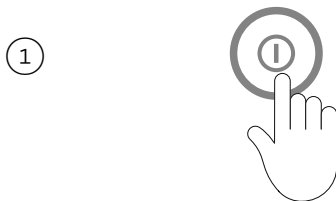

Press .

## WASH CYCLE OPTIONS

### Delay Start

The **DELAY START** option can delay the start of the wash cycle between five minutes and 12 hours. This can be useful to time your washing to finish when you arrive home from work, or to start once you have finished in the shower.

①

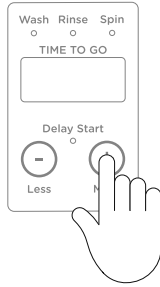

Press the **MORE +** button to increase the delay time, and **LESS -** button to decrease the time, or turn **DELAY START** off.

②



Press **▶||** to confirm your selection and start the countdown. The display screen will show the time until the cycle is set to begin.

Avoid using **DELAY START** for damp, non-colourfast items as this may cause dye run to occur.

### Washing bulky items

The **BULKY** cycle takes special care of bulky items. Bulky garments and bedding wash most effectively when they can move freely. Ensure that there is sufficient room in the drum for the load to move during the wash.

When washing a single bulky item add a large beach towel to the wash, to ensure the load is balanced for an effective spin.

### Washing woollens

Many woollen items carry a machine washable care claim. The fibres of these woollens have been treated to prevent felting when they are machine washed.

- Check the care label.
- Use a wool detergent.
- Use the specially designed **WOOL** cycle.
- To dry woollens lie them flat on a towel and pat into shape. Dry out of direct sunlight.

Most handcrafted garments are not made of machine washable wool and we recommend that you wash them by hand only. Hand washed woollens may be spun in your washer (select **SPIN SPEED, 500**).

Washing underlays and sheepskins is not recommended because they could produce excessive amounts of lint that may cause pump blockages.



# CUSTOMISING A WASH CYCLE

## To customise a cycle

You can program your washer to remember the wash options you prefer for each wash cycle. For instance, you may want to set the **EVERYDAY** cycle to default to a **COLD** wash or set **HEAVY** cycle to include a **SOAK**.

1



Press 1 to activate your washer.

2



Turn the dial to select the wash cycle you wish to customise, eg **EVERYDAY**.

3



Press and hold the button of the option you want to customise, eg **WASH TEMP** for three seconds. You will hear two quick beeps and the wash cycle icon will flash. The screen will display **SEL**.

4

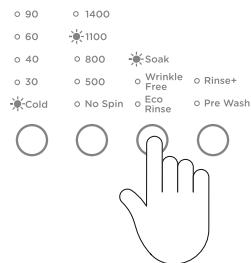

Continue to select any other options you wish to customise for this cycle.

## CUSTOMISING A WASH CYCLE

---

5



Press **⏸** to store your customised cycle.  
A long beep will sound to confirm that your changes have been saved.

To change your customised wash cycle simply repeat these steps.

## CHANGING PRE-SET OPTIONS

### Option adjustment mode (Models WH1060P, WH9060P, WH8560P3 and WH8060P3)

This allows you to change the **CONTROLLED COLD** default setting wash temperature to **COLD TAP**. If your incoming cold water temperature is very low and you choose to do a **COLD TAP** wash, the wash may be less effective.

#### To enter Option Adjustment mode:

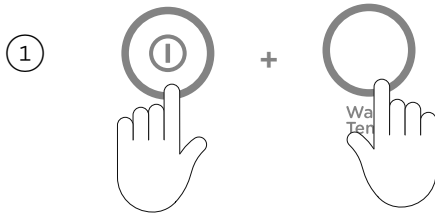

Turn your washer on at the wall but do not press **I**.

Press and hold the **I** and **WASH TEMP** buttons together for three seconds. You will hear a quick beep and **SET** will appear on the screen indicating you have entered option adjustment mode.

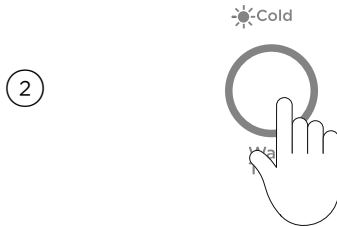

The cold **WASH TEMP** icon will flash on and off. This is the default setting, where the machine uses the internal heater to heat the water to 20°C.

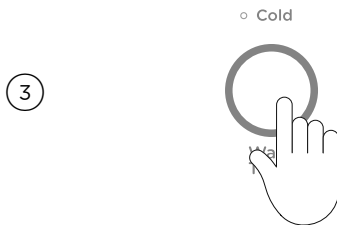

Press the **WASH TEMP** button once, the cold icon will stop flashing, indicating that the temperature of the water will now be the same as the incoming water from the cold supply.

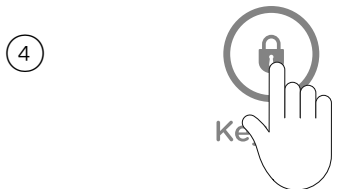

Press **Ke** to save the setting.

Your washer will automatically remember your changes for all future washes you do on this cycle.

If you always use **COLD** or **CONTROLLED COLD** water, we recommend that a warm or hot wash be used regularly, eg every fifth wash should be at least 40°C or above. Warm water is needed to help maintain the cleanliness of your washer.

# CHANGING PRE-SET OPTIONS

## Factory reset

You can reset your washer to factory default settings by following the steps below.

To reset your washer to factory default settings:



Select the **SPIN** cycle.

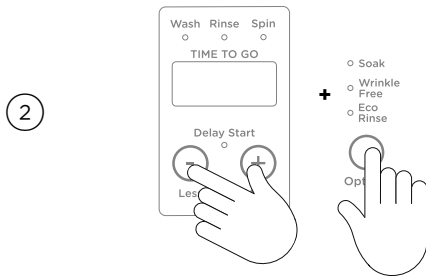

Press **MORE +**, **LESS -** and **OPTIONS** buttons together for three seconds, *dEF* will appear on the screen and the washer will beep.

Your washer will now be reset to factory default settings.

## CARING FOR YOUR WASHER

---

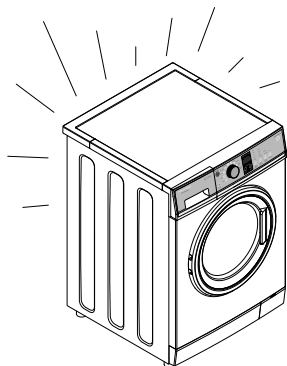

### **When you have finished using your washer**

- Turn off the taps to prevent the chance of flooding should a hose burst.
- Unplug the washer from the power socket.

### **Cleaning your washer**

Before you start cleaning your washer, ensure that it is disconnected from the power (ie unplug the washer from the power socket).

### **Cleaning the control panel and outer surfaces of the washer**

Use a soft damp cloth to wipe all surfaces, and wipe dry. Avoid using chemical or scouring cleaners, as these will damage the paint and plastic surfaces of your washer.

### **Cleaning the detergent dispenser drawer**

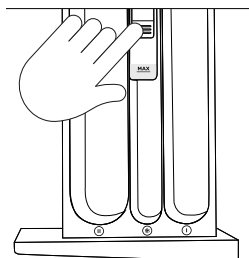

- ① To remove the drawer, pull it open, push down on the tab in the fabric softener compartment and pull out.
- ② Wipe out the detergent dispenser drawer with a damp cloth.
- ③ Rinse it under warm water and re-insert.

Clean the drawer regularly, especially if you use fabric softener.

## CARING FOR YOUR WASHER

### Cleaning the inside of your washer

It is important that you regularly clean the inside of your washer using the **DRUM CLEAN** cycle. After 100 cycles  will flash every time you turn your washer on to remind you to do this. If your washer starts to smell this is a sign that you should complete a **DRUM CLEAN** cycle. We recommend that you do not have any items in the washer when you run this cycle.

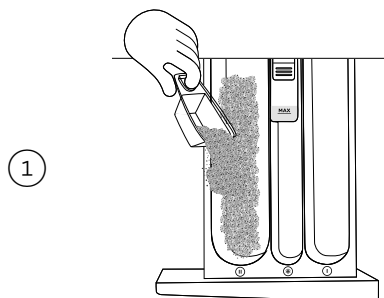

Add the washing machine cleaner directly into the main wash detergent compartment of the dispenser drawer. Follow manufacturers' instructions.



Press ① to turn your washer on and select the **DRUM CLEAN** cycle.



Press ▶|| to start the cycle.

## CARING FOR YOUR WASHER

---

Aside from the detergent dispenser, water hose(s), and the pump filter, no other parts are designed to be removed from the washer for cleaning. Do not attempt to remove any other part of the washer.

### Cleaning the drum and the door

- Use a soft damp cloth to wipe the door, cleaning any water marks or residue off it.
- Wipe the rubber seal around the door. Remove any items or lint accumulating in the bottom of the seal catchment and wipe out any water accumulated here. If this is not cleaned out, unpleasant odours will develop.
- If the drum has any residual dirt or lint stuck to it, remove this and wipe the drum clean. Do not leave any metal objects in the drum as these may rust and cause staining.
- WH8560F and WH8060F models also have a self cleaning door flush that directs a portion of the rinse water over the door during various stages of the cycle to help to clean hair and insolubles from the inside of the door and surrounding parts. We still recommend that you manually clean it with a soft cloth periodically as per the instructions above.

### Cleaning the hose(s)

Each hose has a filter in it, preventing any solid contaminants in the water entering your washing machine. Occasionally you should disconnect the water inlet hose(s) where they connect to the tap(s), check these for any build up of dirt and wash this out.

### Detergent advice

- If unpleasant odours are noticeable from your washer, it is possible that not enough detergent is being used for the soil level of your loads. Run a **DRUM CLEAN** cycle and either buy better quality detergent or use a higher dose. Different detergents have different cleaning chemicals. Consider alternating detergents to help remove odour.
- Add the detergent **BEFORE** starting the cycle, close the dispenser and do not open it while the cycle is running.

Leave the door to your washer open when it is not in use to allow the washer to dry out, otherwise it will develop unpleasant odours. When leaving the door open like this, it is extremely important that children and pets are kept away from the washer so they cannot be accidentally trapped inside it.

## CARING FOR YOUR WASHER

### Cleaning the pump filter

1

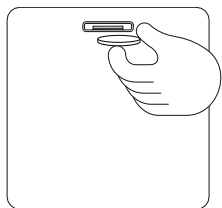

Turn the power off and unplug the washer. Use a coin to open the filter cover. Place the edge of the coin into the slot and tilt upwards whilst levering the cover open.

2

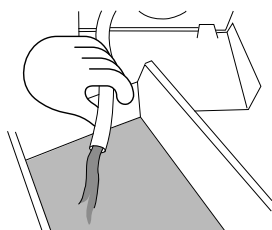

Unhook the pump outlet hose and pull it out (about 150mm). Remove the plug and allow any water (approximately 250ml) to drain into a shallow dish.

After the draining process is complete, replace the plug into the hose and refit the hose back into the housing.

3

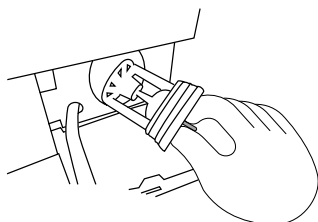

Remove the filter by turning anti-clockwise. Clean and rinse under a tap. Check the pump filter cavity for any further obstruction.

4

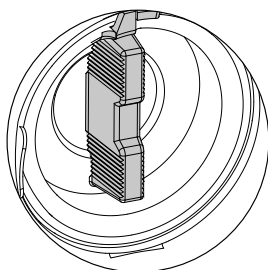

Replace the filter by turning clockwise until the turning handle stops in the vertical position, and cannot be turned further.



## CARING FOR YOUR WASHER

---

### Products that might damage your washer

- Concentrated bleaches, laundry pre-soakers/sanitiser, stain removers and hydrocarbon solvents (eg petrol and paint thinners) can cause damage to the surfaces eg control panel, and components of your washer.
- Be careful when washing garments stained with solvents as they are flammable. DO NOT put them in your dryer.
- Use of dyes in your washer may cause staining of the plastic components. The dye will not damage the washer but we suggest you thoroughly clean your washer afterwards. We do not recommend the use of dye strippers in your washer.
- Nappy sanitiser and bleach are very corrosive to metal surfaces. DO NOT tip the contents of a nappy bucket into your washer. Rinse and wring items out thoroughly before placing them in the washer.

### Moving your washer

Make sure any water in the washer is drained out. This can be done by cleaning out the pump filter, refer to 'Cleaning the pump filter'.

If you have the transit rods and you need to move your washer, replace them before moving. This will protect the internal components of your washing machine from damage.

To replace the transit bolts, pull out the white plastic covers in the back of the washer. Refer to 'Installation guide'. Push the transit bolt rubber grommets and plastic spacers into the hole and tighten with the spanner provided with the product.

### Saving water, energy and the environment

Water-efficient washing machines will save you money, but it is also worth thinking about energy use, recycling water and the environment. Some options to consider include the following:

- Turn the washer off at the wall when not in use.
- Turn off the taps when not in use.
- Select cooler wash temperatures.
- Wash full loads rather than several smaller loads.
- Use the **ECO** wash and **ECO RINSE** option/functions (where available).
- Follow instructions on the detergent packet or bottle - do not overdose.
- Use concentrated detergent - it costs less per wash.
- Consider re-using the washing machines grey water on the garden or for flushing your toilet - more information can be found on government websites promoting energy and water saving.

## BEFORE YOU CALL FOR SERVICE

### User warnings

Your washer is capable of self diagnosis and may sound a series of beeps and display a notification or warning to inform you when there is a problem. In most cases you will be able to address the problem the washer is alerting you to. Check this chart before you call for service.

PROBLEM	DISPLAYED AS	WHAT TO DO
Keylock is activated	KEY LOC	Press and hold  button for three seconds.
Pump filter is blocked	CLr FLtR	Clean the pump filter
The washer is not getting any water	no tAP	<p>Check the taps have been turned on</p> <p>If there is no hot water connection the washer will heat the water itself, but there must be a cold water connection to the cold valve.</p> <p>Check the hose connections. If the cold water supply is connected to the hot valve and there is no connection to the cold valve the washer will not fill.</p> <p>Check the inlet hose filters are not blocked, the hose(s) are not kinked and are attached correctly.</p> <p>Check that the drain hose is not too low or pushed into the standpipe too far. This will cause the water to siphon out of the washer.</p> <p>Check that the cold water temperature does not exceed the 35°C temperature requirement.</p> <p>Check the water flow rate. It maybe too low.</p>
The washer is out of balance	out OF bAL	<p>The wash load has gone out of balance at some point during the cycle. Touch ►   to stop message. If you want to improve the dryness of the load, manually re-distribute the load and remove items if necessary. Close the door and select the <b>SPIN</b> cycle on the dial, adjust the spin speed if necessary and touch ►   to start the washer.</p> <p>Check the washer is level.</p>

## BEFORE YOU CALL FOR SERVICE

PROBLEM	DISPLAYED AS	WHAT TO DO
The washer has too many suds	<i>Sud LOC</i>	<p>Washer will stop and flash <i>Sud LOC</i> while waiting for suds to dissipate. The washer will not beep during this time. When the suds have dissipated the washer will automatically restart. If a suds event has occurred during a cycle the washer will also display this warning at the end of the cycle, to alert you that this has occurred. This may help to explain any reduction in performance.</p> <hr/> <p>Check you are using a detergent suitable for front loaders.</p> <hr/> <p>Check you are not overdosing the detergent.</p> <hr/> <p>Check the standpipe height for the drain is a minimum of 600mm.</p>
Door is locked	<i>door LoCd</i>	<p>The temperature in the drum is over 60°C therefore it is not safe to open the door. Wait until the temperature drops below 60°C.</p> <hr/> <p>Check the water level in the drum. If the level is above the bottom of the door seal, the door cannot be opened. Use the <b>ADD A GARMENT</b> button if you wish to add or remove items (WH1060P, WH9060P, WH8060P2, WH8060F, WH8560P2, WH8560F, WH8560P3, WH8060P3 and WH7560P models).</p> <hr/> <p>If the drum is still moving, wait for it to stop before attempting to open the door.</p>
Door is open	<i>door OPEn</i>	<p>Close the door fully and press ►  .</p> <hr/> <p>Try opening and closing the door again.</p> <hr/> <p>Reposition the load, make sure the load is correctly in the drum and that protruding items are not stopping the door from closing.</p>

## FAULT CODES

---

When a continuous series of beeps is sounded, all the lights turn off on the control panel and a number appears on the display, a fault has occurred. The washer will automatically enter this mode if a fault occurs. The fault code will be displayed as *E r r* followed by a number on the digital display. To stop the sound, press any button and perform the following steps:

- ① Turn your washer off at the power point.
- ② Wait one minute and turn it back on.
- ③ Check your washer is correctly levelled.
- ④ Remove your wash load.
- ⑤ Perform a **RINSE** cycle.
- ⑥ If the fault re-occurs repeat steps ① and ②.
- ⑦ If the washer will still not work you will be required to call a Fisher & Paykel Authorised Repairer to arrange service, refer to the 'Customer care' section. Record the fault code number displayed and the serial number of your washer (located above the drum opening when the door is open) before calling. The fault code will indicate to the repairer what the problem could potentially be.

If a fault code is being displayed, you can still turn your washer off by pressing ①.

## TROUBLESHOOTING

The following is a list of problems you may encounter when using this appliance and some suggestions that may help to correct the problem. If you still have problems, contact your Fisher & Paykel trained and supported service technician.

PROBLEM	POSSIBLE CAUSES	WHAT TO DO
<b>Washer not turning on</b>	Power not switched on at the wall.	Switch the power on at the wall. Press <b>ⓘ</b> .
	Household power supply not working.	Try plugging in another electrical appliance.
	Keylock may be activated.	Press and hold the <b>🔒</b> button for three seconds.
<b>Pressing ►   does not start the fill</b>	Washer door not closed properly.	Open and reclose door.
	The washer has detected a fault.	Check if a code is being displayed on the control panel, refer to 'Fault codes'.
	Hot and cold taps not turned on.	Check that both hot and cold taps are turned on (if using cold inlet only ensure inlet valve cap is installed on the hot valve on the washer).
	Hot and cold taps not connected to the corresponding valve on the washer.	Check the cold tap is connected to the cold valve on the washer and the hot tap is connected to the hot valve.
	Blocked hose filters.	Check the tap end of the inlet hose(s) for blockages.
	Inlet hose leaking, twisted or damaged.	Check the inlet hose(s) for leaks or damage. Check that the inlet hose(s) are not twisted.
	Faulty water supply.	Check taps that aren't connected to the washer are working.
	Delay start maybe set.	Refer to ' <b>DELAY START</b> '.
<b>Washer stops working mid cycle</b>	The washer has detected a fault.	Refer to 'User warnings' or 'Fault codes'.
	Power or water failure.	Check the power and/or water is working correctly.
	Washer has been paused.	Press the <b>►  </b> button to continue.
	Oversudsing.	Washer is waiting for suds to dissolve before continuing the cycle.
<b>Washer drains while filling</b>	Drain hose too low.	Ensure the height of the drain hose is at least 600mm from the floor level, 'Draining'.
	Drain hose sitting in water.	Clear the drain.

## TROUBLESHOOTING

<b>PROBLEM</b>	<b>POSSIBLE CAUSES</b>	<b>WHAT TO DO</b>
<b>Washer is not draining</b>	Drain hose blocked.	Clear the drain hose.
	Pump filter blocked.	Clear the pump filter, refer to 'Cleaning the pump filter'.
	Drain hose guide higher than 1200mm above floor level.	Lower the level of the drain hose guide. Refer to 'Draining'.
<b>Filling continuously</b>	Drain hose not connected to standpipe, tub or spigot.	Connect drain hose correctly. Refer to 'Draining'.
	Washer is siphoning.	Ensure standpipe or tub is at least 600mm from the floor level.
<b>Poor rinsing</b>	Incorrect detergent used.	Use low sudsing, front loader detergent only.
	Too much detergent used.	Ensure the correct dose of detergent is used for the load size and soil level. Refer to 'Where to put the detergent'.
<b>Not spinning properly</b>	Load has gone out of balance.	Open the door and redistribute the load. Restart the washer.
	Suds build up.	Check the amount of detergent used, reduce if necessary.
<b>Too many soap suds</b>	Incorrect type of detergent used.	Use low sudsing, front loader detergent only. Refer to 'Where to put the detergent'.
	Too much detergent used.	Ensure the correct dose of detergent is used for the load size and soil level. Refer to 'Where to put the detergent'.
	Inlet water pressure/flow rate too low.	Ensure correct inlet water pressure and flow rate as per installation instructions.
<b>Small puddle of water from under the washer</b>	Inlet hose(s) or drain hose leaking.	Check inlet hose(s) and the drain hose are correctly attached and not damaged.
	Lots of suds.	Suds may have leaked and then dissolved.
	Dispenser compartments blocked.	Refer to 'Cleaning the detergent dispenser drawer'.
	Dispenser drawer not fully closed.	Close dispenser drawer fully and ensure it remains closed during the cycle.
	Damage to door seal.	Check seal inside door for damage. If it sustains any damage it will need to be replaced.

## TROUBLESHOOTING

PROBLEM	POSSIBLE CAUSES	WHAT TO DO
<b>Cycle time longer than usual / inaccurate adjustment of time remaining during cycle</b>	Cycle time is approximate.	Cycle time is influenced by a number of factors. Refer to 'Wash cycles'.
	Low water pressure or flow rate.	Ensure that inlet hose filters are not blocked.
	Out of balance or oversudsing.	Recovery from out of balance or oversudsing will extend cycle time. Refer to 'Caring for your washer'.
	Washing a large load.	Be aware that it will take longer for the machine to fill.
	Selecting various options.	Be aware that some options will extend cycle time.
<b>Detergent or fabric softener remaining in dispenser at the end of the cycle</b>	Dispenser drawer not properly closed or was opened part way through the cycle.	Ensure the dispenser drawer is fully closed at the start of the cycle and remains closed throughout the cycle.
	Dirty or blocked dispenser.	Clean the dispenser drawer. Refer to 'Cleaning the detergent dispenser drawer'.
	Liquid sitting at the 'Max' level at the end of the cycle indicates a blockage.	Clean the fabric softener dispenser compartment. Refer to 'Cleaning the detergent dispenser drawer'.
	Dispenser over loaded with detergent.	Clean out remaining detergent. Refer to 'Detergent and softener'.
	Composition of the powder detergent makes it difficult to dispense.	Dissolve detergent with water to aid with dispensing.
<b>Washing very wet at the end of the cycle</b>	Cycle selected not appropriate.	Particularly short or delicate cycles have shorter spins which can result in wetter washing at the end of the cycle.
	Incorrect spin speed for load selected.	Select a faster spin speed.
	An out of balance load has occurred.	The washer compensates for the out of balance by using a lower spin speed, to reduce noise and potential damage to the product.

## TROUBLESHOOTING

PROBLEM	POSSIBLE CAUSES	WHAT TO DO
Vibrating	Transit bolts left in place.	Ensure transit bolts are removed prior to use of the washer. Refer to 'Removing the transit bolts'.
	Washer may not be level.	Ensure washer is installed on an appropriate surface and levelled correctly. Refer to 'Levelling the washer'.
	Load is out of balance.	Wash an average sized load rather than a smaller load or a single item. Washing one item at a time is not recommended as it is difficult for the washer to balance a single item during spin.
Creasing	Washer overloaded.	Do not overload the washer.
	Incorrect cycle for load type.	Use the <b>EASY IRON</b> , <b>DELICATE</b> or <b>STEAM REFRESH</b> cycle for creasable items.
	Spin speed too fast.	Select a slower spin speed.
	Wet clothes left in washer or laundry basket.	Laundry left sitting wet is more likely to crease. If not removing clothes from washer immediately at end of cycle, select the <b>WRINKLE FREE</b> option. Do not leave wet washing sitting in a washing basket.
	Wash temperature too hot for load type.	Select a lower wash temperature. Check items care label for correct care. Check the hot and cold taps are connected to the correct valves. Refer to 'Water supply'.
	Items not sorted correctly.	Sort load so that items of similar weight are washed together.



## TROUBLESHOOTING

PROBLEM	POSSIBLE CAUSES	WHAT TO DO
Poor soil removal	Incorrect wash cycle selected.	Select a wash cycle that is appropriate for the amount of dirt. Refer to 'Wash cycles'.
	Insufficient detergent.	Ensure the correct dose of detergent is used for the load size and soil level. Refer to 'Detergent and softener'.
	Washer overloaded.	Ensure the washer is not overloaded in terms of its capacity or the cycle selected. Refer to 'Loading'.
	Items require a longer wash time.	Select a higher <b>SOIL LEVEL</b> or <b>WASH +</b> option if available.
	Load was particularly dirty.	Select <b>PRE WASH</b> for particularly dirty loads. Refer to 'Wash cycle options'.
	Items not sorted correctly.	Wash heavily and lightly soiled garments separately.
	Washer dirty from previous wash.	After washing particularly dirty clothing, we recommend putting the washer through a <b>RINSE</b> cycle once the load has been removed. This washes away any remnants of dirt that could affect future wash performance.
	Incorrect wash temperature selected in relation to the type of soil.	Select a wash temperature suitable for the type of soil, eg warm for greasy soils, cold for muddy soils. Increasing the wash temperature generally improves soil removal and overall wash performance.  Ensure garments can be washed at the increased temperature.
Dye transfer	Coloured items not washed separately from white/light coloured items.	Remember to separate whites and colours.
	New or non-colourfast items not washed separately.	Wash non-colourfast items separately and select <b>COLD</b> wash temperature.
	Wet items have been left sitting for too long.	Remove items from washer as soon as the cycle is finished, or if items are not to be removed from the washer immediately select <b>WRINKLE FREE</b> .
	Wash temperature.	Consider the wash temperature you select for your coloured items. Lower the temperature if you are concerned.

## TROUBLESHOOTING

PROBLEM	POSSIBLE CAUSES	WHAT TO DO
<b>Black or grey marks on clothes</b>	Correct amount of detergent.	Ensure the correct dose of detergent is used for the load size and soil level. Refer to 'Detergent and softener'.
	Washer needs to be cleaned.	Empty the machine and complete a <b>DRUM CLEAN</b> cycle. Refer to 'Cleaning the drum and the door'.
<b>Tangling</b>	Items not sorted correctly.	Separate larger items from smaller items.
	Washer loaded incorrectly.	Load items loosely and individually into the washer (ie not folded).
	Incorrect cycle for load type selected.	Use the <b>EASY IRON</b> or <b>STEAM REFRESH</b> cycle for items that crease easily
	Overloaded in terms of its capacity or the cycle selected.	Refer to 'Wash cycles' for recommended maximum load size.
	Delicate items.	Wash pantyhose, bras and any other delicate items prone to tangling in a mesh laundry bag.
<b>Washer Smells</b>	Not using enough detergent for the soil level in your loads.	Run a <b>DRUM CLEAN</b> cycle.
		Buy a better quality detergent or use a higher dose.
		Different detergents have different cleaning chemicals, consider alternating detergents to help remove odour.
<b>Wet patches on clothes/items</b>	Clothes are slightly damp from the steam.	It is normal for items to be damp after using the <b>STEAM REFRESH</b> , this helps remove the wrinkles. Remove the item from the washer immediately at the end of the cycle and hang up to dry.

Contact a Fisher & Paykel trained and supported service technician if a problem persists.

## MANUFACTURER'S WARRANTY

---

For New Zealand and Australia only. You automatically receive a two-year Manufacturer's Warranty with the purchase of this clothes washer covering parts and labour for servicing within the country of purchase.

### **Fisher & Paykel undertakes to:**

Repair or, at its option, replace without cost to the owner either for material or labour any part of the product, the serial number of which appears on the product, which is found to be defective within two years of the date of purchase.

You also receive an additional eight-year parts only Manufacturer's Warranty on your Direct Drive motor. This additional eight-year Manufacturer's Warranty commences on the day following the expiry of the two-year Manufacturer's Warranty and excludes the motor controller and labour. Fisher & Paykel will repair (as to parts) or, at its option, replace any Direct Drive motor (but not the motor controller) which is found to be defective within this additional Manufacturer's Warranty period. You will be responsible for any labour costs.

Note: These Manufacturer's Warranties are an extra benefit and do not affect your legal rights.

### **These Manufacturer's Warranties DO NOT cover**

- Ⓐ Service calls which are not related to any defect in the product. The cost of a service call will be charged if the problem is not found to be a product fault. For example:
  - ① Correcting the installation, eg removal of bottom packer and transit bolts (front loading washers), levelling the washer, adjustment of the drain to correct siphoning, noises, crossed, kinked or leaking inlet hose connections, turning on water, noises caused by the waterhammer or power supplies.
  - ② Providing instruction on use of the product or changing the set-up of the product, eg instruction on correct use of detergents and fabric softeners.
  - ③ Replacing fuses in, or correcting house wiring or correcting house plumbing, eg unblocking drains.
  - ④ Correcting fault(s) caused by the user.
  - ⑤ Noise or vibration that is considered normal, eg spin sounds, user warning beeps.
  - ⑥ Correcting damage caused by pests, eg rats, cockroaches, etc.
  - ⑦ Water on the floor due to incorrect loading or excessive suds.
  - ⑧ Blocked pumps, removal of foreign objects/substances from the washer, including the pump and inlet hose filters, eg bra wires, bread tags, nails, grit, scrud, etc.
  - ⑨ Correcting corrosion or discolouration due to chemical attack.
- Ⓑ Defects caused by factors other than:
  - ① Normal domestic use; or
  - ② Use in accordance with the product's User guide.
- Ⓒ Defects to the product caused by accident, neglect, misuse or 'act of God'.
- Ⓓ The cost of repairs carried out other than by a Fisher & Paykel trained and supported service technician or the cost of correcting such repairs.
- Ⓔ Normal recommended maintenance as set out in the product's User guide.
- Ⓕ Repairs when the appliance has been dismantled, repaired or serviced by other than a Fisher & Paykel trained and supported service technician or the selling dealer.
- Ⓖ Pick-up and delivery.
- Ⓖ Transportation or travelling costs involved in the repair when the product is installed outside the Fisher & Paykel trained and supported service technician's normal service area.

## MANUFACTURER'S WARRANTY

---

Nothing in this Manufacturer's Warranty is intended to, nor limits, any rights you may have under law to recover the costs of inspecting or returning the goods to us.

This product has been designed for use in a normal domestic (residential) environment. This product is not designed for any commercial use (whatsoever). Any commercial use by a customer will affect this product's Manufacturer's Warranty.

Service under these Manufacturer's Warranties must be provided by a Fisher & Paykel trained and supported service technician. Such service shall be provided during normal business hours. This Manufacturer's Warranty certificate should be shown when making any claim.

### **For Australian customers**

This Manufacturer's Warranty is an extra benefit and does not affect your legal rights. Our goods come with guarantees that cannot be excluded under the Australian Consumer Law. You are entitled to a replacement or refund for a major failure and compensation for any other reasonably foreseeable loss or damage. You are also entitled to have the goods repaired or replaced if the goods fail to be of acceptable quality and the failure does not amount to a major failure.

**Keep this user guide in a safe place.**

## CUSTOMER CARE

---

### **Before you call for service or assistance:**

Check our website, [fisherpaykel.com](http://fisherpaykel.com), for 'Product Help' to see the latest updates, hints and tips, and information about your product.

We recommend that you also refer to your user guide to ensure:

- ① Your product is correctly installed.
- ② You are familiar with its normal operation.
- ③ You have read the 'Before you call for service', 'Fault codes' and 'Troubleshooting' at the back of the book.

If after checking these points you still need assistance or parts, you can go online to our website and book a service with your nearest Fisher & Paykel trained and supported service technician. Our Customer Care team is also available to offer you assistance.

### **In New Zealand if you need service or assistance:**

Go online to our website and book a service or call the Fisher & Paykel Customer Care Centre and talk to one of our Customer Care Consultants.

**Toll Free:** 0800 FP CARE or 0800 372 273

**Email:** [customer.care@fisherpaykel.com](mailto:customer.care@fisherpaykel.com)

**Website:** [fisherpaykel.com](http://fisherpaykel.com)

**Postal address:** Fisher & Paykel Appliances Ltd, PO Box 58550, Botany, Auckland 2163

Fisher & Paykel has a network of Fisher & Paykel trained and supported service technicians who can carry out any service necessary on your appliance. Visit our website and book a service with a Fisher & Paykel trained and supported service technician in your area.

### **In Australia if you need service or assistance:**

Go online to our website and book a service or call the Fisher & Paykel Customer Care Centre and talk to one of our Customer Care Consultants.

**Toll Free:** 1300 650 590

**Email:** [customer.care@fisherpaykel.com](mailto:customer.care@fisherpaykel.com)

**Website:** [fisherpaykel.com](http://fisherpaykel.com)

**Postal address:** Fisher & Paykel Appliances Australia Pty Ltd, PO Box 798, Cleveland QLD 4163

Fisher & Paykel has a network of Fisher & Paykel trained and supported service technicians who can carry out any service necessary on your appliance.

Visit our website and book a service with a Fisher & Paykel trained and supported service technician in your area.

**If you call, write to or contact us via our website, please provide your name and address, model number, serial number, date of purchase and a complete description of the problem. This information is needed in order to better respond to your request for assistance.**

**Product details can be found on the rear of the washing machine, and/or above the drum opening (when the door is open).**

## CUSTOMER CARE

---

### Registration

Register your product with us so we can provide you with the best service possible.  
To register your product visit our website: [fisherpaykel.com](http://fisherpaykel.com)

Complete and keep for safe reference:

Model	_____
Serial No.	_____
Purchase Date	_____
Purchaser	_____
Dealer	_____
Suburb	_____
Town	_____
Country	_____



**FISHERPAYKEL.COM**

© Fisher & Paykel Appliances 2020. All rights reserved.

The models shown in this guide may not be available in all markets  
and are subject to change at any time.

The product specifications in this guide apply to the specific products and  
models described at the date of issue. Under our policy of continuous product  
improvement, these specifications may change at any time.

For current details about model and specification availability in your country,  
please go to our website or contact your local Fisher & Paykel dealer.

**430218B 11.20**