

Operating and installation instructions Induction cooktops



To prevent the risk of accidents or damage to the appliance, it is **essential** to read these instructions before it is installed and used for the first time.

Contents

Warning and Safety instructions	4
Caring for the environment	15
Overview	16
Cooktop	16
KM 7200 FR	16
KM 7201 FR	17
KM 7210 FR	18
KM 7262 FR	19
Controls and display	20
Cooking zone data	22
Before using for the first time	24
Cleaning the cooktop for the first time	24
Switching on the cooktop for the first time	24
Induction	25
How it works	25
Cookware	25
Noises	27
Tips on saving energy	28
Power level range	29
Operation	30
Operating principles	30
Switching on the cooktop	31
Setting the power level	31
Changing the power level	31
Switching off a cooking zone/the cooktop	31
Residual heat indicator	32
Setting the power level - extended setting range	32
Auto heat-up	33
Booster	34
Keeping warm	35
Timer	36
Minute minder duration	36
Switching off a cooking zone automatically	37
Using both timer functions at the same time	38
Additional functions	39
Stop & Go	39

Contents

Recall.....	39
Demonstration mode.....	40
Displaying cooktop data	40
Safety features	41
System lock / Safety lock.....	41
Safety switch-off	43
Overheating protection.....	44
Programming	45
Cleaning and care	48
Problem solving guide	50
Optional accessories	53
Service	54
Contact in case of fault	54
Data plate	54
Warranty	54
Installation	55
Safety instructions for installation	55
Safety distances.....	56
Installation notes	58
Installation dimensions.....	59
KM 7200 FR	59
KM 7201 FR	60
KM 7210 FR	61
KM 7262 FR	62
Installation	63
Electrical connection	64

Warning and Safety instructions

This cooktop complies with all relevant local and national safety requirements. However, inappropriate use can lead to personal injury and damage to property.

Read the operating and installation instructions carefully before using the cooktop. They contain important information on safety, installation, use and maintenance of the appliance. This prevents both personal injury and damage to the cooktop.

In accordance with standard IEC 60335-1, Miele expressly and strongly advises that you read and follow the instructions in “Installation”, as well as in the “Warning and Safety instructions”.

Miele cannot be held liable for injury or damage caused by non-compliance with these instructions.

Keep these instructions in a safe place and pass them on to any future owner.

Correct application

- ▶ This cooktop is designed for domestic use and for use in similar environments by guests in hotel or motel rooms, bed & breakfasts and other typical living quarters. This does not include common/shared facilities or commercial facilities within hotels, motels or bed & breakfasts.
- ▶ This cooktop is not suitable for outdoor use.
- ▶ It is intended only to cook food and keep it warm. Any other use is not supported by Miele and could be dangerous.
- ▶ This cooktop is not intended for use by people (including children) with reduced physical, sensory or mental capabilities or lack of experience and knowledge, unless they have been given supervision and instruction concerning its use by a person responsible for their safety. They may only use the cooktop unsupervised if they have been shown how to use it in a safe way. They must be able to recognise and understand the potential dangers of improper use.

Warning and Safety instructions

Safety with children

- ▶ Young children must not be allowed to use this appliance.
- ▶ Older children may only use the appliance if its operation has been clearly explained to them and they are able to use it safely. They must be aware of the potential dangers caused by incorrect operation.
- ▶ Cleaning may only be carried out by older children under the supervision of an adult.
- ▶ Please supervise children in the vicinity of the cooktop and do not let them play with it.
- ▶ The cooktop gets hot when in use and remains hot for a while after being switched off. Keep children well away from the cooktop until it has cooled down and there is no danger of burning.
- ▶ Danger of burning! Do not store anything which might arouse a child's interest in storage areas above or behind the cooktop. Otherwise children could be tempted to climb onto the cooktop with the risk of burning themselves.
- ▶ Danger of burning and scalding! Turn the handles of pots and pans on the cooktop to the side or the rear so that children cannot pull them down and burn themselves.
- ▶ Danger of suffocation! Whilst playing, children may become entangled in packaging material (such as plastic wrapping) or pull it over their head with the risk of suffocation. Keep packaging material away from children.
- ▶ Activate the system lock to ensure that children cannot switch on the cooktop inadvertently. Use the safety lock when the cooktop is in use to prevent children from altering the settings selected.

Technical safety

- ▶ Unauthorised installation, maintenance and repairs (including removal of any cover) can cause considerable danger for the user. Installation, maintenance and repairs must only be carried out by a Miele authorised technician.
- ▶ Damage to the cooktop can compromise your safety. Check the appliance for visible signs of damage. Do not use the cooktop if it is damaged.
- ▶ Reliable and safe operation of this cooktop can only be assured if it has been connected to the mains electricity supply.
- ▶ The cooktop must not be connected to the inverter of an autonomous power supply, e.g. **a solar power system**. When the cooktop is switched on, power surges could result in a safety switch-off. This may damage the electronic unit.
- ▶ The electrical safety of this appliance can only be guaranteed when continuity is complete between it and an effective earthing system which complies with local and national safety regulations. It is most important that this basic safety requirement is present and tested regularly and, where there is any doubt, the household wiring system should be inspected by a qualified electrician.
- ▶ Before connecting the appliance to the mains electricity supply, ensure that the connection data on the data plate (voltage and frequency) matches the mains electricity supply. This data must correspond in order to avoid the risk of damage to the appliance.
- ▶ Do not connect the cooktop to the mains electricity supply by a multi-socket adapter or extension lead. These are a fire hazard and do not guarantee the required safety of the appliance.
- ▶ For safety reasons, this cooktop may only be used after it has been built in.
- ▶ This appliance must not be installed and operated in mobile installations (e.g. on a ship).

Warning and Safety instructions

▶ Never open the casing of the cooktop.

Touching or tampering with electrical connections or components and mechanical parts is highly dangerous to the user and can cause operational faults.

▶ The manufacturer's warranty will be invalidated if the appliance is not repaired by a Miele authorised service technician.

▶ Faulty components must only be replaced by genuine Miele spare parts. The manufacturer can only guarantee the safety of the appliance when Miele replacement parts are used.

▶ The cooktop is not intended for use with an external timer switch or a remote control system.

▶ The cooktop must be connected to the electricity supply by a qualified electrician (see “Installation – Electrical connection”).

▶ If the mains connection cable is damaged, it must be replaced with a special mains connection cable, available from Miele, by a Miele authorised service technician or suitably qualified and competent electrician in order to avoid a hazard (see “Installation - Electrical connection”).

▶ During installation, maintenance and repair work, the appliance must be disconnected from the mains electricity supply. It is only completely isolated from the electricity supply when:

- the mains circuit breaker is switched off, or
- it is switched off at the wall socket and the plug is withdrawn from the socket. Do not pull the mains connection cable but the mains plug to disconnect your appliance from the mains electricity supply.

▶ Danger of electric shock! If the ceramic surface is faulty, cracked, chipped or damaged in any way, do not use the cooktop and switch it off immediately. Disconnect the cooktop from the electricity supply. Contact Miele.

Warning and Safety instructions

- ▶ If the cooktop is installed behind a furniture door, do not close the door while the cooktop is in operation. Heat and moisture can build up behind the closed door. This can result in damage to the cooktop, the housing unit and the floor. Do not close the door until the appliance has cooled down and the residual heat indicators have gone out.
- ▶ In areas which may be subject to infestation by cockroaches or other vermin, pay particular attention to keeping the appliance and its surroundings clean at all times. Any damage caused by cockroaches or other vermin will not be covered by the warranty.
- ▶ DO NOT MODIFY THIS APPLIANCE.

Warning and Safety instructions

Correct use

- ▶ The cooktop gets hot when in use and remains hot for a while after being switched off. There is a danger of burning until the residual heat indicators go out.
- ▶ Oil and fat can overheat and catch fire. Do not leave the cooktop unattended when cooking with oil and fat. If it does ignite, do not attempt to put the flames out with water. Switch off the cooktop and use a suitable fire blanket, saucepan lid, damp towel or similar to smother the flames.
- ▶ The cooking process has to be supervised. A short term cooking process has to be supervised continuously.
- ▶ Flames could set the grease filters of a rangehood on fire. Do not flambé under a rangehood.
- ▶ Spray canisters, aerosols and other inflammable substances can ignite when heated. Therefore do not store such items or substances in a drawer under the cooktop. Cutlery inserts must be heatresistant.
- ▶ Do not heat an empty pan.
- ▶ Do not heat up food in closed containers e.g. tins or sealed jars on the cooktop, as pressure can build up in the containers, causing them to explode.
- ▶ Do not cover the cooktop, e.g. with a cooktop cover, a cloth or protective foil. The material could catch fire, shatter or melt if the cooktop is switched on by mistake or if residual heat is still present.
- ▶ When the appliance is switched on either deliberately or by mistake, or when there is residual heat present, there is the risk of any metal items left on the cooktop heating up, with the danger of burning. Depending on the material, other items left on the cooktop could also melt or catch fire. Damp pan lids might adhere to the ceramic surface and be difficult to dislodge. Do not use the appliance as a resting place. Switch the cooking zones off after use and do not rely on the pan detector.

Warning and Safety instructions

- ▶ You could burn yourself on the hot cooktop. Protect your hands with heat-resistant pot holders or oven gloves when handling hot pots and pans. Do not let them get wet or damp, as this causes heat to transfer through the material more quickly with the risk of scalding or burning yourself.
- ▶ When using an electrical appliance, e.g. a hand-held food mixer, near the cooktop, ensure that the cable of the electrical appliance cannot come into contact with the hot cooktop. The insulation on the cable could become damaged.
- ▶ Grains of salt, sugar and sand (e.g. from cleaning vegetables) can cause scratches if they get under pan bases. Make sure that the ceramic surface is clean before placing pans on it.
- ▶ Even a light object can cause damage in certain circumstances. Do not drop anything on the ceramic surface.
- ▶ Placing hot pans on the sensors and indicators could damage the electronics underneath. Do not place hot pans on the sensors or indicators.
- ▶ Do not allow solid or liquid sugar, or pieces of plastic or aluminium foil to get onto the cooktop when it is hot, as they can damage the ceramic surface when it cools down. If this should occur, switch off the appliance and scrape off all the sugar, plastic or aluminium residues whilst still hot, using a shielded scraper blade suitable for use on glass. Wear oven gloves when doing this. Allow the ceramic surface to cool down and then clean it with a suitable ceramic cooktop cleaning agent.
- ▶ Pans which boil dry can cause damage to the ceramic glass. Do not leave the cooktop unattended whilst it is being used.
- ▶ Only use pots and pans with smooth bases. Rough bases will scratch the ceramic glass.
- ▶ Lift pans into position on the cooktop. Sliding them into place can cause scuffs and scratches.

Warning and Safety instructions

- ▶ Because induction heating works extremely quickly, the base of the pan could heat up to the temperature at which oil or fat self-ignites within a very short time. Do not leave the cooktop unattended whilst it is being used.
- ▶ Heat oil or fat for a maximum of one minute. Never use the Booster function to heat oil or fat.
- ▶ For people fitted with a heart pacemaker: please note that the area immediately surrounding the cooktop is electromagnetically charged when it is switched on. It is very unlikely to affect a pacemaker. However, if in any doubt, consult the manufacturer of the pacemaker or your doctor.
- ▶ To prevent damage to items which are susceptible to electromagnetic fields, e.g. credit cards, digital storage devices, pocket calculators, etc., do not leave them in the immediate vicinity of the cooktop.
- ▶ Metal utensils stored in a drawer under the cooktop can become hot if the appliance is used intensively for a long time. Do not store any metal items or utensils in a drawer under the cooktop.
- ▶ The cooktop is fitted with a cooling fan. If a drawer is fitted directly underneath the cooktop, ensure that there is sufficient space between the drawer and its contents and the underside of the cooktop in order to ensure sufficient ventilation for the cooktop.
- ▶ The cooktop is fitted with a cooling fan. If a drawer is fitted directly underneath the cooktop, ensure that there is sufficient space between the drawer and its contents and the underside of the cooktop in order to ensure sufficient ventilation of the cooktop. Do not store pointed or small items or paper in the drawer. They could get in through the ventilation slots or be sucked into the casing by the fan and damage the fan or impair cooling.
- ▶ Never use two pans on a cooking zone or extended zone at the same time.

Warning and Safety instructions

- ▶ If the cookware only partially covers a cooking zone or extended zone, the handle could become very hot.
Always place cookware in the middle of a cooking zone or extended zone!

Warning and Safety instructions

Cleaning and care

- ▶ Do not use a steam cleaning appliance to clean this appliance. The steam could reach the electrical components and cause a short circuit.
- ▶ If the cooktop is built in over a pyrolytic oven, the cooktop should not be used whilst the pyrolytic process is being carried out, as this could trigger the overheating protection mechanism on the cooktop (see “Safety features - Overheating protection”).

Disposal of the packing material

The transport and protective packaging has been selected from materials which are environmentally friendly for disposal, and can normally be recycled.

Recycling the packaging reduces the use of raw materials in the manufacturing process and also reduces the amount of waste in landfill sites. Ensure that any plastic wrappings, bags etc. are disposed of safely and kept out of the reach of babies and young children. Danger of suffocation.

Disposing of your old appliance

Electrical and electronic appliances often contain valuable materials. They also contain specific materials, compounds and components, which were essential for their correct function and safety. These could be hazardous to human health and to the environment if disposed of with your domestic waste or if handled incorrectly. Please do not, therefore, dispose of your old appliance with your household waste.



Please dispose of it at your local community waste collection / recycling centre for electrical and electronic appliances. You are also responsible for deleting any personal data that may be stored on the appliance prior to disposal. Please ensure that your old appliance poses no risk to children while being stored prior to disposal.

Overview

Cooktop

KM 7200 FR

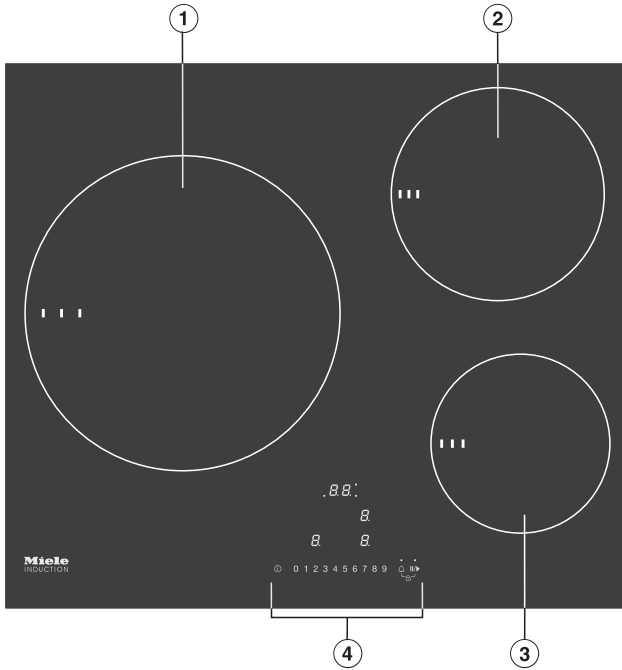

- ① Cooking zone with TwinBooster
- ② Cooking zone with TwinBooster
- ③ Cooking zone with TwinBooster
- ④ Controls and indicators

KM 7201 FR

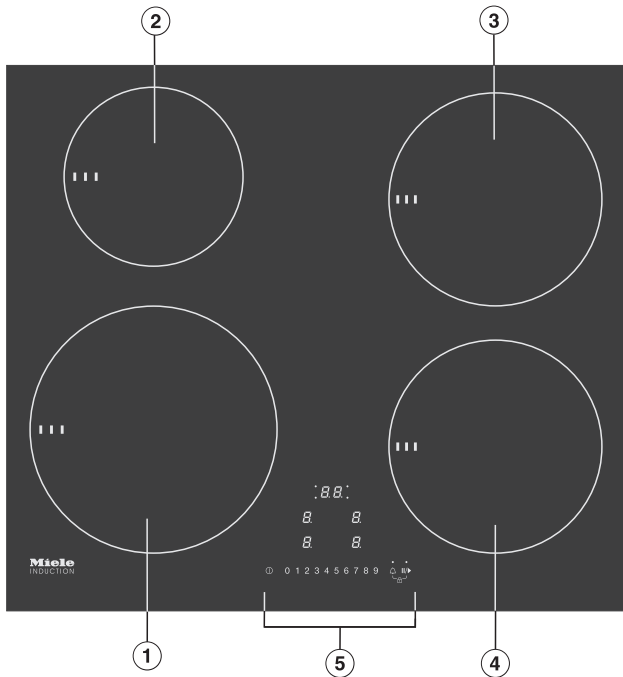

- ① Cooking zone with TwinBooster
- ② Cooking zone with TwinBooster
- ③ Cooking zone with TwinBooster
- ④ Cooking zone with TwinBooster
- ⑤ Controls and indicators

Overview

KM 7210 FR

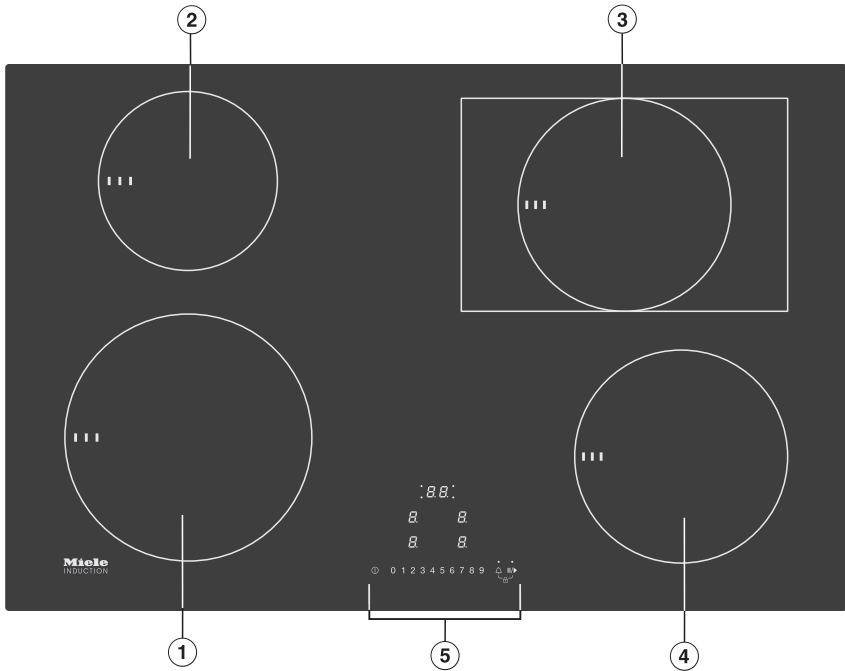

- ① Cooking zone with TwinBooster
- ② Cooking zone with TwinBooster
- ③ Extended zone with TwinBooster
- ④ Cooking zone with TwinBooster
- ⑤ Controls and indicators

KM 7262 FR

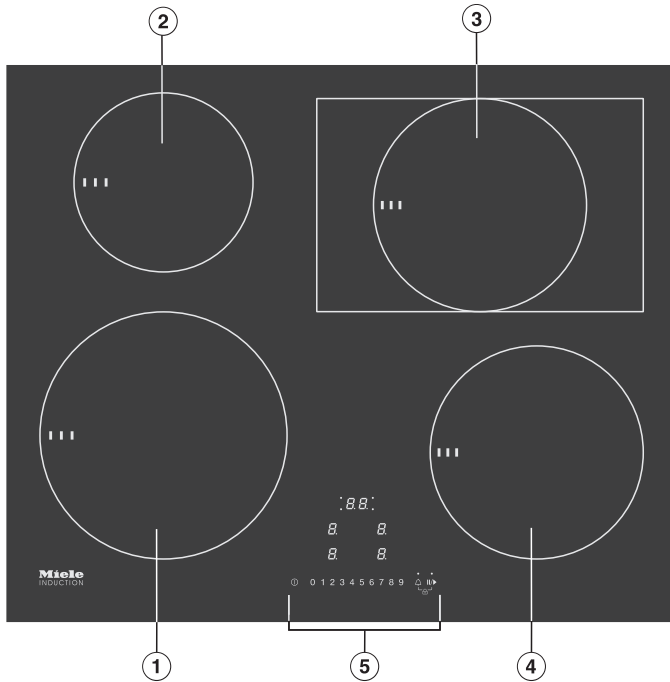

- ① Cooking zone with TwinBooster
- ② Cooking zone with TwinBooster
- ③ Extended zone with TwinBooster
- ④ Cooking zone with TwinBooster
- ⑤ Controls and indicators

Overview

Controls and display

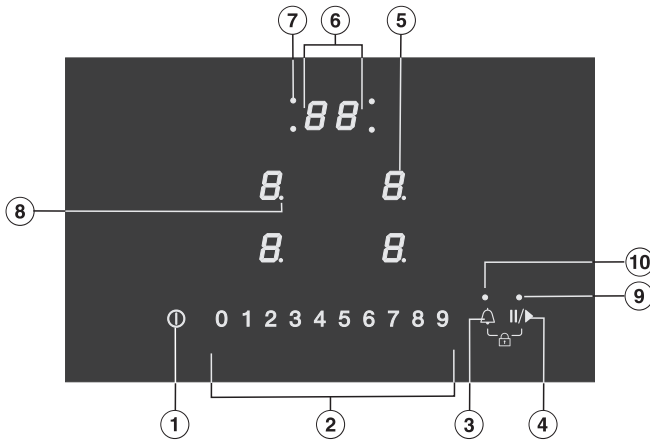

Sensor controls

- ① For switching the cooktop on/off
- ② Numerical keybank
 - For setting the power level
 - For setting the timer
- ③ Timer
 - For switching on and off
 - For switching between timer functions
 - For selecting a cooking zone (see “Timer - Switching a cooking zone off automatically”)
- ④ Stop & Go
- ⑤ Cooking zone selection and display

<i>⏻</i>	Cooking zone ready for use
<i>h</i>	Keeping warm function
<i>1 to 9</i>	Power level
<i>,</i>	TwinBooster level 1
<i>,,</i>	TwinBooster level 2
<i>⏻</i>	No pan on cooking zone or pan unsuitable (see “Induction - Cookware”)
<i>≡</i>	Residual heat
<i>R</i>	Auto heat-up

Display / Indicator lights

- ⑥ Timer display
 - 00 to 99* Duration in minutes
 - LL* System lock/Safety lock activated
 - dE* Demonstration mode activated
- ⑦ Automatic switch-off allocation of cooking zones
- ⑧ Extended power level range setting
- ⑨ Stop & Go activated
- ⑩ Timer

Overview

Cooking zone data

KM 7200 FR			
Cooking zone	Ø in cm*	Rating in watts for 230 V**	
①	14–28	Normal	2,600
		TwinBooster, level 1	3,300
		TwinBooster, level 2	5,500
②	14–19	Normal	1,850
		TwinBooster, level 1	2,500
		TwinBooster, level 2	3,000
③	10–16	Normal	1,400
		TwinBooster, level 1	1,700
		TwinBooster, level 2	2,200
		Total	7,300

* Pans with any base diameter within the given range may be used.

** The wattage quoted may vary depending on the size and material of the cookware used.

KM 7201 FR			
Cooking zone	Ø in cm*	Rating in watts for 230 V**	
①	16–22	Normal	2,300
		TwinBooster, level 1	3,000
		TwinBooster, level 2	3,650
②	10–16	Normal	1,400
		TwinBooster, level 1	1,700
		TwinBooster, level 2	2,200
③	14–19	Normal	1,850
		TwinBooster, level 1	2,500
		TwinBooster, level 2	3,000
④	14–19	Normal	1,850
		TwinBooster, level 1	2,500
		TwinBooster, level 2	3,000
		Total	7,300

* Pans with any base diameter within the given range may be used.

** The wattage quoted may vary depending on the size and material of the cookware used.

KM 7210 FR, KM 7262 FR			
Cooking zone	Size in cm		Max. rating in watts for 230 V ³
	∅ ¹	 ²	
①	16–22	–	Normal 2,300 TwinBooster, level 1 3,000 TwinBooster, level 2 3,650
②	10–16	–	Normal 1,400 TwinBooster, level 1 1,700 TwinBooster, level 2 2,200
③	14–19	–	Normal 1,850 TwinBooster, level 1 2,500 TwinBooster, level 2 3,000
	–	19X29	Normal 2,100 TwinBooster, level 1 3,000 TwinBooster, level 2 3,650
④	14–19	–	Normal 1,850 TwinBooster, level 1 2,500 TwinBooster, level 2 3,000
			Total 7,300

¹ Pans with a base diameter within the given range may be used.

² The given range corresponds to the maximum base surface of the pans that may be used.

³ The power level given may vary depending on the size and material of the pans used.

Before using for the first time

- Please stick the extra data plate for the appliance supplied with this documentation in the space provided in the “Service” section of this booklet. Alternatively, the additional label can be stuck near the appliance if the appliance markings are not visible after installation.
- Remove any protective wrapping and stickers (except the data plate).

Cleaning the cooktop for the first time

- Before using for the first time, clean the cooktop with a damp cloth only and then wipe dry.

Switching on the cooktop for the first time

The metal components have a protective coating which may give off a slight smell when heated up for the first time. The induction coils may also give off a slight smell for the first few hours of operation. This smell will be less noticeable with each subsequent use before dissipating completely.

The smell and any vapours given off do not indicate a faulty connection or appliance and they are not hazardous to health.

Please note that the heating up time on induction cooktops is significantly shorter than on conventional cooktops.

How it works

An induction coil is located under each cooking zone. The coil creates a magnetic field that reacts directly with the base of the pan and heats it up. The cooking zone itself is heated up indirectly by the heat given off by the pan.

An induction cooking zone only works when a pan with a magnetic base is placed on it (see “Induction - Cookware”). Induction automatically recognises the size of the pan.



Risk of burning due to hot items!

When the cooktop is switched on, either deliberately or by mistake, or when there is residual heat present, there is a risk of metal items placed on the cooktop heating up.

Do not use the cooktop as a resting place for anything else.

After use, switch the cooktop off with the  sensor control.

Cookware

Suitable pans

- stainless steel pans with a base that can be magnetised
- enamelled steel pans
- cast iron pans

Please be aware that the properties of the pan base can affect the evenness with which the food heats up (e.g. when making pancakes). The base of the pan must be able to distribute the heat evenly. A sandwich base made of stainless steel is particularly suitable.

Unsuitable pans

- stainless steel pans with a base which cannot be magnetised
- aluminium or copper pans
- glass, ceramic or earthenware pots and pans

Testing cookware

To test whether a pot or pan is suitable for use on an induction cooktop, hold a magnet to the base of the pan in several different places. If the magnet sticks, the pan is generally suitable.

Induction

No pan/unsuitable pan display

The \mathcal{U} symbol flashes alternately with the power level selected in one of the cooking zone displays

- if the cooking zone has been switched on without a pan in place, or if the pan is unsuitable (non-magnetic base).
- if the diameter of the base of the pan is too small.
- if the pan is taken off the cooking zone while it is switched on.

If a suitable pan is placed on the cooking zone within 3 minutes, \mathcal{U} will go out and you can continue as normal.

If no pan or an unsuitable pan is placed on the cooking zone, the cooking zone will switch off automatically after 3 minutes.

Useful tips

- To make optimum use of the cooking zones, choose pans with a suitable base diameter (see “Overview - Cooking zone data”). If the pan is too small it will not be recognised.
- Use only pots and pans with smooth bases. Rough bases can scratch the ceramic glass.
- Always lift the pans to move them. This will help prevent scratching. If any scratches do appear as a result of pans being pushed around, this will not affect the function of the cooktop. These scratches are normal signs of use and are not grounds for making a complaint.
- Please note that the maximum diameter quoted by manufacturers often refers to the diameter of the top rim of the pot or pan. The diameter of the base (generally smaller) is more important.

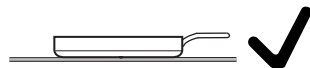

- Where possible, use pans with vertically straight sides. If a pan has angular sides, induction also acts on the sides of the pan. The sides of the pan may discolour or the coating may peel off.

Noises

When using an induction cooking zone, the following noises can occur in the pan, depending on what it is made of and how it has been constructed.

On the higher power settings, the appliance might buzz. This will decrease or cease altogether when the power setting is reduced.

If the pan base is made of layers of different materials (e.g. in a sandwiched base), it might emit a cracking sound.

Whistling might occur if linked zones (see “Operation - Booster”) are being used at the same time, and the pans also have bases made of layers of different materials.

You might hear a clicking sound from the electronic switches, especially on lower power settings.

You might hear a whirring sound when the cooling fan switches on. It switches on to protect the electronics when the cooktop is being used intensively. The fan may continue to run after the cooktop has been switched off.

Tips on saving energy

- Use a lid whenever possible to minimise heat loss.
- Select a smaller pan when cooking small quantities. A smaller pan uses less energy than a larger pan with very little in it.
- Cook with as little water as possible.
- Once food has come to the boil or the oil in the pan is hot enough for frying, reduce the heat to a lower setting.
- Use a pressure cooker to reduce cooking times.

Power level range

The cooktop is programmed with 9 power levels at the factory. If you wish to fine-tune a setting, you can extend the power level range to 17 power levels (see “Programming”).

	Power level range	
	Default setting (9 power levels)	Extended settings (17 power levels)
Melting butter Melting chocolate Dissolving gelatine	1–2	1–2.
Warming up small quantities of liquid Keeping warm food which sticks easily Cooking rice or porridge Defrosting vegetables frozen in a block	2–4	2–3.
Warming up liquid and semi-solid food Steaming fruit Simmering potatoes (pans with lids)	4–6	3.–5.
Making omelettes or lightly fried eggs Gently frying rissoles Steaming fish and vegetables Cooking dumplings and dried pulses Defrosting and warming up frozen food Thickening sauces, e.g. Hollandaise	5–7	4.–7.
Gently frying meat, fish, sausages and eggs (without overheating the fat)	6–8	6–7.
Cooking potato fritters, pancakes etc.	7–8	7–8.
Boiling large quantities of water Bringing to the boil Searing large amounts of meat	9	8.–9

These settings should only be taken as a guide. The power of the induction coils will vary depending on the size and material of the pan. For this reason, it is possible that the settings will need to be adjusted slightly to suit your pans. As you use the cooktop, you will get to know which settings suit your pans best. When using new pans that you are not familiar with, set the power level below the one specified.

Operation

Operating principles

This ceramic cooktop is equipped with electronic sensor controls which react to finger contact. For safety reasons, when switching the appliance on, the On/Off ① sensor needs to be touched for a little longer than the other sensors. Each time you touch a sensor, an acoustic signal sounds.

When the cooktop is switched off, only the printed sensor control symbols and numbers on the keybank for setting the power levels are visible. More sensor controls light up when the cooktop is switched on.

In order to set or alter a power level, the cooking zones must be “active”. To activate a cooking zone, touch the indicator of the relevant cooking zone. The relevant cooking zone indicator will begin to flash when touched. While the indicator is flashing, you can set or adjust the power level or the duration.

Exception: If only one of the cooking zones is in operation, you can alter the power level without activating the cooking zone.

⚠ Malfunction due to dirty and/or covered sensor controls.

If the sensor controls are dirty or covered this could cause them to fail to react, to activate a function inadvertently or even to switch the appliance off automatically (see “Safety features – Safety switch-off”). Placing hot pans on the sensor controls/indicators can damage the electronic unit underneath.

Keep the sensor controls and indicators clean.

Do not place anything over the sensor control or indicators.

Do not place hot pans over the sensor controls or indicators.

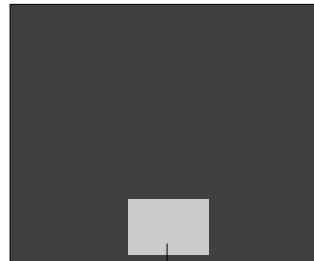

①

① Sensor controls and indicators

 Risk of fire due to overheated food.
Unattended food can overheat and ignite.
Do not leave the cooktop unattended whilst it is being used.

Please note that the heating-up time on induction cooktops is much shorter than on conventional cooktops.

Switching on the cooktop

- Touch the ① sensor.

Further sensor controls will light up.

If no further entry is made, the cooktop will switch itself off after a few seconds for safety reasons.

Setting the power level

Permanent pan recognition is activated as standard (see “Programming”). When the cooktop is switched on and you place a pan on a cooking zone, the cooking zone indicator starts to flash.

- Place a pan on the cooking zone you want to use.

The cooking zone indicator will begin to flash.

- Touch the appropriate sensor control on the numerical keybank for the power level you want.

The power level selected will flash in the display for a few seconds and then light up constantly.

Changing the power level

- Touch the relevant cooking zone indicator.

The cooking zone indicator control will begin to flash.

- Touch the appropriate sensor control on the numerical keybank for the power level you want.

Switching off a cooking zone/ the cooktop

- To switch off a cooking zone, touch the relevant cooking zone indicator.

The cooking zone indicator control will begin to flash.

- Touch the 0 sensor control on the numerical keybank.
- To switch off the cooktop and all the cooking zones, touch the ① sensor.

Operation

Residual heat indicator

If a cooking zone is still hot, the residual heat indicator will light up after it has been switched off.

The lines of the residual heat indicator go out one after another as the cooking zone cools down. The last horizontal line only goes out when the cooking zone is safe to touch.



Risk of burning on hot cooking zones!

The cooking zones will be hot after use.

Do not touch the cooking zones while the residual heat indicators are on.

Setting the power level - extended setting range

- Touch the numerical keybank between two number sensors.

The power level selected flashes in the display for a few seconds to start with and then lights up constantly. The intermediate setting will be represented by an illuminated dot next to the number.

Auto heat-up

When Auto heat-up has been activated, the highest setting automatically switches on and then switches to the continued cooking setting which you have previously selected. The heat-up time depends on which continued cooking setting has been chosen (see chart).

Activating Auto heat-up

- Briefly touch the indicator for the required cooking zone.
- Touch the sensor control for the continued cooking setting you want until a tone sounds and *H* lights up in the cooking zone display.

The *H* symbol flashes alternately with the selected power level in the cooking zone display during the heat-up time (see chart).

Changing the continued cooking setting while the cooking zone is heating up deactivates Auto heat-up.

Deactivating Auto heat-up

- Briefly touch the indicator of the required cooking zone.
- Touch the continued cooking setting you have set until *H* goes out.

Or

- Set a different power level.

Continued cooking setting*	Heat-up time [min:sec]
1	Approx. 0:15
1.	Approx. 0:15
2	Approx. 0:15
2.	Approx. 0:15
3	Approx. 0:25
3.	Approx. 0:25
4	Approx. 0:50
4.	Approx. 0:50
5	Approx. 2:00
5.	Approx. 5:50
6	Approx. 5:50
6.	Approx. 2:50
7	Approx. 2:50
7.	Approx. 2:50
8	Approx. 2:50
8.	Approx. 2:50
9	—

* The continued cooking settings with a dot after the number are only available if the power level range has been extended (see "Programming").

Operation

Booster

The cooking zones are equipped with a Booster or TwinBooster (see “Overview - Cooktop”).

When activated, the power is boosted so that large quantities can be heated up quickly, e.g. when boiling water for cooking pasta. The boost in power is active for a maximum of 15 minutes.

The Booster function can be used on a maximum of two cooking zones at the same time.

The cooking zone will automatically revert to power level 9 at the end of the Booster time.

In each case two cooking zones are linked together in order to provide sufficient power for the Booster. While the Booster is in operation some of the power is taken away from the linked cooking zone. This has one of the following effects:

- Auto heat-up is deactivated.
- The power level is reduced.
- The linked cooking zone is switched off.

Activating TwinBooster

Level 1

- Touch the sensor for the cooking zone you wish to use.
 - Touch the 9 sensor control on the numerical keybank twice.
- , appears in the cooking zone display.

Level 2

- Touch the sensor for the cooking zone you wish to use.
 - Touch the 9 sensor control on the numerical keybank three times.
- „ appears in the cooking zone display.

Deactivating TwinBooster

- Touch the sensor for the cooking zone you wish to use.
- Set a different power level.

Keeping warm

The keeping warm function is for keeping food warm that has just been cooked, i.e. food that is still hot. It is not for reheating food that has gone cold.

The maximum duration for keeping food warm is 2 hours.

- Only keep food warm in suitable cookware (pots/pans). Cover the pot/pan with a lid.
- Stir firm or viscous food (mashed potatoes, stew) occasionally.
- Nutrients are lost when food is cooked, and continue to diminish when food is kept warm. The longer food is kept warm for, the greater the loss of nutrients. Try to keep food warm for as short a time as possible.

Setting the keeping warm function

- Touch the sensor for the cooking zone you wish to use.
- Touch the numerical keybank in between sensor controls 0 and 1.
h appears in the cooking zone display.

Timer

The cooktop has to be switched on if you wish to use the timer. You can set a time up to a maximum of 99 minutes.

The timer can be used for the following 2 functions:

- For setting the minute minder
- For automatically switching a cooking zone off

Minute minder duration

Setting the minute minder

Example: You want to set a time of 15 minutes.

- Make sure the cooktop is switched on.

- Touch the \triangle sensor.

00 will flash in the timer display.

First the tens digit is set, then the units digit.

- Touch the number sensor which corresponds to the tens position (1 in this case).

The timer display then changes and 1 appears on the right.

- Touch the number sensor which corresponds to the units position (5 in this case).

The timer display will change. The 1 moves to the left and 5 appears on the right.

The minute minder will begin to count down.

Changing the time set for the minute minder

- Touch the \triangle sensor.

- Set a new minute minder time, as described above.

Cancelling the minute minder

- Touch the \triangle sensor repeatedly until 00 appears.

Switching off a cooking zone automatically

You can set a time after which the cooking zone will switch off automatically. This function can be used on all zones at the same time.

If the time programmed is longer than the maximum operational time allowed, the safety switch-off will switch off the cooking zone after the maximum permitted safety time has elapsed (see “Safety features - Safety switch-off”).

- Select a power level for the cooking zone you wish to use.
- Keep touching the  sensor until the indicator light for this cooking zone starts flashing.

If several cooking zones are on, the indicator lights flash in a clockwise direction, starting with the front left.

- Set the required time.
- If you want to set another cooking zone to switch off automatically, follow the same steps as described above.

If more than one switch-off time is programmed, the shortest time remaining will be displayed, and the corresponding indicator light will flash. The other indicator lights will light up constantly.



- If you want to show the time remaining for another zone which is counting down in the background,

touch the  sensor repeatedly until the indicator light for the zone you require flashes.

Changing the switch-off time

- Touch the  sensor repeatedly until the indicator light for the zone you require flashes.
- Set the required time.

Deleting the switch-off time



- Touch the  sensor repeatedly until the indicator light for the zone you require flashes.
- Touch  on the numerical keybank.

Timer

Using both timer functions at the same time

The minute minder and automatic switch-off functions can be used at the same time.

If you have programmed one or more switch-off times, and would like to use the minute minder as well:

- Touch the  sensor repeatedly until the indicator lights of the programmed cooking zones light up constantly and  starts flashing in the timer display.
- Set the time as described above.

If you have set the minute minder and would like to programme one or more switch-off times as well:

- Touch the  sensor repeatedly until the indicator light for the zone you require flashes.
- Set the time as described above.

Shortly after the last entry, the timer display switches to the function with the shortest remaining time.

If you want to show the times counting down in the background:

- Touch the  sensor repeatedly until
 - the indicator light for the required cooking zone flashes (automatic switch-off).
 - the timer display flashes (minute minder).

Starting with the shortest time remaining which is shown in the display, all cooking zones which are switched on and the minute minder are selected clockwise.

Stop & Go

When Stop & Go is activated, the power of all cooking zones in use is reduced to power level 1.

The power levels set for the cooking zones and the timer settings cannot be changed; the cooktop can only be switched off. The minute minder, automatic switch-off, Booster and Auto heat-up times continue to run.

When Stop & Go is deactivated, the cooking zones will operate at the power level previously selected.

If the function is not deactivated within 1 hour, the cooktop will switch off.

Activating/Deactivating

- Touch the II/▶ sensor.

Use this function when the sensors need to be cleaned quickly or there is a risk of boiling over.

Recall

If the cooktop is switched off inadvertently during operation, this function can be used to reset all settings. For this to work, the cooktop must be switched on again within 10 seconds of being switched off.

- Switch the cooktop on again.
- Immediately after switching the cooktop on, touch one of the flashing cooking zone indicators.

Additional functions

Demonstration mode

This function enables the cooktop to be demonstrated in showrooms without heating up.

Activating/Deactivating the demonstration mode

- Switch the cooktop on.
- Touch and hold the 0 and 2 sensor controls on the numerical keybank at the same time for 6 seconds.

In the timer display, *dE* flashes alternately with *Dn* (demonstration mode activated) or *DF* (demonstration mode deactivated) for a few seconds.

Displaying cooktop data

The model designation and software version can be displayed. There must not be any pots or pans on the cooktop.

Model number/Serial number

- Switch the cooktop on.
- Touch and hold the 0 and 4 sensor controls on the numerical keybank at the same time for 6 seconds.

Numbers appear in the timer display separated by a dash.

Example: *12 34* (Model number KM 1234) – *1 23 45 67 89* (Serial number)

Software version

- Switch the cooktop on.
- Touch and hold the 0 and 3 sensor controls on the numerical keybank at the same time for 6 seconds.

Numbers will flash on and off in the timer display:

Example: *12* flashing alternately with *3* = Software version 123.

System lock / Safety lock

Your cooktop is equipped with a system lock and a safety lock to prevent the cooktop and the cooking zones being switched on or any settings being altered unintentionally.

The **system lock** is activated when the cooktop is switched off. If the system lock is activated, the cooktop cannot be switched on and the timer cannot be used. A set minute minder time continues to count down. The cooktop is programmed so that the system lock must be activated manually. It can be programmed to be activated automatically 5 minutes after the cooktop has been switched off (see “Programming”).

The **safety lock** is activated while the cooktop is switched on. When the safety lock is activated, the cooktop can only be operated to a limited extent:

- The cooking zones and the cooktop can only be switched off.
- A set minute minder time can be modified.

If an unavailable sensor is touched whilst the system lock or safety lock is activated *LL* will appear in the timer display for few seconds and a tone will sound.

Activating the system lock

- Touch the ⓘ sensor for 6 seconds.

The seconds can be seen counting down in the timer display. When this time has elapsed *LL* will appear in the timer display. The system lock has been activated.



Deactivating the system lock

- Touch the ⓘ sensor for 6 seconds.

LL will appear briefly in the timer display and then the seconds will count down. The system lock is deactivated once the time has elapsed.



Safety features

Activating the safety lock

- Touch and hold the  and  sensors at the same time for 6 seconds.

The seconds can be seen counting down in the timer display. When this time has elapsed, *LL* will appear in the timer display. The safety lock is activated.

Deactivating the safety lock

- Touch and hold the  and  sensors at the same time for 6 seconds.

LL will appear briefly in the timer display and then the seconds will count down. The safety lock is deactivated once the time has elapsed.

Safety switch-off

Safety switch-off if the sensors are covered

Your cooktop will switch off automatically if one or several of the sensors remain covered for longer than 10 seconds, for example, by finger contact, food boiling over or by an object such as an oven glove or a tea towel. *F* will appear in the timer display for a few seconds. If the  sensor is affected, *F* will light up until the object or soiling has been removed. *F* will go out once you have removed the object or cleaned the cooktop and the cooktop will be ready to use again.

Excessive operating time

The safety switch-off mechanism is triggered automatically if a cooking zone is heated for an unusually long period of time. This time depends on the power level selected. If it has been exceeded, the cooking zone switches off and the residual heat indicator for that zone appears. If you switch the cooking zone on and off again, it is ready for operation again.

The cooktop is programmed to safety setting 0 at the factory. If required, you can set a higher safety setting with a shorter maximum operating time (see chart).

Power level*	Maximum operating time [h:min]		
	Safety setting		
	0**	1	2
1	10:00	8:00	5:00
1.	10:00	7:00	4:00
2/2.	5:00	4:00	3:00
3/3.	5:00	3:30	2:00
4/4.	4:00	2:00	1:30
5/5.	4:00	1:30	1:00
6/6.	4:00	1:00	00:30
7/7.	4:00	00:42	00:24
8	4:00	00:30	00:20
8.	4:00	00:30	00:18
9	1:00	00:24	00:10

* The power levels with a dot after the number are only available if the power level range has been extended (see “Power level range”).

** Factory default setting

Safety features

Overheating protection

All the induction coils and cooling elements for the electronics are fitted with an overheating protection mechanism. Before the induction coils and/or cooling elements get too hot, the overheating protection activates in one of the following ways:

Induction coils

- Any Booster function in operation will be switched off.
- The set power level is reduced.
- The cooking zone switches off automatically. *Er* will flash alternately with *44* in the timer display.

You can use the cooking zone again as usual when the fault message has gone out.

Cooling elements

- Any Booster function in operation will be switched off.
- The set power level is reduced.
- The cooking zones switch off automatically.

The affected cooking zones can only be used again as usual once the cooling element has cooled down to a safe level.

The overheating protection may be triggered under the following circumstances:

- The pot or pan being used is empty.
- Fat or oil being heated on a high power level.
- Insufficient ventilation to the underside of the cooktop.
- A hot cooking zone being switched on after an interruption to the power supply.

If, despite removing the cause, the overheating protection mechanism triggers again, contact Miele.

You can adapt the programming of the cooktop to your personal needs. Several settings can be altered in succession.

After accessing programming mode, *P* (Programme) and *C* (Code) will appear in the timer display and 2 cooking zone indicators will light up.

The programme is shown in the left-hand cooking zone display, and the code in the right-hand cooking zone display. From programme stage 10 the numbers appear alternately: *1* flashes alternately with *0*.

Changing the programming

Calling up programming mode

- With the **cooktop switched off** press both the $\text{\textcircled{1}}$ and **II/▶** sensor controls until *PC* appears in the timer display and 2 cooking zone indicators light up.

Setting a programme

- First touch the **left-hand** cooking zone display and then touch the relevant number on the numerical keybank.

A dot will start to flash next to the number.

- While the dot is flashing, press the relevant number(s) on the numerical keybank for the programme number.

Setting the code

- First touch the **right-hand** cooking zone display and then touch the relevant number on the numerical keybank.

A dot will start to flash next to the number.

- While the dot is flashing, press the relevant number(s) on the numerical keybank for the code.

Saving the settings

- Touch the $\text{\textcircled{1}}$ sensor until the indicators go out.

Programming

Programme ¹⁾		Code ²⁾	Settings
1	Demonstration mode	0	Demonstration mode off
		1	Demonstration mode on ³⁾
2	Power management ⁴⁾	0	Off
		1	3680 W
		2	3000 W
		3	2000 W
		4	1000 W
3	Factory settings	0	Do not restore the factory settings
		1	Restore factory settings
4	Number of power levels	0	9 power levels
		1	17 power levels ⁵⁾
6	Confirmation tone when a sensor control is touched	0	Off ⁶⁾
		1	Quiet
		2	Medium
		3	Loud
7	Timer signal tone	0	Off ⁶⁾
		1	Quiet
		2	Medium
		3	Loud
8	System lock	0	System lock can only be activated manually
		1	Activating the system lock automatically
9	Maximum operating time	0	Safety setting 0
		1	Safety setting 1
		2	Safety setting 2
12	Sensor controls reaction speed	0	Slow
		1	Normal
		2	Fast

Programme ¹⁾		Code ²⁾	Settings
15	Permanent pan recognition	0	Not active
		1	Active

1) Programmes not shown here have no allocation.

2) The factory setting is shown in bold.

3) After the cooktop has been switched on, *dE* appears in the timer display for a few seconds.

4) The total output of the cooktop may be reduced in order to meet the local network provider's requirements.

5) The extended power levels are shown with a dot after the number.

6) The keypad tone for the On/Off sensor control cannot be switched off.

Cleaning and care



Risk of burning due to hot surfaces!

The cooking zones will be hot after use.

Switch the cooktop off.

Allow the cooking zones to cool down before cleaning the cooktop.



Risk of damage due to moisture ingress.

The steam from a steam cleaner could reach electrical components and cause a short circuit.

Do not use a steam cleaner to clean the cooktop.

The use of unsuitable cleaning agents can cause the surfaces to discolour or alter. All surfaces are susceptible to scratching.

Remove any residual cleaning agent immediately.

Never use abrasive sponges or cleaning agents.

- Clean the cooktop after every use.
- Dry the cooktop thoroughly after every cleaning to avoid limescale residue.

Unsuitable cleaning agents

To avoid damaging the surfaces of the appliance, do not use:

- washing-up liquid,
- cleaning agents containing soda, alkalines, ammonia, acids or chlorides,
- cleaning agents containing descaling agents,
- stain and rust removers,
- abrasive cleaning agents, e.g. powder cleaners and cream cleaners,
- solvent-based cleaning agents,
- dishwasher cleaner,
- grill and oven cleaners,
- glass cleaning agents,
- hard, abrasive brushes or sponges (e.g. pot scourers), or sponges which have been previously used and still contain abrasive cleaning agents,
- dirt erasers.

Cleaning the ceramic surface

 Risk of damage by pointed objects.

The seal between the cooktop and the worktop could be damaged.

The seal between the ceramic surface and the frame could be damaged.

Do not use pointed objects for cleaning.

Do not use washing-up liquid to clean the appliance. Using washing-up liquid will not remove all soiling and residues. An invisible film can develop that can lead to discolouration of the ceramic glass surface. This discolouration cannot be removed.

Clean the ceramic surface regularly with a proprietary ceramic glass cleaning agent.

- Remove any coarse soiling with a damp cloth and more stubborn soiling with a glass scraper.
- Then clean the ceramic glass surface with the Miele ceramic and stainless steel cooktop cleaner (see “Optional accessories”) or with a proprietary ceramic glass cleaner applied with paper towel or a clean cloth. Do not apply the cleaner while the cooktop is still hot, as this can result in marking. Please follow the cleaning agent manufacturer's instructions.
- Finally wipe the cooktop with a damp cloth and dry it with a soft, dry cloth.

Residues can burn onto the cooktop the next time it is used and cause damage to the glass ceramic surface. Ensure that all cleaner residues are removed.

- **Spots** caused by limescale, water and aluminium residues (spots with a metallic appearance) can be removed using the Miele ceramic and stainless steel cooktop cleaner.

 Risk of burning due to hot surfaces!

The cooking zones are hot during use.

Wear oven gloves when removing residues of sugar, plastic or aluminium foil from a hot cooktop with a glass scraper.

- Should any **sugar, plastic or aluminium foil** spill or fall onto a hot cooking zone while it is in use, first switch off the appliance.
- Then carefully scrape off these residues **immediately** whilst they are still hot, using a shielded scraper blade suitable for use on glass.
- Afterwards, clean the ceramic surface in its cooled state, as described above.

Problem solving guide

With the help of the following guide, minor faults in the performance of the appliance, some of which may result from incorrect operation, can be remedied without contacting Miele. This will save you time and money because you won't need a service call.

Please note that a call-out charge will be applied to unnecessary service visits where the problem could have been rectified as described in these operating instructions.

Problem	Possible cause and remedy
<p>The cooktop or cooking zones do not switch on.</p>	<p>There is no power to the cooktop.</p> <ul style="list-style-type: none"> ■ Check if the circuit breaker has tripped. Contact an electrician or Miele (for the minimum fuse rating, see data plate). <hr/> <p>There may be a technical fault.</p> <ul style="list-style-type: none"> ■ Disconnect the appliance from the mains electricity supply for approx. 1 minute. To do this: <ul style="list-style-type: none"> – switch off at the wall socket and withdraw the plug, or – switch off at the residual current device. ■ If, after switching the circuit breaker or residual current device back on, the appliance will still not switch on, contact a qualified electrician or Miele.
<p>A smell and vapours are given off when the new appliance is being used.</p>	<p>The metal components have a protective coating. When the appliance is used for the first time, this causes a smell and possibly also vapour. The material from which the induction coils are made also gives off a smell in the first few hours of operation. This smell will be less noticeable with each subsequent use before dissipating completely. The smell and any vapours given off do not indicate a faulty connection or appliance and they are not hazardous to health.</p>
<p>In the cooking zone display, the \cup symbol will flash alternately with the selected power level or \bar{H}.</p>	<p>An unsuitable pan has been placed on the cooktop.</p> <ul style="list-style-type: none"> ■ Use suitable pans (see “Induction - Cookware”).

Problem solving guide

Problem	Possible cause and remedy
<p>After the cooktop has been switched on <i>LC</i> appears in the timer display for a few seconds.</p>	<p>The system lock or safety lock is activated.</p> <ul style="list-style-type: none"> ■ Deactivate the system lock or safety lock (see “Safety features - System lock / Safety lock”).
<p><i>F</i> flashes in the timer display and the cooktop switches off automatically.</p>	<p>One or more of the sensor controls are covered, e.g. by finger contact, food boiling over or an object.</p> <ul style="list-style-type: none"> ■ Clean off any dirt and/or remove the object (see “Safety features - Safety switch-off”).
<p>After the cooktop has been switched on <i>dE</i> appears in the timer display for a few seconds. The cooking zones do not heat up.</p>	<p>The cooktop is in Demonstration mode.</p> <ul style="list-style-type: none"> ■ Touch the 0 and 2 sensor controls at the same time until <i>dE</i> flashes alternately with <i>DF</i> in the timer display.
<p>A cooking zone switches itself off automatically.</p>	<p>It has been operated for too long.</p> <ul style="list-style-type: none"> ■ You can use the cooking zone again by switching it back on (see “Safety features - Safety switch-off”).
<p>A cooking zone or the whole cooktop switches off automatically.</p>	<p>The overheating protection mechanism has been activated.</p> <ul style="list-style-type: none"> ■ See “Safety features - Overheating protection”.
<p>The Booster has automatically switched off early.</p>	<p>The overheating protection mechanism has been activated.</p> <ul style="list-style-type: none"> ■ See “Safety features - Overheating protection”.
<p>A cooking zone is not working in the usual way on the power level selected.</p>	<p>The overheating protection mechanism has been activated.</p> <ul style="list-style-type: none"> ■ See “Safety features - Overheating protection”.
<p>Power level 9 is automatically reduced if you select power level 9 on two linked cooking zones or extended zones at the same time.</p>	<p>Operating both zones at power level 9 would exceed the permitted maximum power for the cooktop.</p> <ul style="list-style-type: none"> ■ Use another cooking zone which is not linked.

Problem solving guide

Problem	Possible cause and remedy
<p>The food in the pan hardly heats up or does not heat up at all when the Auto heat-up function is switched on.</p>	<p>There is too much food in the pan.</p> <ul style="list-style-type: none"> ■ Start cooking at the highest power level and then turn down to a lower one manually later on.
	<p>The pan is not conducting heat properly.</p> <ul style="list-style-type: none"> ■ Use a different pan which is better able to conduct heat.
<p>A noise can be heard after the appliance is switched off.</p>	<p>The fan will continue running until the cooktop has cooled down. It will then switch itself off automatically.</p>
<p><i>Er</i> alternating with numbers flashes in the timer display.</p>	<p><i>Er44</i></p> <p>The overheating protection mechanism has been activated.</p> <ul style="list-style-type: none"> ■ See “Safety features - Overheating protection”.
	<p><i>Er47, Err48 or Er49</i></p> <p>The fan is blocked or defective.</p> <ul style="list-style-type: none"> ■ Make sure the fan has not been blocked by an object. ■ Remove the obstruction. ■ If this fault code continues to appear in the display, contact Miele.
	<p><i>Er</i> and other numbers</p> <p>There is a fault in the electronic module.</p> <ul style="list-style-type: none"> ■ Interrupt the power supply to the cooktop for approx. 1 minute. ■ If the problem persists after power is restored, please contact Miele.

Miele offers a range of useful accessories, as well as cleaning and conditioning products for your appliance.

These products can be ordered from the Miele online shop.

They can also be ordered directly from Miele (see end of this booklet for contact details).

Saucepans and frying pans

Miele offers a wide range of pans which are perfect for Miele cooktops. Please refer to the Miele website for more details on individual products.

- Pans in various sizes
- Non-stick pan
- Wok
- Gourmet oven dishes

Cleaning and care products

Original Miele ceramic and stainless steel cleaner 250 ml



Removes heavy soiling, limescale deposits and aluminium residues.

Original Miele all purpose microfibre cloth

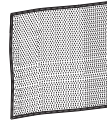

Removes finger marks and light soiling.

Service

Contact in case of fault

In the event of any faults which you cannot remedy yourself, please contact Miele.

Contact information for Miele can be found at the end of this booklet.

Please quote the model and serial number of your appliance when contacting Miele. This information can be found on the data plate.

Data plate

Adhere the extra data plate supplied with the appliance in the space below. Make sure that the model number matches the one specified on the back cover of these operating and installation instructions.

Warranty

The manufacturer's warranty for this appliance is 2 years.

For further information, please refer to your warranty booklet.

Safety instructions for installation

 Risk of damage from incorrect installation.
Incorrect installation can cause damage to the cooktop.
The cooktop must only be installed by a qualified person.

 Danger of electric shock!
Incorrect connection to the power supply may result in an electric shock.
The cooktop must be connected to the power supply by a qualified electrician.

 Damage from falling objects.
Take care not to damage the cooktop when fitting wall units or a rangehood above it.
Fit the wall units and the rangehood before the cooktop.

- ▶ The veneer or laminate coatings of worktops (or adjacent kitchen units) must be treated with 100 °C heat-resistant adhesive which will not dissolve or distort. Any splashbacks must be of heat-resistant material.
- ▶ The cooktop must not be installed over a fridge, fridge-freezer, freezer, dishwasher, washing machine, washer-dryer or tumble dryer.
- ▶ This cooktop must not be installed above ovens unless these have a built-in cooling fan.
- ▶ After installation, ensure that nothing can come into contact with the connection cable and that it is without hindrance.
- ▶ The connection cable may not come into contact with any moving kitchen component (e.g. a drawer) or be subject to mechanical obstruction which could damage it.
- ▶ Carefully observe the safety clearances listed on the following pages.

Installation

Safety distances

Safety distance above the cooktop

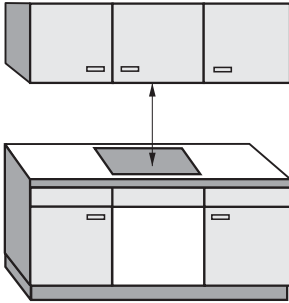

The safety distance specified by the manufacturer of the rangehood must be maintained between the cooktop and the rangehood above it.

If the manufacturer's instructions are not available for the rangehood, a minimum safety distance of 600 mm must be maintained.

For any flammable objects, e.g. utensil rails, wall units etc., a minimum safety distance of 600 mm must be maintained between these objects and the highest part of the cooktop below.

When two or more appliances which have different safety distances are installed together below a rangehood, observe the greatest specified safety distance.

Safety distances to the sides and back of the appliance

The minimum distance shown below must be maintained between the back edge of the cooktop and a tall unit or wall.

Ideally the cooktop should be installed with plenty of space on either side. There may be a wall at the rear or a tall unit or wall on one side (right or left), taking into account the distances below. On the other side, however, no tall unit or wall should stand closer than 300 mm to the edge of the cooktop. Before installing the cooktop, check that the below clearance requirements are met.

Minimum horizontal distance from the **back edge** of the cooktop to a combustible surface:
50 mm.

Minimum horizontal distance from the **right edge** of the cooktop to a combustible surface:
50 mm.

Minimum horizontal distance from the **left edge** of the cooktop to a combustible surface:
50 mm.

Minimum safety distance underneath the cooktop

To ensure sufficient ventilation to the cooktop, a minimum distance must be left between the underside of the cooktop and any oven, interim shelf or drawer.

The minimum gap between the underside of the cooktop and

- the top edge of an oven: 15 mm
- the top edge of an interim shelf: 15 mm
- the top edge of a drawer: 5 mm
- the base of a drawer: 75 mm

Interim shelf

It is not necessary to fit an interim shelf underneath the cooktop but one may be fitted if you wish.

Leave a gap of 10 mm at the back between the cabinet and the interim shelf to **accommodate the power cable**.

A gap of 20 mm is recommended at the front between the cabinet and interim shelf for better **ventilation** of the cooktop.

Installation

Installation notes

Seal between the cooktop and the worktop

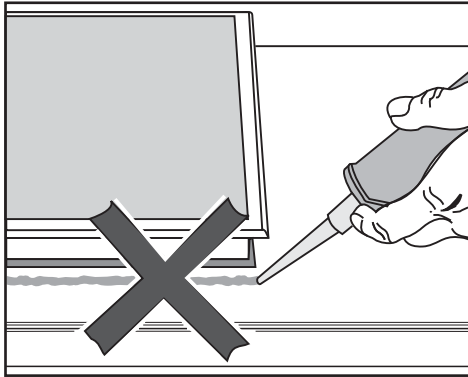

 Damage caused by incorrect installation.

Using sealant under the cooktop could result in damage to the cooktop and the worktop if the cooktop ever needs to be removed for servicing.

Do not use sealant between the cooktop and the worktop.

The sealing strip under the edge of the cooktop provides a sufficient seal for the worktop.

Tiled worktop

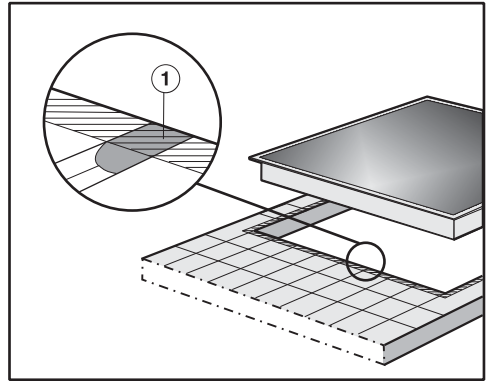

Grout lines ① and the hatched area underneath the cooktop frame must be smooth and even. If they are not, the cooktop will not sit flush with the worktop and the sealing strip underneath the cooktop will not provide a good seal between the cooktop and the worktop.

Sealing strip

Dismantling the cooktop for service purposes may damage the sealing strip underneath the edge of the cooktop.

Always replace the sealing strip before reinstalling the cooktop.

Installation dimensions

All dimensions in this instruction booklet are given in mm.

KM 7200 FR

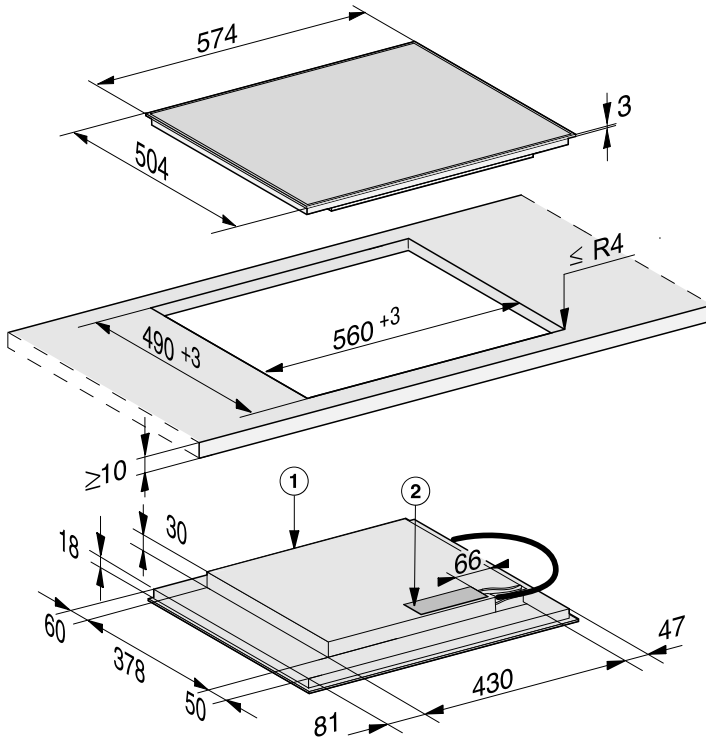

① Front

② Mains connection box

The mains connection cable (L = 1,440 mm) is supplied loose

Installation

KM 7201 FR

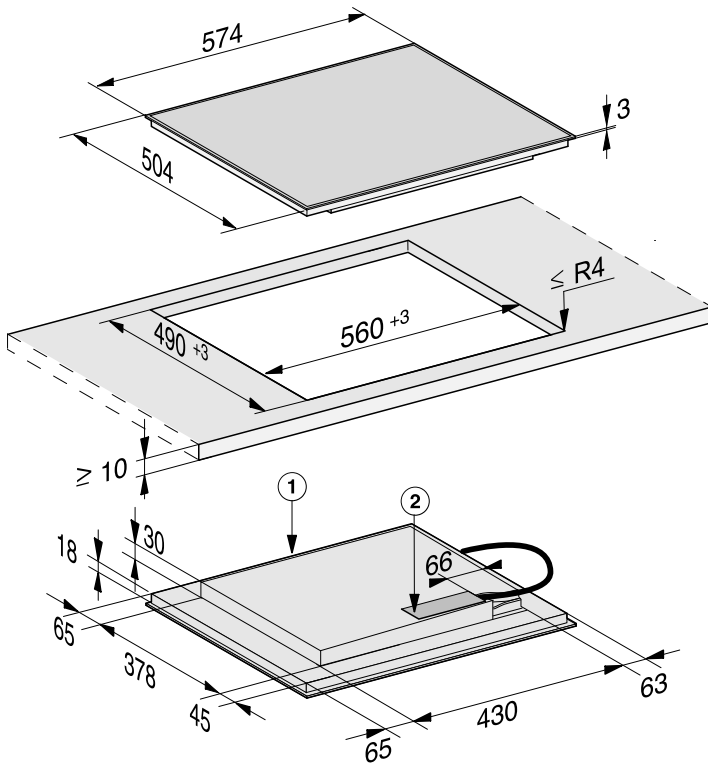

① Front

② Mains connection box

The mains connection cable (L = 1,440 mm) is supplied loose

Installation

- Create the worktop cut-out.
Remember to maintain the minimum safety distances (see “Installation – Safety distances”).
- Seal the cut surfaces of **wooden worktops** with a suitable sealant to avoid swelling caused by moisture. The sealant must be heat-resistant.

Make sure the sealant does not come into contact with the top surface of the worktop.

- Attach the sealing strip provided underneath the edge of the cooktop. Do not apply the sealing strip under tension.



Risk of damage from incorrect connection.

The electronics of the cooktop may be damaged if a short-circuit occurs. The mains connection cable must be connected to the cooktop by a qualified electrician.

- Connect the mains connection cable by following the instructions in the wiring diagram on the cooktop (see “Installation – Electrical connection”).
- Feed the mains connection cable down through the worktop cut-out.
- Place the cooktop centrally in the cut-out. When doing this make sure that the seal of the appliance sits flush with the worktop on all sides. This is important to ensure an effective seal with the worktop.

If the seal does not meet the worktop correctly on the corners, the corner radius ($\leq R4$) can be carefully scribed to suit.

- Connect the cooktop to the electricity supply (see “Installation – Electrical connection”).
- Check that the cooktop works.

Installation

Electrical connection

 Risk of damage from incorrect connection.

Incorrect installation, maintenance and repairs can be dangerous to users.

Miele cannot be held liable for damage or injury caused by incorrect or unauthorised installation, maintenance or repair work, or by an inadequate or faulty on-site earthing system (e.g. electric shock).

All electrical work must be carried out by a suitably qualified and competent electrician, in strict accordance with current national and local safety regulations, and any additional regulations of the local electricity provider.

After installation, ensure that all electrical components are shielded and cannot be accessed by users.

Total power output

See data plate.

Connection data

The connection data is quoted on the data plate. Please ensure this information matches the household mains supply.

Please see the wiring diagrams for connection.

Residual current device

For extra safety, it is advisable to protect the appliance with a suitable residual current device (RCD) with a trip range of 30 mA.

Disconnecting devices

Connection must be made via a suitable isolator switch which provides disconnection on all poles and which complies with national and local safety regulations. When switched off there must be an all-pole contact gap of at least 3 mm in the isolator switch. The isolator switch must be easily accessible after the appliance has been built in.

Mains connection cable

The cooktop must be connected to the electrical supply with a special connection cable, type H 05 VV-F (PVC insulated) with a suitable diameter.

Please see the wiring diagram for connection.

See the data plate on the cooktop for the correct voltage and frequency.

The connection cable comes supplied with a ferrite sleeve attached. This end must be fitted to the terminal box of the cooktop. If using a different connection cable, with the exception of the earth conductor, all other single conductors of the power cable must be fed through the opening of the ferrite sleeve before attaching them to the connection terminals.

Wiring diagram

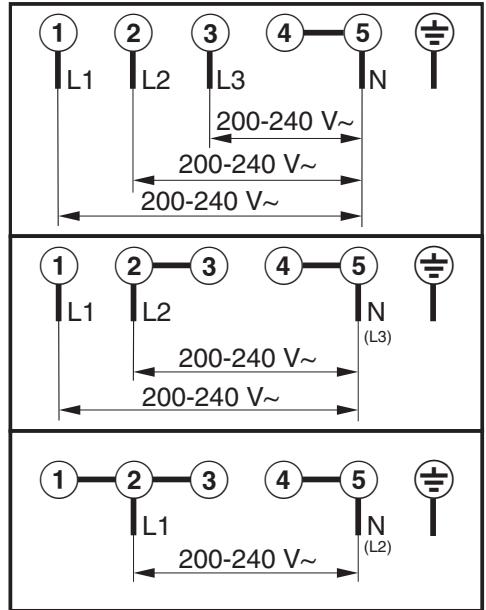

Replacing the mains connection cable



Danger of electric shock!

Incorrect connection to the electricity supply may result in an electric shock.

The mains connection cable must only be replaced in accordance with current local and national safety regulations.

When replacing the mains connection cable, it must be replaced with cable type H 05 VV-F by a Miele authorised service technician or a suitably qualified and competent electrician in order to avoid a hazard. These cables are available from Miele.

Miele

Miele Australia Pty. Ltd.

ACN 005 635 398
ABN 96 005 635 398

**Miele Experience Centre and
Head Office Melbourne:**

1 Gilbert Park Drive
Knoxfield, VIC 3180

Miele Experience Centre South Melbourne:

206-210 Coventry Street
South Melbourne, VIC 3205

Miele Experience Centre and Office Sydney:

3 Skyline Place
Frenchs Forest, NSW 2086

Miele Experience Centre and Office Brisbane:

Tenancy 4C, 63 Skyring Terrace
Newstead, QLD 4006

Miele Experience Centre Gold Coast:

131 Ferry Road
Southport, QLD 4215

Miele Experience Centre and Office Adelaide:

83-85 Sir Donald Bradman Drive
Hilton, SA 5033

Miele Experience Centre and Office Perth:

205-207 Stirling Highway
Claremont, WA 6010

1300 464 353 (1300 4 MIELE)

www.miele.com.au

Miele New Zealand Limited

IRD 98 463 631

Head Office:

Level 2, 10 College Hill
Freemans Bay, Auckland 1011

**Miele Experience Centre
Auckland:**

8 College Hill
Freemans Bay, Auckland 1011

**Miele Experience Centre
Wellington:**

183 Featherston Street
Wellington 6011

0800 464 353 (0800 4 MIELE)

www.miele.co.nz

Miele Global Headquarters**Germany****Miele & Cie. KG**

Carl-Miele-Straße 29
33332 Gütersloh

Federal Republic of Germany

KM 7200 FR, KM 7201 FR, KM 7210 FR, KM 7262 FR

en-AU, NZ

M.-Nr. 11 274 100 / 01