

# BSP 250/251

Combi-steam oven

## Table of contents

<b>Intended use</b>	<b>4</b>	<b>Time-setting options</b>	<b>18</b>
<b>Important safety information</b>	<b>5</b>	Calling up the timer menu	18
<b>Causes of damage</b>	<b>7</b>	Timer	18
<b>Environmental protection</b>	<b>7</b>	Stopwatch	19
Saving energy	7	Cooking time	19
Environmentally-friendly disposal	7	End of cooking time	20
<b>Familiarising yourself with your appliance</b>	<b>8</b>	<b>Long-term timer</b>	<b>21</b>
Steam oven	8	Setting the long-term timer	21
Fresh water tank and used water tank	8	<b>Childproof lock</b>	<b>22</b>
Grease filter	9	Activate the child lock	22
Display and operating controls	9	Deactivating the child lock	22
Symbols	9	<b>Automatic programmes</b>	<b>22</b>
Colours and display	9	Information on the settings	22
Standby	10	Selecting a dish	23
Activating the appliance	10	Applying settings for a dish	23
Additional information <b>i</b> and <b>i</b> <sup>®</sup>	10	Calling up the last automatic programmes used	23
Cooling fan	10	<b>Individual recipes</b>	<b>24</b>
Drying the cooking compartment	10	Recording a recipe	24
Function selector positions	11	Programming a recipe	24
Accessories	13	Entering names	25
Special accessories	13	Starting recipes	25
<b>Before using for the first time</b>	<b>14</b>	Change recipe	25
Setting the language	14	Deleting recipes	25
Setting the time format	14	<b>Core temperature probe</b>	<b>26</b>
Setting the clock	14	Inserting the core temperature probe into the food	26
Setting the date format	14	Setting the core temperature	27
Setting the date	14	Suggested values for the core temperature	28
Setting the temperature unit	14	<b>Home Connect</b>	<b>29</b>
Setting the water hardness	14	Setting up	29
Ending initial set-up	14	Remote Start	30
Grease filter	14	Home Connect settings	30
Cleaning the door panel	15	Remote diagnostics	31
Cleaning accessories	15	About data protection	31
Heating up the appliance	15	Declaration of Conformity	31
<b>Activating the appliance</b>	<b>15</b>	<b>Basic settings</b>	<b>32</b>
Standby	15	<b>Cleaning and maintenance</b>	<b>34</b>
Activating the appliance	15	Cleaning agents	34
<b>Operating the appliance</b>	<b>16</b>	Cleaning aid	35
Filling the water tank	16	Drying programme	35
Cooking compartment	16	Descaling programme	36
Inserting accessories	17	Removing the wire racks	37
Switching on	17	<b>Trouble shooting</b>	<b>38</b>
Switching off	17	Power cut	39
Steam injection	17	Demo mode	39
After every use	17		
Safety shut-off	18		

<b>After-sales service</b>	<b>40</b>
E number and FD number	40
<b>Tables and tips</b>	<b>40</b>
Vegetables	41
Fish	42
Fish – low-temperature steaming	42
Meat – cooking at higher temperatures	43
Meat/poultry – low-temperature cooking	44
Poultry	45
Sous-vide cooking	46
Grilling	49
Side dishes	50
Desserts	50
Miscellaneous	51
Baked items	51
Dough proving (leaving to rise)	53
Regenerating (reheating)	53
Defrosting	54
Preserving	54
Extracting juice (soft fruit)	55
Preparing yoghurt	55
Preparing bulky food	55
Acrylamide in foodstuffs	55

Additional information on products, accessories, replacement parts and services can be found at [www.gaggenau.com](http://www.gaggenau.com) and in the online shop [www.gaggenau.com/zz/store](http://www.gaggenau.com/zz/store)

## Intended use

Read these instructions carefully. Only then will you be able to operate your appliance safely and correctly. Retain the instruction manual and installation instructions for future use or for subsequent owners.

This appliance is only intended to be fully fitted in a kitchen. Observe the special installation instructions.

Check the appliance for damage after unpacking it. Do not connect the appliance if it has been damaged in transport.

Only a licensed professional may connect appliances without plugs. Damage caused by incorrect connection is not covered under warranty.

This appliance is intended for domestic use only. The appliance must only be used for the preparation of food and drink. The appliance must be supervised during operation. Only use this appliance indoors.

This appliance is intended for use up to a maximum height of 4000 metres above sea level.

This appliance may be used by children over the age of 8 years old and by persons with reduced physical, sensory or mental capabilities or by persons with a lack of experience or knowledge if they are supervised or are instructed by a person responsible for their safety how to use the appliance safely and have understood the associated hazards.

Children must not play with, on, or around the appliance. Children must not clean the appliance or carry out general maintenance unless they are at least 15 years old and are being supervised.

Keep children below the age of 8 years old at a safe distance from the appliance and power cable.

Always slide accessories into the cooking compartment correctly. See description of accessories in the instruction manual.

## **⚠ Important safety information**

### **⚠ Warning – Risk of fire!**

- Combustible items stored in the cooking compartment may catch fire. Never store combustible items in the cooking compartment. Never open the appliance door if there is smoke inside. Switch off the appliance and unplug it from the mains or switch off the circuit breaker in the fuse box.
- A draught is created when the appliance door is opened. Greaseproof paper may come into contact with the heating element and catch fire. Do not place greaseproof paper loosely over accessories during preheating. Always weight down the greaseproof paper with a dish or a baking tin. Only cover the surface required with greaseproof paper. Greaseproof paper must not protrude over the accessories.

### **⚠ Warning – Risk of burns!**

- The appliance becomes very hot. Never touch the interior surfaces of the cooking compartment or the heating elements. Always allow the appliance to cool down. Keep children at a safe distance.
- Accessories and ovenware become very hot. Always use oven gloves to remove accessories or ovenware from the cooking compartment.
- Alcoholic vapours may catch fire in the hot cooking compartment. Never prepare food containing large quantities of drinks with a high alcohol content. Only use small quantities of drinks with a high alcohol content. Open the appliance door with care.
- Hot steam may escape during operation. Do not touch the ventilation openings. Keep children away.

### **⚠ Warning – Risk of scalding!**

- When you open the appliance door, hot steam can escape. Steam may not be visible, depending on its temperature. When opening, do not stand too close to the appliance. Open the appliance door carefully. Keep children away.
- Hot liquid may spill over the sides of the accessory when it is removed from the cooking compartment. Remove hot accessories with care and always wear oven gloves.

### **⚠ Warning – Risk of electric shock!**

- Incorrect repairs are dangerous. Repairs may only be carried out and damaged power cables replaced by one of our trained after-sales technicians. If the appliance is defective, unplug the appliance from the mains or switch off the circuit breaker in the fuse box. Contact the after-sales service.
- The cable insulation on electrical appliances may melt when touching hot parts of the appliance. Never bring electrical appliance cables into contact with hot parts of the appliance.
- Do not use any high-pressure cleaners or steam cleaners, which can result in an electric shock.
- A defective appliance may cause electric shock. Never switch on a defective appliance. Unplug the appliance from the mains or switch off the circuit breaker in the fuse box. Contact the after-sales service.
- The insulation of an incompatible meat probe may be damaged. Only use the meat probe which is recommended for this appliance.

**⚠ Warning – Risk of injury!**

- Descaling tablets may cause chemical burns in the mouth, throat, eyes and on the skin. Follow the safety instructions on the packaging of the descaling tablets. Avoid the skin coming into contact with the descaling tablets. Keep children away from descaling tablets.
- The descaling solution may cause chemical burns in the mouth, throat and eyes or on the skin. Avoid the skin coming into contact with the descaling solution. Keep children away from descaling solution. Do not drink the descaling solution. The descaling solution must not come into contact with food. Rinse out the water tank thoroughly before you next use the appliance.

**⚠ Warning – Risk of injury!**

The light emitted by LED lights is very dazzling, and can damage the eyes (risk group 1). Do not look directly into the switched on LED lights for longer than 100 seconds.

## Causes of damage

### Caution!

- Do not place anything directly on the cooking compartment floor. Do not cover it with aluminium foil. A build-up of heat may damage the appliance. The cooking compartment floor must always be kept clear. Always place ovenware in a perforated cooking container or on a wire rack.
- Aluminium foil in the cooking compartment must not come into contact with the door panel. This could cause permanent discolouration of the door panel.
- We recommend you use a mineral water low in chloride and without added carbonic acid if your tap water contains large amounts of chloride (>40 mg/l). You can inquire with your local water supply company to obtain information about your tap water.
- Ovenware must be heat and steam resistant. Silicone baking tins are not suitable for combined operation with steam.
- Only use original accessories in the cooking compartment. Do not use any enamelled baking trays or grill trays. Rusting material (e.g. serving plates, cutlery) may lead to corrosion in the cooking compartment.
- Use original small parts (e.g. knurled nuts) only. Order small parts from our after-sales service if these should be lost.
- Dripping liquids: When steaming with a perforated cooking container, always insert the solid cooking container underneath. This catches the liquid that drips down.
- Do not store moist food in the closed cooking compartment for long periods. It can lead to corrosion in the cooking compartment.
- Salt, spicy sauces (e.g. ketchup or mustard) or salted dishes (e.g. cured roast) contain chloride and acids. These corrode the surfaces of stainless steel. Always remove residues immediately.
- Fruit juice may leave stains in the cooking compartment. Always remove fruit juice immediately and wipe the cooking compartment with a moist and dry cloth.
- Improper care of the appliance may lead to corrosion in the cooking compartment. Refer to the care and cleaning instructions in the instruction manual. Clean the cooking compartment each time you use it as soon as the appliance has cooled down. After cleaning the cooking compartment, use the drying programme to dry it.
- Do not detach the door seal. The appliance door will no longer close properly if the door seal is damaged. The fronts of adjacent units could be damaged. Have the door seal replaced.

## Environmental protection

Your new appliance is particularly energy-efficient. Here you can find tips on how to save even more energy when using the appliance, and how to dispose of your appliance properly.

### Saving energy

- Open the appliance door as little as possible while cooking.
- Use dark, black lacquered or enamelled baking tins for baking. They absorb the heat particularly well.
- It is best to bake several cakes one after the other. The oven will still be hot. This reduces the baking time for the second cake. You can also place two loaf tins next to each other.
- For longer cooking times, you can switch off the steam oven 10 minutes before the end of the cooking time and you can use the residual heat to finish cooking.
- When steaming, you can cook simultaneously on several levels. If dishes require different cooking times, insert the dishes that require the longest time first.

### Environmentally-friendly disposal

Dispose of packaging in an environmentally-friendly manner.



This appliance is labelled in accordance with European Directive 2012/19/EU concerning used electrical and electronic appliances (waste electrical and electronic equipment - WEEE). The guideline determines the framework for the return and recycling of used appliances as applicable throughout the EU.

---

## Familiarising yourself with your appliance

---

Use this section to familiarise yourself with your new appliance. The control panel and the individual operating controls are explained. You will find information on the cooking compartment and the accessories.

### Steam oven

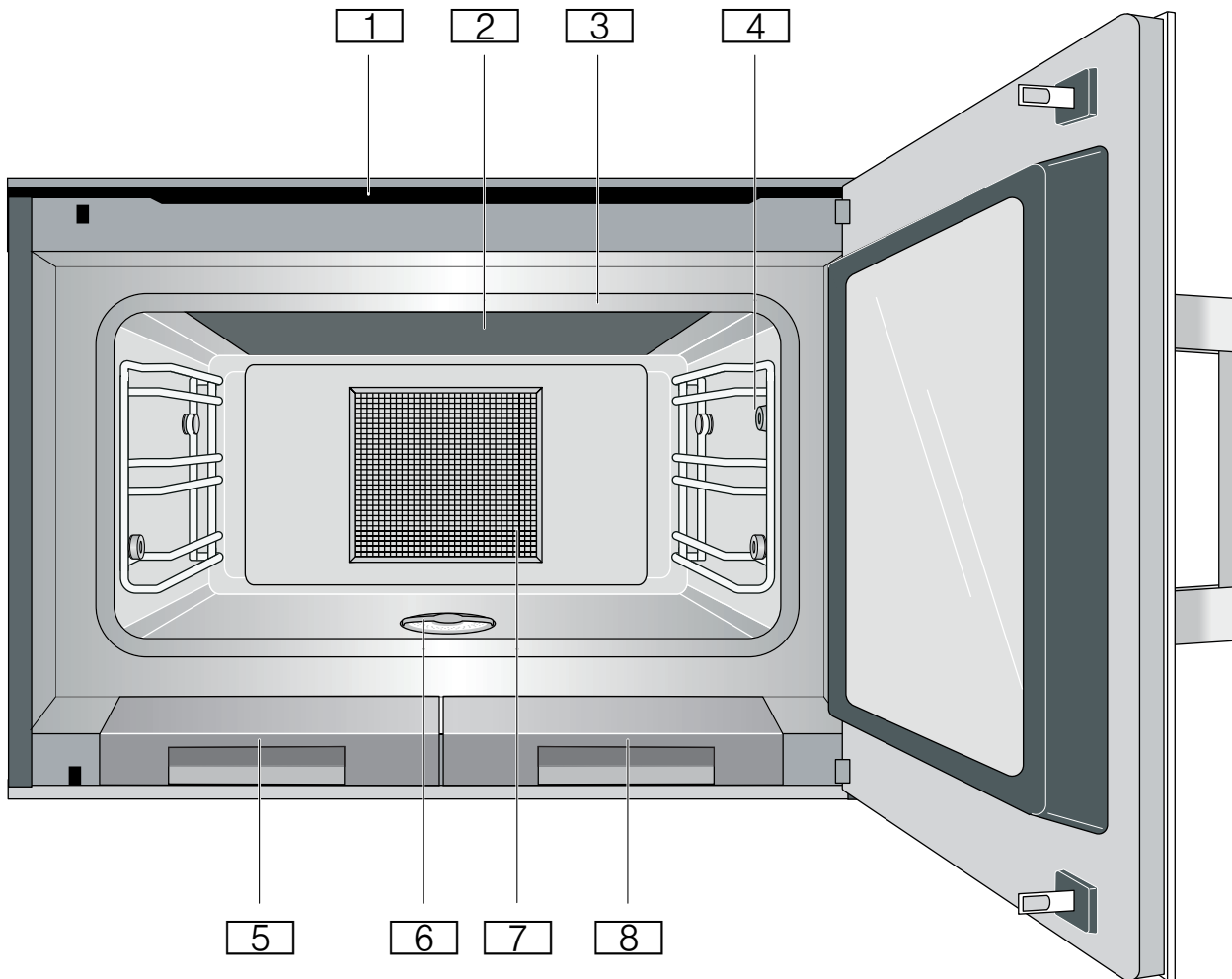

- 1 Ventilation slots
- 2 Glass ceramic grilling surface
- 3 Door seal
- 4 Connection socket for core temperature probe
- 5 Used water tank
- 6 Strainer filter
- 7 Grease filter
- 8 Fresh water tank

### Fresh water tank and used water tank

Your appliance is equipped with a fresh water tank and a used water tank. If you open the appliance door, you can see the used water tank on the left and the fresh water tank on the right

Before using the appliance, always fill the fresh water tank. → "Filling the water tank" on page 16

The fresh water tank has a capacity of approx. 1.7 litres.

After using the appliance with a steam function, allow it to cool down and empty the used water tank.



## Grease filter

Your appliance is equipped with a grease filter. The grease filter prevents the components of the appliance becoming soiled with grease. Leave the grease filter in the cooking compartment for all applications.

## Display and operating controls

These instructions are valid for different versions of the appliance. There may be minor differences depending on the appliance model.

All versions of the appliance are operated in an identical manner.

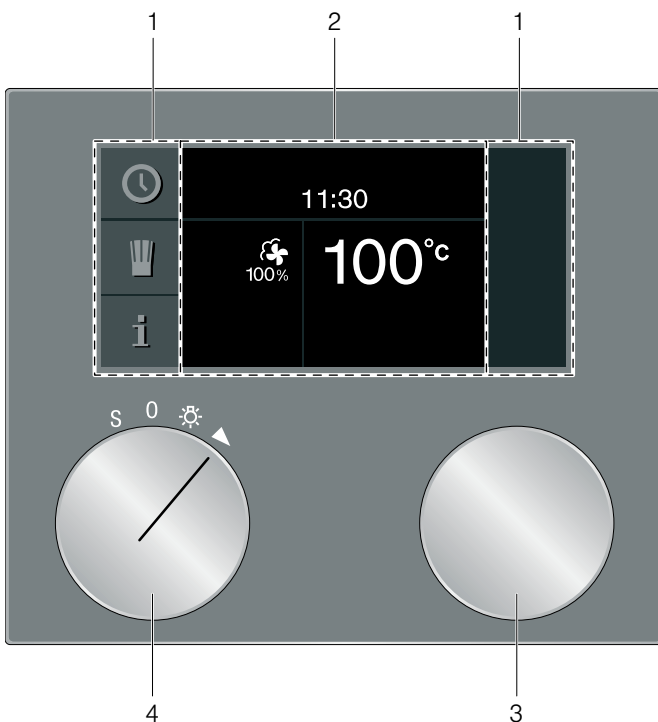

1	Control panel	These areas are touch sensitive. Touch a symbol to select the corresponding function.
2	Display	The display shows, for example, current settings and options.
3	Rotary selector	You can use the rotary selector to set the temperature and to make further settings.
4	Function selector	The function selector is used to select the type of heating, the cleaning function or the basic settings.

## Symbols

Symbol	Function
▶	Start
■	Stop
	Pause/End
✕	Cancel
⊖	Delete
✓	Confirm/save settings
>	Selection arrow
i	Call up additional information
⏩	Rapid heating with status indicator
🍷	Calling up automatic programmes or individual recipes
rec	Record menu
↶	Edit settings
>A	Enter name
✖	Delete letters
🔒	Child lock
🕒	Call up timer menu
🕒	Call up long-term timer
🔪	Demo mode
🌡	Call up core temperature probe
🌫	Misting start
🌫	Misting stop
📶	Network connection (Home Connect)

## Colours and display

### Colours

The different colours are used to guide the user in the relevant setting situations.

Orange	Initial settings
	Main functions
Blue	Basic settings
	Cleaning
White	Values which can be set

## Appearance

Depending on the situation, the appearance of symbols, values or the entire display changes.

Zoom	The setting that you are changing will appear larger on the display.  If you have set a time and it is about to run out, it will appear larger on the display just before it runs out (e.g. 60 seconds before the end, if you have set the timer).
Pared-down display	After a short while, the amount of information shown on the display will be reduced and only the most important information will remain. This function is pre-set and can be changed in the basic settings.

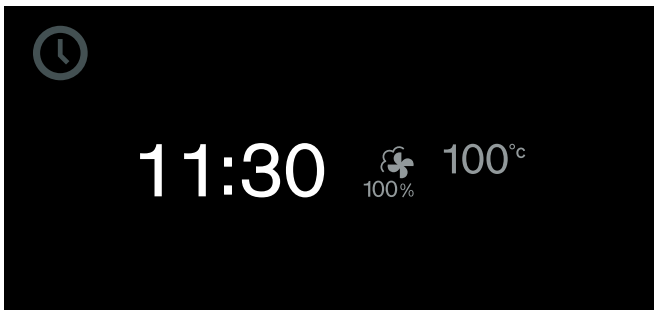

## Standby

The appliance switches to standby mode if no function is set or the childproof lock is activated.

The brightness of the control panel is dimmed in standby mode.

### Notes

- Different things can be displayed in standby mode. The default setting is the GAGGENAU logo and the time.
- The brightness of the display depends on the vertical viewing angle.
- You can change the display and the brightness at any time in the basic settings.

## Activating the appliance

To exit standby mode, you can either

- Turn the function selector,
- Touch a control panel,
- Open or close the door.

You can now set the desired function. You can read about how to set functions in the respective chapters.

### Notes

- When "Standby screen = off" is selected in the basic settings, you must turn the function selector to exit standby mode.
- The appliance returns to the standby screen if you have not made any settings for a long time after activation.
- When the door is open, the interior lighting switches off after a short time.

## Additional information **i** and **i**<sup>!</sup>

By touching the **i** symbol, you can call up additional information. For example, information on the type of heating set or on the current temperature of the cooking compartment.

**Note:** During continuous operation after heating up, slight deviations in temperature are normal.

The **i**<sup>!</sup> symbol appears for important information and indicates that an action is required. Important information on safety and operating status is also occasionally displayed automatically. These messages disappear automatically after a few seconds or must be confirmed with ✓.

With Home Connect messages, the Home Connect status additionally appears in the **i**<sup>!</sup>. You will find more information about this in the section entitled → "Home Connect" on page 29.

## Cooling fan

Your appliance has a cooling fan. The cooling fan switches on when the appliance is in operation. The hot air escapes above the door.

After removing your food from the appliance, keep the door closed until the appliance has cooled down. The appliance door must not be left half open as this may damage adjacent kitchen units. The cooling fan continues running for a certain period after the appliance has stopped heating; afterwards, it switches itself off automatically.

### Caution!







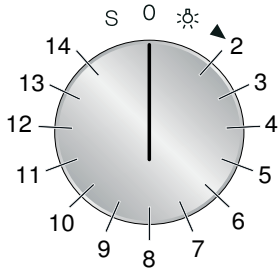

Do not cover the ventilation slots. Otherwise, the appliance may overheat.

## Drying the cooking compartment









After operation with a steam function, the cooking compartment is damp. The cooling fan and the fan wheel on the back wall of the cooking compartment continue to run for a while after the appliance is switched off and then switch off automatically. This may take up to 95 minutes. The appliance door must remain closed while the cooking compartment is being dried.

## Function selector positions



Position	Function/heating function	Temperature	Application
0	"Off" position		
	Light		Switch on the interior lighting. Access to other functions, e.g. automatic programmes, individual recipes, remote start (Home Connect).
2	 Hot air + 100% humidity	30 - 230 °C Default temperature 100 °C	Steaming at 70 - 100 °C: For vegetables, fish and side dishes. The food is completely enveloped by steam. Combination mode at 120 - 230 °C: For puff pastry, bread and bread rolls. Hot air and steam are combined.
3	 Hot air + 80% humidity	30 - 230 °C Default temperature 170 °C	Combination mode: For puff pastry, meat and poultry. Hot air and steam are combined.
4	 Hot air + 60% humidity	30 - 230 °C Default temperature 170 °C	Combination mode: For yeast-risen baked goods and bread. Hot air and steam are combined. Dough proving: For yeast dough and sourdough. Dough will rise considerably more quickly than at room temperature. Hot air and steam are combined so that the surface of the dough does not dry out. The optimal temperature setting for yeast dough is 38 °C.
5	 Hot air + 30% humidity*	30 - 230 °C Default temperature 170 °C	Cooking without added liquid: For baked goods. With this setting, no steam is generated. Any moisture escaping from the food remains in the cooking compartment and prevents the food from drying out.
6	 Hot air + 0% humidity	30 - 230 °C Default temperature 170 °C	Hot air: For cakes, biscuits and bakes. The fan in the back panel of the oven distributes the heat evenly throughout the cooking compartment.
7	 Low-temperature cooking	30 - 90 °C Default temperature 70 °C	Low-temperature cooking for meat. Gentle slow cooking for a particularly tender result.
8	 Sous-vide cooking	50 - 95 °C Default temperature 60 °C	Cooking under a vacuum at low temperatures between 50 and 95 °C and 100% steam: Suitable for meat, fish, vegetables and desserts. A vacuum-sealing machine uses heat to hermetically seal the food in a special heat-resistant cooking bag. The protective envelope retains the nutrients and flavours.
9	 Full surface grill setting 1 + humidity	30 - 230 °C Default temperature 170 °C	Grill mode with humidity: For bakes and gratins.

\* Heating function used to determine the energy efficiency class in accordance with EN 60350-1.

Position	Function/heating function	Temperature	Application
10	 Full surface grill setting 2 + humidity	30 - 230 °C Default temperature 170 °C	Grill mode with humidity: For stuffed vegetables. The grill output is increased.
11	 Full surface grill + air recirculation	30 - 230 °C Default temperature 230 °C	For au gratin dishes at the end of the cooking time at 230 °C. For grilling vegetable skewers and prawn skewers at 180 °C.
12	 Dough proving	30 - 50 °C Default temperature 38 °C	Proving: For yeast dough and sourdough. The dough rises considerably more quickly than at room temperature. Hot air and steam are combined so that the surface of the dough does not dry out. The optimal temperature setting for yeast dough is 38 °C.
13	 Defrosting	40 - 60 °C Default temperature 45 °C	For vegetables, meat, fish and fruit. The moisture transfers the heat to the food, gently defrosting it without impairing its quality. The food does not dry out or lose its shape.
14	 Reheating	60 - 180 °C Default temperature 120 °C	For cooked food and baked goods. Cooked food is gently reheated without affecting its quality. The steam ensures that the food does not dry out. Reheat plated meals at 120 °C and baked goods at 180 °C.
S	 Basic settings		Your appliance can be adjusted to your requirements in the basic settings.
	 Cleaning aid		You can use the cleaning aid to loosen dirt in the cooking compartment with steam.
	 Drying program		You can dry the cooking compartment quickly, e.g. after cleaning, using the drying program.
	 Descaling program		The descaling program can be used to remove limescale from the appliance.
* Heating function used to determine the energy efficiency class in accordance with EN 60350-1.			

## Accessories

Use only the accessories supplied with the product or available from the after-sales service. They are specially designed for your appliance. Ensure that you always insert the accessories into the cooking compartment the right way round.

Your appliance is equipped with the following accessories:



### Wire rack

for cookware, cake tins and casseroles and for roasts

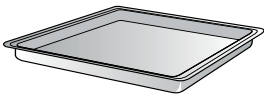

### Cooking container made of stainless steel, unperforated, 40 mm deep

For catching dripping liquid when steaming and for cooking rice, pulses and cereals

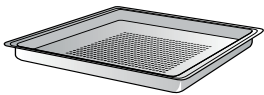

### Stainless steel cooking container, perforated, 40 mm deep

For steaming vegetables or fish, juicing berries and defrosting

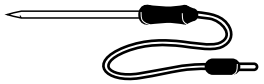

**Core temperature probe**  
for precise preparation of meat, fish, poultry and bread

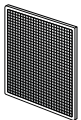

### Grease filter

protects the fan of the back panel of the cooking compartment from becoming dirty (e.g. from spattering)

## Special accessories

You can order the following special accessories from your specialist dealer:

BA 010 301	Triple telescopic pull-out rack
BA 020 360	Container made of stainless steel, unperforated, 40 mm deep, 5 l
BA 020 370	Stainless steel container, perforated, 40 mm deep, 5 l
BA 020 380	Container, non-stick, unperforated, 40 mm deep, 5 l
BA 020 390	Container, non-stick, perforated, 40 mm deep, 5 l
BA 030 300	Wire rack, with feet
17002490	Set with four descaling tablets
GN 010 330	GN adapter (For use with GN cooking inserts and roasters)
GN 114 130	Stainless steel cooking container GN 1/3, perforated, 40 mm deep, 1.5 l
GN 114 230	Stainless steel cooking container GN 2/3, unperforated, 40 mm deep, 3 l
GN 124 130	Stainless steel cooking container GN 1/3, perforated, 40 mm deep, 1.5 l
GN 124 230	Stainless steel cooking container GN 2/3, perforated, 40 mm deep, 3 l

Only use the accessories as specified. The manufacturer accepts no liability if these accessories are used incorrectly.

The non-stick cooking containers must not be heated to more than 230 °C. Use the non-stick cooking container only in the combi-steam oven.

---

## Before using for the first time

---

In this section, you can find out what you must do before using your appliance to prepare food for the first time. First read the section entitled → "Important safety information" on page 5.

The appliance must be fully installed and connected to the mains.

After connecting the appliance to the power supply, the "Initial settings" menu will be displayed. Now you can now configure your new appliance for initial set-up.

### Notes

- The "Initial settings" menu will appear only after the appliance has been connected to a power supply and switched on for the first time, or if the appliance has not been connected to a power supply for a number of days. Once the appliance has been connected to a power supply, the GAGGENAU logo will appear first for approximately 30 seconds. The "Initial settings" menu will then appear automatically.
- You can change the settings at any time in the basic settings.

## Setting the language

The preset language appears in the display.

- 1 Turn the rotary selector to select the required display language.
- 2 Confirm with ✓.

## Setting the time format

The two possible formats 24h and AM/PM appear in the display. The default is the 24h format.

- 1 Use the rotary selector to select the desired format.
- 2 Confirm with ✓.

## Setting the clock

The time is shown in the display.

- 1 Set the desired time using the rotary selector.
- 2 Confirm with ✓.

## Setting the date format

The three possible formats D.M.Y, D/M/Y and M/D/Y appear in the display. The default is the D.M.Y format.

- 1 Use the rotary selector to select the desired format.
- 2 Confirm with ✓.

## Setting the date

The preset date appears in the display. The day setting is already active.

- 1 Set the day using the rotary selector.
- 2 Touch the > symbol to switch to the month setting.
- 3 Set the month using the rotary selector.
- 4 Touch the > symbol to switch to the year setting.
- 5 Set the year using the rotary selector.
- 6 Confirm with ✓.

## Setting the temperature unit

The two possible units °C and °F will appear on the display. The default unit is °C.

- 1 Use the rotary selector to select the unit you require.
- 2 Confirm with ✓.

## Setting the water hardness

"Water hardness" appears in the display.

- 1 Check the mains water with the included carbonate hardness test: fill the small measurement tube with mains water up to the 5 ml mark.
- 2 Add drops of indicator solution until the color changes from purple to yellow.  
**Important:** count the drops and carefully swing the measurement tube after every drop until the liquids have mixed thoroughly. The number of drops corresponds to the water hardness.
- 3 Use the rotary selector to set the measured water hardness. The value 12 is set by default.
- 4 Confirm with ✓.

## Ending initial set-up

"Initial set-up complete" will appear on the display.

Confirm with ✓.

The appliance will switch to standby mode and the standby display will appear. The appliance is now ready to use.

## Grease filter

Hook the enclosed grease filter onto the two bolts on the back wall of the cooking compartment. Ensure that you do not scratch the back wall when doing so.

Leave the grease filter in the cooking compartment for all applications. Clean the grease filter with hot soapy water or in the dishwasher every time heavy dirt deposits have been left behind after cooking.

## Cleaning the door panel

The door seal has been greased in the factory to make it leaktight. There may be traces of grease left on the door panel.

Clean the door panel with glass cleaner and a window cloth or microfibre cloth before using the appliance for the first time. Do not use glass scrapers.

## Cleaning accessories

Before using the accessories for the first time, clean them thoroughly using hot detergent solution and a soft cloth.

## Heating up the appliance

Make sure that there is no leftover packaging in the cooking compartment.

To eliminate the new-appliance smell, heat up the empty appliance with the door closed. One hour with hot air + 60% humidity at 200 °C is ideal for this.

## Activating the appliance

### Standby

The appliance switches to standby mode if no function is set or the childproof lock is activated.

The brightness of the control panel is dimmed in standby mode.



### Notes

- Different displays can be shown in standby mode. The default setting is the GAGGENAU logo and the time. You can adjust the display using the "Standby screen" setting in the basic settings. → "Basic settings" on page 32
- The brightness of the display depends on the vertical viewing angle. You can adjust the display using the "Brightness" setting in the basic settings.

## Activating the appliance

To exit standby mode, you can either

- Turn the function selector,
- Touch a control panel,
- Open or close the door.

You can now set the desired function. You can read about how to set functions in the respective chapters.

### Notes

- When "Standby screen = off" is selected in the basic settings, you must turn the function selector to exit standby mode.
- The appliance returns to the standby screen if you have not made any settings for a long time after activation.
- When the door is open, the interior lighting switches off after a short time.

## Operating the appliance

### Filling the water tank

To cook with steam, open the appliance door and fill the water tank on the right with water before starting the appliance. To cook without steam, leave the empty water tank in the tank slot in the appliance.

Make sure that you have set the correct water hardness.  
→ "Setting the water hardness" on page 14

The appliance, tank and tank lid bear the symbols for fresh water and used water. Look for the symbols for fresh water and used water – these tell you which tank lid to fit on which tank and where to slide each tank into the appliance. If you fit the wrong tank lid, it will not close properly. If you slide either of the tanks into the wrong opening, you will not be able to push it in all the way.

#### **⚠ Warning – Risk of injury and risk of fire!**

Only fill the water tank with water or with the descaling solution that is recommended by us. Do not pour any flammable liquids (e.g. alcoholic drinks) into the water tank. Due to hot surfaces, vapours from flammable liquids may catch fire in the cooking compartment (explosion). The appliance door may spring open. Hot steam and jets of flame may escape.

#### **⚠ Warning – Risk of burns/scalding!**

The front of the cooking compartment becomes very hot when in use. When removing the water tank, only touch its handle.

#### **Caution!**

##### **Use of unsuitable liquids may damage the appliance**

- Only use fresh tap water, softened water or uncarbonated mineral water.
- If your tap water is very hard, we recommend that you use softened water.
- Do not use distilled water, highly chlorinated tap water (> 40 mg/l) or other liquids.

You can obtain information about your tap water from your water supplier. The water hardness can be checked with the test set enclosed.

If you select a type of heating that requires steam, fill the water tank before each operation:

- 1 Open the appliance door.
- 2 Pull the fresh water tank out of the appliance until the fill level indicator is visible (fig. A).

- 3 Fill the fresh water tank with cold water up to the "Max." mark (fig. B).

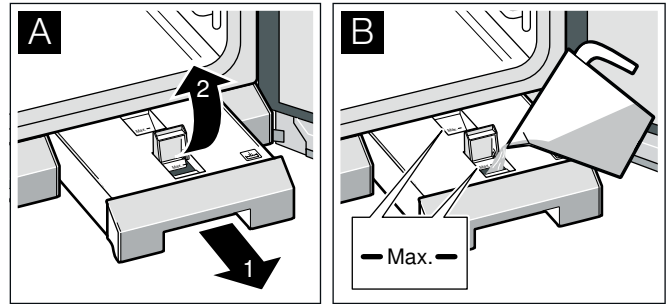

- 4 Slide the fresh water tank all the way back in.

### Cooking compartment

The cooking compartment has three rack levels. The rack levels are counted from the bottom up.

**Note:** When steaming, defrosting, dough proving and reheating, you can use up to three rack levels at a time. Only one level can be used for baking; level 2 is designated for this (or level 1 for deep baking tins). For very small baked goods, you can also use two levels, e.g. level 1 and level 3.

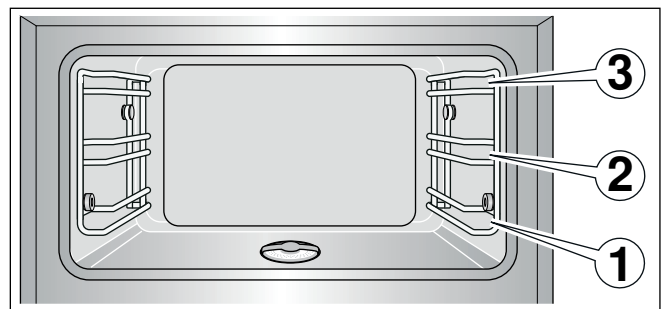

#### **Caution!**

- Do not place anything directly on the cooking compartment floor. Do not cover it with aluminium foil. A build-up of heat may damage the appliance. The cooking compartment floor must always be kept clear. Always place cookware in the perforated cooking container or on the wire rack.
- Do not slide any accessories between the wire rack rails, or they may tilt.

Always fully open the appliance door to the stop. In this position, the open door will not swing back by itself.



## Inserting accessories

The wire rack and the perforated cooking container are fitted with a locking function. The locking function prevents the accessories from tilting when they are pulled out. The accessories must be correctly inserted into the cooking compartment for the tilt protection to work properly. To pull out the accessories, lift them slightly.

When inserting the wire rack, make sure that

- the lug (a) is facing downwards
- the safety bar on the wire rack is at the back and facing upwards.

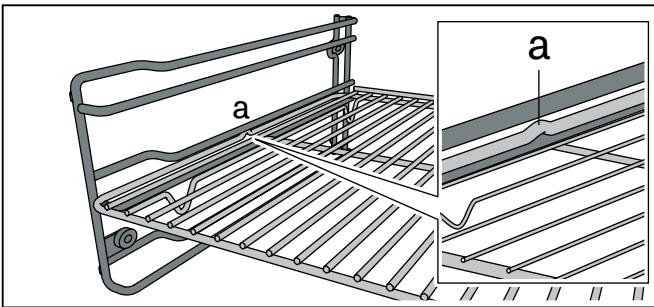

When inserting the cooking container, ensure that the lug (a) is facing upwards.

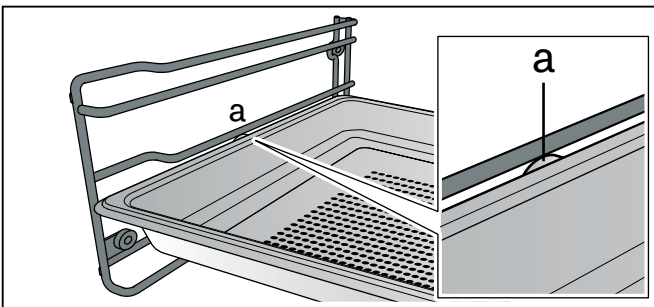

## Switching on

- 1 Use the function selector to set the required type of heating. The selected type of heating and recommended temperature appear on the display.
- 2 If you wish to change the temperature: Turn the rotary selector to set the desired temperature.

The heat-up symbol  $\gg$  appears on the display. The bar shows the current heat-up status. When the set temperature has been reached, an audible signal sounds and the heat-up symbol  $\gg$  goes out.

### Refill with water:

If the water tank is empty, a message appears on the display. Fill the water tank to the "max" mark and slide it back in.

**Note:** During operation the water tank remains locked in the appliance. The water tank can only be taken out for refilling if the message appears on the display.

## Switching off

Turn the function selector to 0.

Depending on the operating mode, you may hear an automatic rinse cycle running.

## Steam injection

With steam injection, steam is injected into the cooking compartment as required. This enables you to bake food such as bread and bread rolls with sufficient moisture. It also gives yeast-risen baked goods a smooth, shiny crust.

Steam injection only works with the following heating functions:

- Hot air + 30% humidity
- Hot air + 0% humidity
- Full surface grill + air recirculation

Before heating up the appliance, make sure that there is water in the fresh water tank. If the fresh water tank is empty, the  $\downarrow$  symbol will not be shown on the display.

To start steam injection, touch the  $\downarrow$  symbol. After a short while, steam is injected into the cooking compartment.

Steam is injected for approx. 5 minutes.

### To cancel steam injection:

Press the  $\downarrow$  symbol.

## After every use

### Emptying the water tank

- 1 Open the appliance door carefully, as hot steam will escape when you do so.
- 2 Remove and empty both water tanks.

### Caution!

Do not dry the water tank in the hot cooking compartment. This will damage the water tank.

### Drying the cooking compartment

- 1 Remove food remnants from the cooking compartment surfaces as soon as the appliance has cooled down. Burnt-on remnants will be much harder to remove later.
- 2 Once the cooking compartment has cooled down, wipe it out and dry it thoroughly with a soft cloth.
- 3 Wipe kitchen units and handles dry where condensation has formed.
- 4 If required, you can dry the cooking compartment quickly using the drying program. → "Drying programme" on page 35

## Safety shut-off

For your protection, the appliance is equipped with an automatic safety shut-off. Any heating process is switched off after 12 hours if the oven is not operated in this time. A message appears in the display.

Exception:

The long-term timer has been programmed.

Set the function selector to **0**, then the appliance can be operated again as usual.

## Time-setting options

You use the timer menu to make the following settings:

⌚ Short-term timer

⌚ Stopwatch

🕒 Cooking time (not in standby mode)

🕒 Cooking time end (not in standby mode)

## Calling up the timer menu

You can call up the timer menu from any mode. Only from the basic settings, function selector is set to **S**, the timer menu is not available.

Touch the 🕒 symbol.

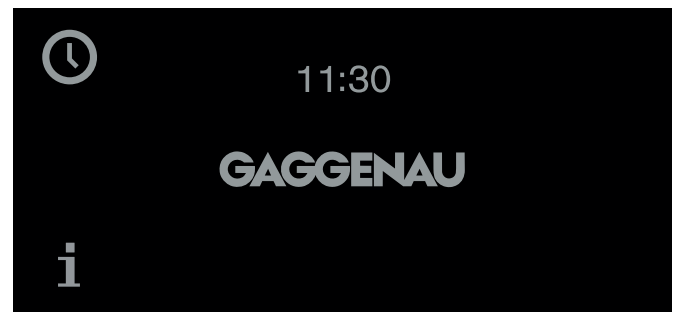

The timer menu is displayed.

## Timer

The timer runs independently of the other appliance functions. You can enter a maximum of 90 minutes.

### Setting the timer

- 1 Call up timer menu.  
The "Timer" ⌚ function is displayed.
- 2 Turn the rotary selector to set the required cooking time.

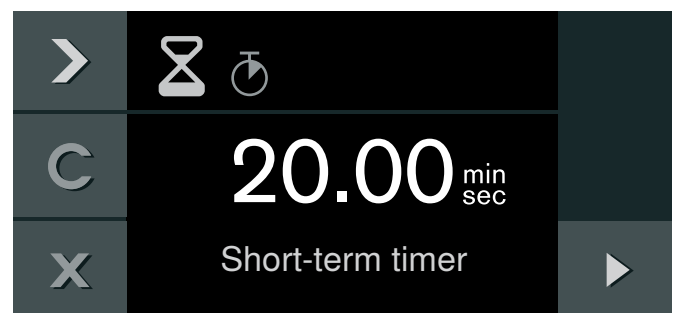

- 3 Start with ▶.

The timer menu closes and the time begins to count down. The ⌚ symbol and the countdown appear in the display.

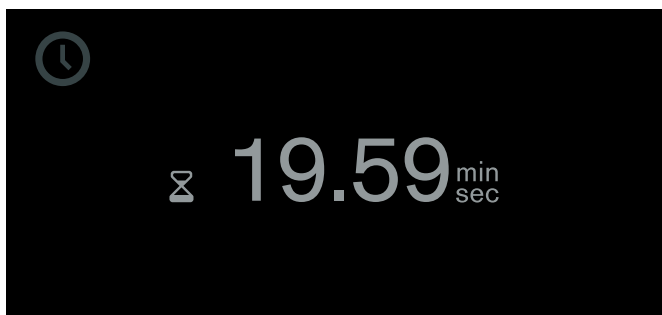

A signal sounds once the time has elapsed. Touch the ✓ symbol to silence.

You can exit the timer menu at any time by pressing the ✕ symbol. This erases the settings.

#### To stop the timer:

Call up timer menu. Touch > to select the "Timer" ⌚ function and touch the || symbol. To allow the timer to continue counting down, touch the ▶ symbol.

#### Switching off the timer early:

Call up timer menu. Touch > to select the "Timer" ⌚ function and touch the C symbol.

## Stopwatch

The stopwatch runs independently of the other appliance functions.

The stopwatch counts from 0 seconds up to 90 minutes.

It also has a pause function, which enables you to temporarily stop the clock.

#### Starting the stopwatch

- 1 Call up the timer menu.
- 2 Touch > to select the ⌚ "Stopwatch" function.

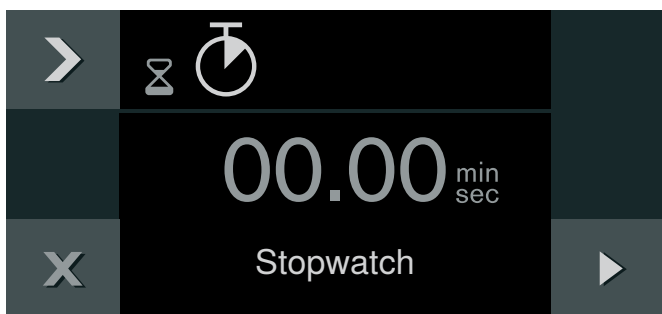

- 3 Touch ▶ to start.

The timer menu is closed and the timing begins. The ⌚ symbol and the elapsed time are shown in the display.

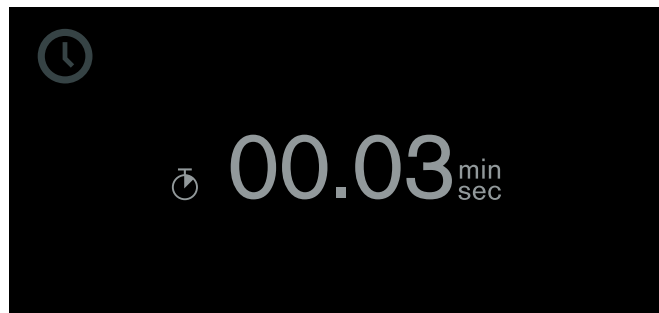

#### Pausing and restarting the stopwatch

- 1 Call up the timer menu.
- 2 Touch > to select the ⌚ "Stopwatch" function.
- 3 Touch the || symbol.

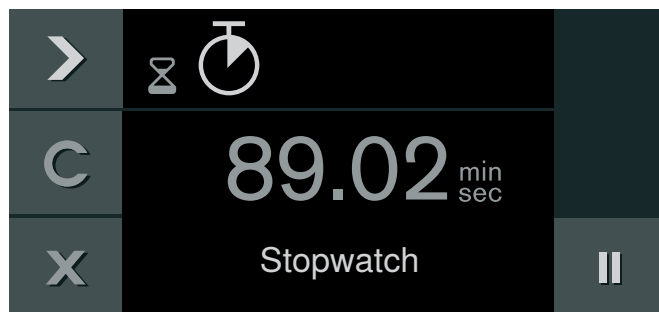

The time stops. The symbol changes to ▶ Start.

- 4 Touch ▶ to start.

The time continues to run. When 90 minutes is reached, the display pulsates and signal sounds. The signal stops when you touch the ✓ symbol. The ⌚ symbol on the display goes out. The process has finished.

#### To switch off the stopwatch:

Call up the timer menu. Touch > to select the ⌚ "Stopwatch" function and touch the C symbol.

## Cooking time

If you set a cooking time for your meal, the appliance switches off heating automatically after the selected time.

You can set a cooking time from 1 minute to 23 hours 59 minutes.

#### Setting the cooking time

You have set the type of heating and temperature and placed your food in the cooking compartment.

- 1 Touch the ⌚ symbol.
- 2 Use > to select the ⌚ "Cooking time" function.

- 3 Set the required cooking time using the rotary selector.



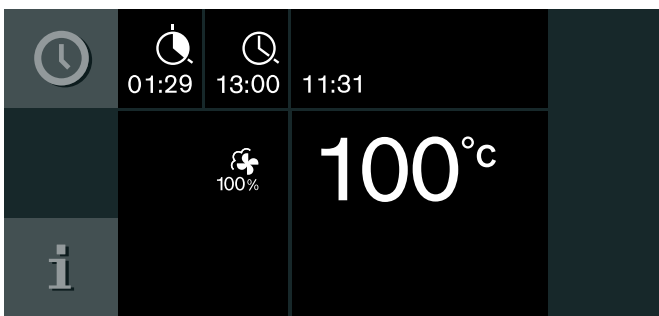

- 4 Press ▶ to start.

The appliance starts. The Timer menu closes. The display shows the temperature, operating mode, remaining cooking time and cooking time end.

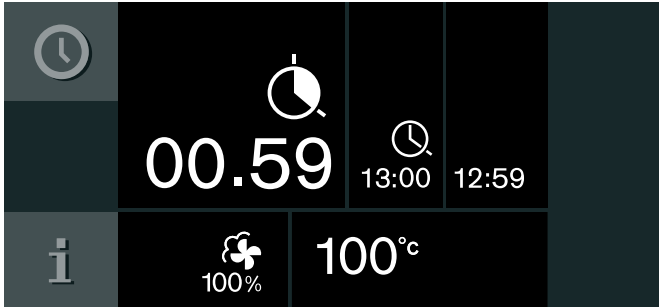

One minute before the end of the cooking time, the elapsed cooking time is shown enlarged on the display.



Once the cooking time has elapsed, the appliance switches off. The  symbol flashes and an audible signal sounds. The signal stops early if you touch the symbol, open the appliance door, or set the function selector to 0. ✓

#### Changing the cooking time:

Call up the Timer menu. Use ▶ to select the  "Cooking time" function. Use the rotary selector to change the cooking time. Press ▶ to start.

#### To cancel the cooking time:

Call up the Timer menu. Use ▶ to select the  "Cooking time" function. Cancel the cooking time with C. Press X to return to normal operation.

#### To cancel the entire procedure:

Set the function selector to 0.

**Note:** You can also change the type of heating and temperature while the cooking time elapses.

## End of cooking time

You can delay the cooking time end to a later time.



Example: it is 14:00. The dish requires a cooking time of 40 minutes. You want it to be ready at 15:30.

Enter the cooking time and delay the cooking time end until 15:30. The electronics system calculates the start time. The appliance starts automatically at 14:50 and switches off at 15:30.

Bear in mind that food which spoils easily should not be left in the cooking compartment for too long.

#### Delaying the cooking time end

You have set the type of heating, temperature and cooking time.

- 1 Touch the  symbol.
- 2 Use ▶ to select the  "Cooking time end" function.

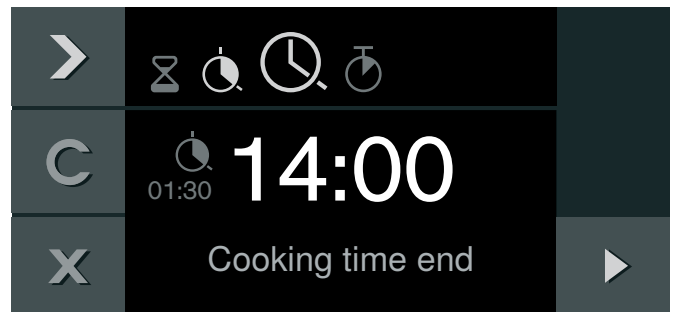



- 3 Set the required cooking time end using the rotary selector.

- 4 Press ▶ to start.



The appliance switches to standby. The display shows the operating mode, temperature, cooking time and cooking time end. The appliance starts at the calculated time and automatically switches off once the cooking time has elapsed.

**Note:** If the  symbol flashes, you have not set a cooking time. Always begin by setting a cooking time.

Once the cooking time has elapsed, the appliance switches off. The  symbol flashes and an audible signal sounds. The signal stops early if you touch the  symbol, open the appliance door or set the function selector to 0. ✓

#### Changing the cooking time end:

Call up the Timer menu. Use ▶ to select the  "Cooking time end" function. Set the required cooking time end using the rotary selector. Press ▶ to start.

**To cancel the entire procedure:**

Set the function selector to **0**.

Once the set time has elapsed, the appliance stops heating. Turn the function selector to **0**.

**Switching off:**

To end the process, turn the function selector to **0**.

---

## Long-term timer

---

With the appliance in "Hot air + 0% humidity" mode, this function keeps the temperature between 50 and 230 °C.

You can keep food warm for up to 74 hours without having to switch the appliance on and off.

Bear in mind that food which spoils easily should not be left in the oven for too long.

**Note:** To use the long-term timer, you will need to set it to "available" in the basic settings.

## Setting the long-term timer

- 1 Set the function selector to ☀.
- 2 Touch the ⏸ symbol.  
The default value 24 hrs at 85 °C appears in the display. Press ▶ to start  
-or-  
Change the cooking time, the cooking time end, the switch-off date and the temperature.

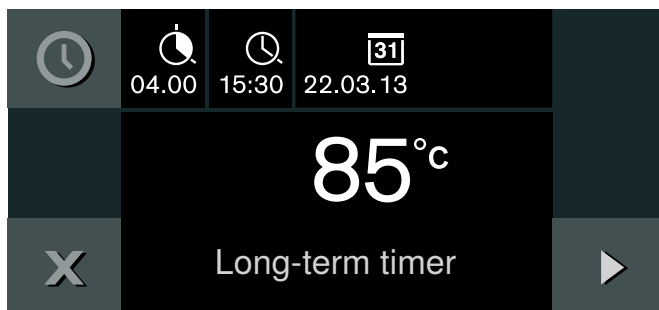

- 3 Changing the cooking time ⌚:  
Touch the ⌚ symbol. Set the required cooking time using the rotary selector.
- 4 Changing the cooking time end ⌚:  
Touch the ⌚ symbol. Set the required cooking time end using the rotary selector.
- 5 Changing the switch-off date 📅:  
Touch the ⌚ symbol. Set the required switch-off date with the rotary selector. Confirm with ✓.
- 6 Changing the temperature:  
Set the required temperature with the rotary selector.
- 7 Press ▶ to start.

The appliance starts. ⏸ and the temperature appear in the display.

The oven and display lighting are switched off. The control panel is locked; no key tone sounds when you touch the touch keys.

## Childproof lock

The appliance has a childproof lock to prevent children operating it accidentally.

### Notes

- To use the childproof lock, you will need to set it to "available" in the basic settings.
- If there is a power cut after the childproof lock has been activated, the childproof lock may be deactivated when the power comes back on.

## Activate the child lock

### Prerequisite:

The function selector is set to 0.

Touch and hold the  symbol for at least 6 seconds.

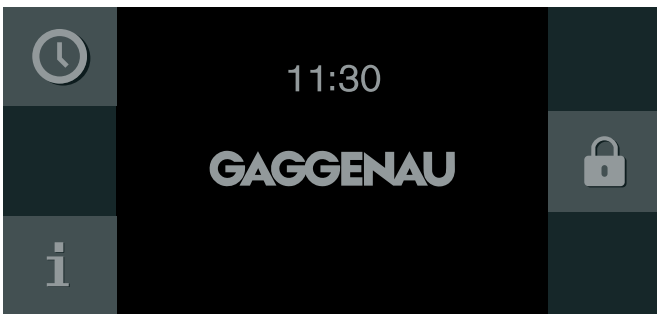

The child lock is activated. The standby screen appears. The  symbol is shown at the top of the display.

## Deactivating the child lock

### Prerequisite:

The function selector is set to 0.

Touch and hold the  symbol for at least 6 seconds.

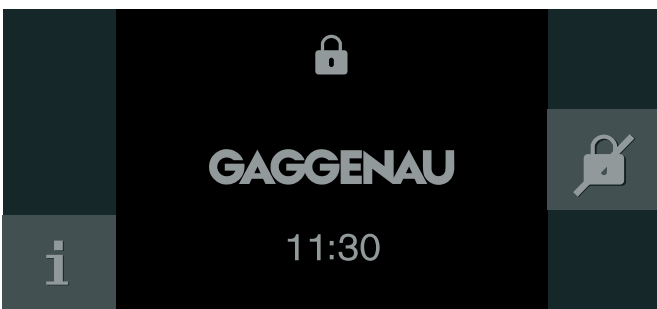

The child lock is deactivated. You can set the appliance as usual.

## Automatic programmes

You can prepare a wide range of food using the automatic programmes. The appliance will choose the optimal setting for you.

To achieve good results, the cooking compartment must not be too hot for the type of food you have selected. If it is, a message will appear on the display. Allow the appliance to cool and then try again.

## Information on the settings

- The cooking result depends on the quality of the food and the size and type of cookware. For an optimal cooking result, only use food that is in good condition and meat that is chilled to refrigerator temperature. For frozen food, only use food straight out of the freezer.
- The automatic programme suggests a temperature, type of heating and cooking time.
- For some dishes, you will be required to enter the weight. It is not possible to set weights outside the preprogrammed weight range.
- For some dishes, you will be asked to enter desired level of browning, the thickness of the food and/or the cooking level of the meat or vegetables.
- For some dishes, the cooking compartment is preheated empty. Place the food in the cooking compartment once the preheating is complete and a message appears in the display.
- Your preferred settings will be shown next time as a suggestion.

### Core temperature probe

For some recipes, you will need the core temperature probe. Use the core temperature probe for these recipes. → "Core temperature probe" on page 26

## Selecting a dish

The following categories are available. One or more dishes are listed beside each category.

**Note:** The last selected category is displayed in the first position.







### Categories:

- Meat and poultry
- Fish
- Vegetables
- Side and oven dishes
- Dessert
- Bread and pastries
- Raising dough
- Regenerating
- Defrosting

## Applying settings for a dish

You are guided through the entire setting process. Follow the instructions in the display.

Use the rotary selector to scroll through the individual levels.

- 1 Set the function selector to .
- 2 Touch the  symbol. Press  to confirm.
- 3 Use the rotary selector to select the category and press  to confirm.
- 4 Use the rotary selector to select the required dish and press  to confirm.  
The possible settings appear in the display. For many dishes, you can change the settings to suit your needs.  
For some dishes, you must set the weight.  
**Tip:** By pressing the  symbol, you can receive information about accessories and preparation methods.
- 5 Press  to confirm the required settings. Follow the directions in the display.



Once the cooking time has elapsed, an audible signal sounds. The appliance stops heating.

Opening the appliance door affects the cooking result. Open the appliance door only briefly. The automatic programme is interrupted and continues to run after closing the appliance door.

## Adding extra cooking time

After the cooking time has ended, you can leave some dishes to continue cooking if you are not satisfied with the cooking result.

A query appears in the display asking if you want to continue cooking.

- 1 Press  to confirm.
- 2 Select a single or double cooking time, depending on requirements.
- 3 Press  to start.
- 4 If the "Continue cooking" function has ended, turn the function selector to 0 .





## Changing and cancelling

After starting the appliance, the settings can no longer be changed.

If you want to cancel the operation, turn the function selector to 0 .

## Calling up the last automatic programmes used

The last five dishes with the selected settings are saved. You have the option of saving these dishes with the selected settings as individual recipes. You can no longer retroactively change the settings of individual recipes if you have not saved it using the "Last automatic programmes" function. → *"Individual recipes" on page 24*





- 1 Set the function selector to .  is displayed.
- 2 Touch the  symbol.
- 3 Use the rotary selector to select "Last automatic programmes" and press  to confirm.
- 4 Use the rotary selector to select the required dish and press  to confirm.
- 5 Enter a name for the dish and save. → *"Entering names" on page 25*

## Individual recipes

It is possible to save up to 50 individual recipes. You can record a recipe. These recipes can be given a name so that they can be called up quickly and conveniently when required.

### Recording a recipe

It is possible to set up to 5 phases consecutively while recording at the same time.

- 1 Set the function selector to .
- 2 Touch the  symbol.
- 3 Use the rotary selector to select "Individual recipes" and press  to confirm.
- 4 Use the rotary selector to select a free memory location.
- 5 Touch the  symbol.

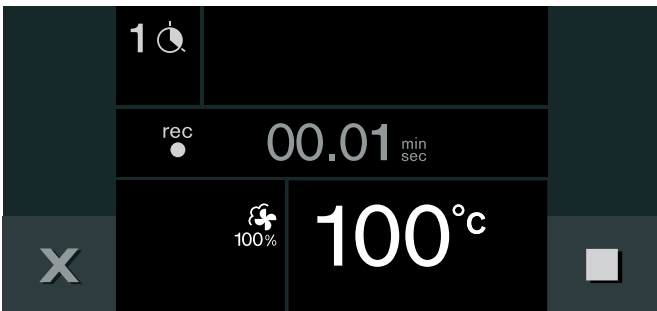





- 6 Use the rotary selector to set the required temperature.
- 7 The cooking time will be recorded.
- 8 To record another phase:  
Turn the function selector to the required type of heating. Use the rotary selector to set the required temperature. This will start a new phase.
- 9 Once you have obtained the cooking result you want for the dish, touch the  symbol to finish the recipe.
- 10 Enter a name for the recipe in "ABC". → "Entering names" on page 25

#### Notes





- The appliance will not start recording a phase until it has reached the set temperature.
- Each phase must last at least 1 minute.
- During the first minute of a phase, you can change the type of heating or the temperature.

### Programming a recipe

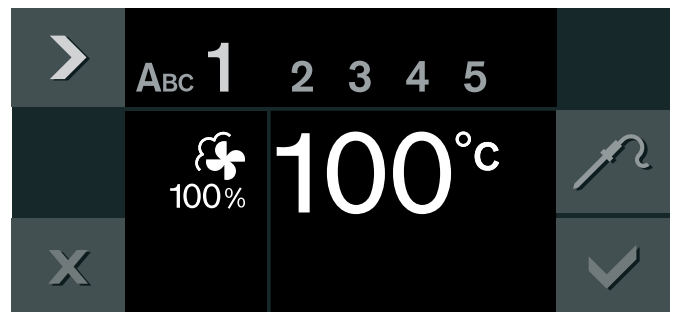

You can programme and save up to 5 preparation phases.

- 1 Set the function selector to .
- 2 Touch the  symbol.
- 3 Use the rotary selector to select "Individual recipes" and press  to confirm.
- 4 Use the rotary selector to select a free memory location.
- 5 Touch the  symbol.
- 6 Enter a name for the recipe in "ABC". → "Entering names" on page 25
- 7 Use the  symbol to select the first phase. The initial type of heating and temperature are displayed. You can change the type of heating and the temperature using the rotary selectors.



- 8 Use the  symbol to select the time setting.
- 9 Set the required cooking time using the rotary selector.
- 10 Use the  symbol to select the next phase.  
- or -  
If preparation is complete, finish making entries.
- 11 Save with .  
- or -  
Cancel with  and exit the menu.

#### To set the core temperature for a phase:

Use the  symbol to select the next phase. Set the heating function and temperature. Touch the  symbol. Use the rotary selector to set the desired core temperature and press  to confirm.

**Note:** Cooking time cannot be set for phases with a programmed core temperature.



## Entering names

- 1 Enter the name of the recipe in "ABC".

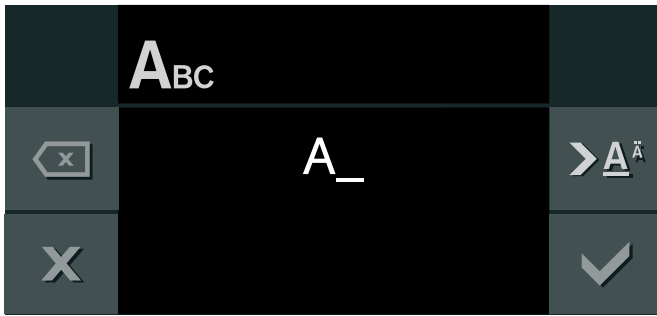

Rotary selector	Select letters A new word always begins with a capital letter.
>A <sup>^</sup>	Press briefly: moves the cursor right Press and hold: shifts to umlauts and special characters Press twice: accepts the change
>Ä	Press briefly: moves the cursor right Press and hold: shift to normal characters Press twice: accepts the change
<X	Deletes letters

- 2 Save with ✓.  
- or -  
Cancel with X and exit the menu.

**Note:** For entering a name, Latin characters, certain special characters and numbers are available.

## Starting recipes

- 1 Set the function selector to ⚙️.
- 2 Touch the 🍲 symbol.
- 3 Use the rotary selector to select "Individual recipes" and press ✓ to confirm.
- 4 Use the rotary selector to select the desired recipe.
- 5 Press ▶ to start.  
The operation starts. The cooking time starts counting down.  
The settings for each phase are shown in the display.

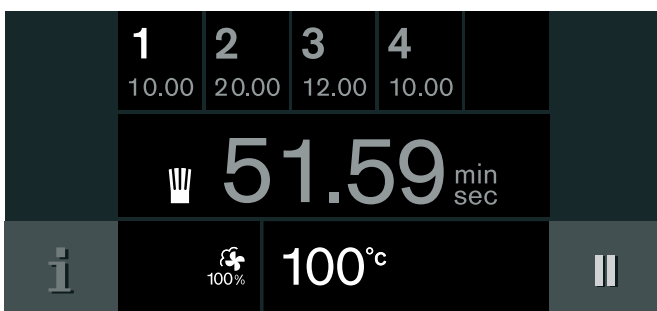

## Notes

- The cooking time does not start counting down until the appliance has reached the set temperature.
- You can use the rotary selector to change the temperature while the recipe is in progress. This does not change the saved recipe.
- Insert the core temperature probe, if the recipe contains a saved core temperature.

## Change recipe

You can change the settings of a recorded or programmed recipe.

- 1 Set the function selector to ⚙️.
- 2 Touch the 🍲 symbol.
- 3 Use the rotary selector to select "Individual recipes" and press ✓ to confirm.
- 4 Use the rotary selector to select the desired recipe.
- 5 Touch the ↵ symbol.
- 6 Use the ▶ symbol to select the desired phase.  
The programmed type of heating, temperature and cooking time are displayed. You can use the rotary selector or function selector to change the settings.
- 7 Save with ✓.  
- or -  
Cancel with X and exit the menu.

## Deleting recipes

- 1 Set the function selector to ⚙️.
- 2 Touch the 🍲 symbol.
- 3 Use the rotary selector to select "Individual recipes" and press ✓ to confirm.
- 4 Use the rotary selector to select the desired recipe.
- 5 Delete the recipe with C.
- 6 Press ✓ to confirm.

## Core temperature probe

The core temperature probe makes it possible to cook with exact precision. It measures the temperature inside the food. When the required core temperature has been reached, the probe switches off automatically, ensuring that all food is cooked perfectly.

The core temperature probe may be damaged at temperatures above 250 °C. Therefore, only use it in your appliance at a maximum temperature of 230 °C.

### **⚠ Warning – Risk of electric shock!**

The insulation of an incompatible meat probe may be damaged. Only use the meat probe which is recommended for this appliance.

### **⚠ Warning – Risk of burns!**

The cooking interior and the core temperature probe become very hot. Use oven mitts to plug and unplug the core temperature probe.

Only use the core temperature probe supplied. You can purchase it as a spare part from the after-sales service or from the online shop.

When using the core temperature probe, never place the food on the top shelf position in the oven.

After use, always remove the core temperature probe from the cooking compartment. Never store it inside the cooking compartment.

After each use, clean the core temperature probe with a damp cloth. Do not clean in the dishwasher.

## Inserting the core temperature probe into the food

Insert the core temperature probe into the food before you place the food in the cooking compartment.

The core temperature probe has three measuring points. Insert the core temperature probe as far as possible. It must not be inserted in the fat or be touching the cookware or bones.

**Meat:** Insert the core temperature probe at the thickest point on the side as far as it will go into the meat. If there is more than one piece of meat, insert the core temperature probe into the middle of the thickest piece.

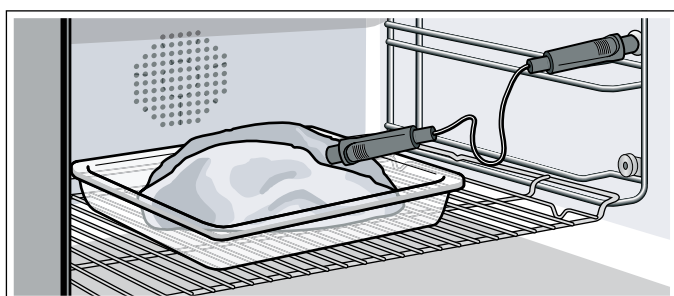

**Poultry:** Insert the core temperature probe as far as it will go into the thickest point in the breast. Depending on its structure, insert the core temperature probe into the poultry crossways or lengthways. With poultry, make sure that the tip of the core temperature probe does not protrude into the cavity in the middle of the bird.

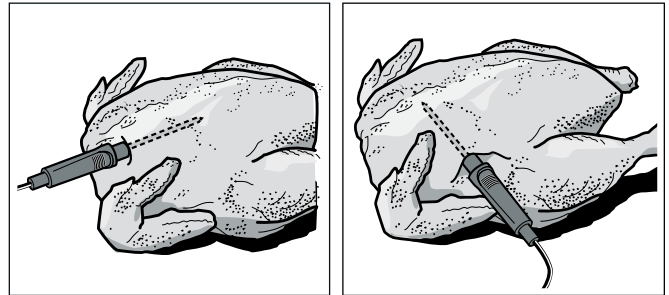

**Fish:** Insert the core temperature probe behind the head as far as it will go towards the spine. Place the whole fish onto the wire rack and prop it up in the swimming position using half a potato.

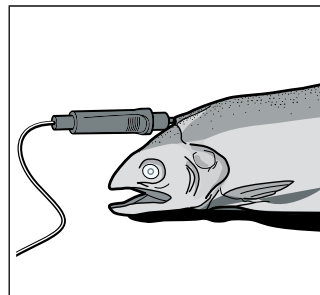

**Turning the food:** If you want to turn the food, do not remove the core temperature probe. Once you have turned the food, check that the core temperature probe is correctly positioned in the food.

If you remove the core temperature probe during operation of the appliance, all settings are reset and you have to apply them again.

## Setting the core temperature

### Caution!



#### Damage to the core temperature probe:

The core temperature probe may be damaged if the distance between the grill heating element and the core temperature probe is too small. Make sure that the distance between the grill heating element and the core temperature probe or the cable of the core temperature probe is a few centimetres. The meat may expand during the cooking process.

### Caution!

#### Damage to the core temperature probe:

Do not trap the cable of the core temperature probe in the appliance door.

- 1 Slide the food into the cooking compartment with the core temperature probe inserted. Plug the core temperature probe into the socket in the cooking compartment and close the appliance door.
- 2 Turn the function selector to the required type of heating.
- 3 Use the rotary selector to set the cooking compartment temperature.
- 4 Touch the  symbol. Using the rotary selector, set the desired core temperature for the food and press  to confirm.  
The set core temperature must be higher than the current core temperature.
- 5 The appliance heats up using the type of heating that has been set.  
The current core temperature is shown in the display, and beneath it, the set core temperature. You can change the set core temperature at any time.

Once the food reaches the core temperature that has been set, an audible signal will sound. Cooking ends automatically. Confirm with  and turn the function selector to **0**.

### Estimated cooking time

After preheating, if the appliance has a temperature setting above 100 °C, when the core temperature probe is inserted, the display shows an estimated cooking time approx. 5–20 minutes into the cooking time.

The estimated cooking time is continually updated. The longer the cooking process lasts, the more precise the estimated cooking time becomes. Do not open the appliance door; this distorts the estimated cooking time.

The estimated cooking time is displayed in normal operation and in the automatic programme.



The current core temperature is shown in the display when you touch the  symbol.

The estimated cooking time display can be deactivated in the basic settings so that the current core temperature is shown instead.



### Notes

- At the beginning of the cooking time, "<15 °C" is displayed for 3–4 minutes for the current core temperature.
- The measurable range is 15 °C to 99 °C. Outside of the measurable area, "<15 °C" is displayed for the current core temperature.
- If you leave food in the cooking compartment for some time after cooking, the core temperature will continue to rise somewhat due to the residual heat in the cooking compartment.
- If you set programmes with the core temperature probe and the cooking timer at the same time, the appliance switches off whichever programme reaches the entered value first.

### Changing the set core temperature

Touch the  symbol. Use the rotary selector to change the set core temperature for the food and press  to confirm.

### Deleting the set core temperature

Touch the  symbol. Delete the set core temperature with . The appliance continues heating in normal cooking operation.

## Suggested values for the core temperature

Only use fresh food that has not been frozen. The figures in the table are given as a guide. They will depend on the quality and composition of the food.

For hygiene reasons, critical foodstuffs such as fish and game should reach a core temperature of 62–70 °C; for poultry and minced meat this should be as high as 80–85 °C.

Food	Suggested value for the core temperature
<b>Beef</b>	
Sirloin, fillet of beef, entrecôte	
Very rare	45–47 °C
Rare	50–52 °C
Medium rare	58–60 °C
Well done	70–75 °C
Roast beef	80–85 °C
<b>Pork</b>	
Joint of pork	
	72–80 °C
Loin of pork	
Medium rare	65–70 °C
Well done	75 °C
Meat loaf	85 °C
Fillet of pork	65–70 °C
<b>Veal</b>	
Joint of veal, well done	
	75–80 °C
Breast of veal, stuffed	
	75–80 °C
Saddle of veal	
Medium rare	58–60 °C
Well done	65–70 °C
Fillet of veal	
Rare	50–52 °C
Medium rare	58–60 °C
Well done	70–75 °C
<b>Game</b>	
Saddle of venison	
	60–70 °C
Leg of roe venison	
	70–75 °C
Venison loin steaks	
	65–70 °C
Saddle of hare or rabbit	
	65–70 °C
<b>Poultry</b>	
Chicken	
	90 °C
Guinea fowl	
	80–85 °C
Goose, turkey, duck	
	85–90 °C
Duck breast	
Medium rare	55–60 °C
Well done	70–80 °C
Ostrich steak	
	60–65 °C

Food	Suggested value for the core temperature
<b>Lamb</b>	
Leg of lamb	
Medium rare	60–65 °C
Well done	70–80 °C
Saddle of lamb	
Medium rare	55–60 °C
Well done	65–75 °C
<b>Mutton</b>	
Leg of mutton	
Medium rare	70–75 °C
Well done	80–85 °C
Saddle of mutton	
Medium rare	70–75 °C
Well done	80 °C
<b>Fish</b>	
Fillet	
	62–65 °C
Whole	
	65 °C
Terrine	
	62–65 °C
<b>Other</b>	
Bread	
	96 °C
Pâté	
	72–75 °C
Terrine	
	60–70 °C
Foie gras	
	45 °C
Reheating food	
	75 °C

## Home Connect

This appliance can be networked and controlled remotely using a mobile device. The Home Connect app offers extra functions that complement the networked appliance perfectly. If the appliance is not connected to your home network, it can be operated as usual via the display.

The availability of the Home Connect function depends on the availability of Home Connect services in your country. Home Connect services are not available in every country. You can find more information on this at [www.home-connect.com](http://www.home-connect.com).

### Notes

- Ensure that you follow the safety instructions in this instruction manual and that you comply with these even when you are away from home and are operating the appliance via the Home Connect app. You must also follow the instructions in the Home Connect app.
- Operating the appliance directly from the appliance always takes priority. It is not possible to operate the appliance using the Home Connect app during this time.
- Refer to the Home Connect documents supplied for more information.

## Setting up

To configure settings via Home Connect, you will need to have installed the Home Connect app on a mobile device.

Your appliance will also need to be connected to your home network and to the Home Connect app. You can choose between the following connection types:

- Connection via LAN cable: The appliance is connected to the home network automatically following confirmation on the appliance.
- Connection via WLAN: Establish the connection to your home network and then the connection to the Home Connect app.

**Note:** The app will guide you through the entire registration process. In case of doubt, follow the instructions in the app.

### Installing the app

Install the Home Connect app on your mobile device (e.g. tablet PC or smartphone).

- 1 On your mobile device, go to the App Store (Apple devices) or the Google Play Store (Android devices).
- 2 Enter the search term "Home Connect".

- 3 Select the Home Connect app and install it on your mobile device.
- 4 Launch the app and set up Home Connect access. The app will guide you through the registration process.





### Connecting the appliance to your home network (LAN)

The appliance must be connected to your home network using a LAN cable.

The network connection will be established automatically when the appliance is connected to the mains electricity supply for the first time and put into operation.





### Connecting the appliance to your home network (WLAN with WPS)

Requirements:

- Your router must have a WPS button. You will find information about this in the manual for your router.
  - You need to be able to access your router.
- 1 In the basic settings, select  "Home Connect".
  - 2 Touch the  symbol.
  - 3 Turn the rotary selector to "WLAN".
  - 4 Touch the  symbol to confirm. A message about the WPS function will appear.
  - 5 Touch the  symbol to continue.
  - 6 Turn the rotary selector to "Automatic (WPS)".
  - 7 Touch the  symbol to start the connection process.
  - 8 Press the WPS button on the router within the next 2 minutes.

If the display shows "Network connection successful", the connection process is complete. Follow the instructions in the app.

### Connecting the appliance to your home network (WLAN without WPS)



- 1 In the basic settings, select  "Home Connect".
- 2 Touch the  symbol.
- 3 Turn the rotary selector to "WLAN".
- 4 Touch the  symbol to confirm. A message about the WPS function will appear.
- 5 Touch the  symbol to continue.
- 6 Turn the rotary selector to "Manual".
- 7 Touch the  symbol to start the connection process. The appliance will set up its own "Home Connect" WLAN network to which the tablet or smartphone must be connected.
- 8 Follow the instructions in the app.

If the display shows "Network connection successful", the connection process is complete. Follow the instructions in the app.

### Connecting the appliance to the app

Connect your appliance to the app when setting up Home Connect or connect your appliance to an additional Home Connect account. The Home Connect app can be installed on any number of mobile devices, which can then be connected to the appliance.





Requirements:

- The appliance is connected to the home network.
  - The Home Connect app has been installed on the mobile device.
- 1 To connect an additional account, select "Home Connect" in the basic settings.
  - 2 Use the rotary selector to select "Connect to app".
  - 3 Touch the  symbol and start the connection process with .
  - 4 Follow the instructions in the app.

If the display shows "Connection to app successful", the connection process is complete.

## Home Connect settings

Home Connect can be adapted to your specific needs at any time.

	Basic setting	Permitted settings	Explanation
	Connection type	LAN/Wi-Fi	You can switch between connection types (LAN cable and Wi-Fi). Follow the instructions for setting up the relevant connection type. → "Setting up" on page 29
	Connecting	Connect/disconnect	Switch the network connection on or off as required (e.g. for holiday). Network information is retained after the appliance is switched off. After switching on the appliance, you will need to wait for a few seconds while it reconnects to the network. In networked standby mode, the appliance requires max. 2 W.
	Connect to app		Start the connection process between the app and the appliance.
	Software update		As soon as a new software version is available, a message appears in the display. You can install the new software in the Home Connect menu  .

## Remote Start





Remote start must be activated in order to start and operate your appliance via the Home Connect app. If remote start is deactivated, the Home Connect app will only show the operating modes of the appliance and let you configure the settings.

Remote start is automatically deactivated in the following situations:

- The appliance door is opened at least 15 minutes after remote start has been activated.
- The appliance door is opened at least 15 minutes after operation has ended.
- 24 hours after remote start has been activated.

When you start a type of heating using the controls on the appliance, remote start is activated automatically. You can now make changes or start a new programme from your mobile device.



### Activating remote start

- 1 Set the function selector to .
- 2 Touch the  symbol.  
The symbol  appears next to the .

Remote start is activated. You can now start a heating mode via the app on the mobile device and send the desired settings to the appliance.

Touch the  symbol to deactivate remote start.

**Note:** You will find the Home Connect settings in the basic settings for your appliance. Which settings the display shows will depend on whether Home Connect has been set up and whether the appliance is connected to your home network.

	Remote control	Activate/deactivate	Access the appliance's functions via the Home Connect app. When deactivated, only the appliance's operating statuses will be displayed in the app.
	Delete network settings		All network settings can be deleted from the appliance at any time.
	Appliance information		The display shows: <ul style="list-style-type: none"> <li>● MAC address COM module</li> <li>● Serial number of the appliance</li> <li>● Software version</li> </ul> You can view more information – such as the SSID (network name), although this depends on the connection type – by touching the arrow button.

## Remote diagnostics

Customer Service can use Remote Diagnostics to access your appliance if you contact them, have your appliance connected to the Home Connect server and if Remote Diagnostics is available in the country in which you are using the appliance.

**Note:** For further information and details about the availability of Remote Diagnostics in your country, please visit the service/support section of your local website: [www.home-connect.com](http://www.home-connect.com)

## About data protection

When your appliance is connected for the first time to a WLAN network, which is connected to the Internet, your appliance transmits the following categories of data to the Home Connect server (initial registration):

- Unique appliance identification (consisting of appliance codes as well as the MAC address of the installed WiFi communication module).
- Security certificate of the WiFi communication module (to ensure a secure IT connection).
- The current software and hardware version of your domestic appliance.
- Status of any previous resetting to factory settings.

This initial registration prepares the Home Connect functions for use and is only required when you want to use these Home Connect functions for the first time.

**Note:** Ensure that the Home Connect functions can be used only in conjunction with the Home Connect app. Information on data protection can be accessed in the Home Connect app.

## Declaration of Conformity

Gaggenau Hausgeräte GmbH hereby declares that the appliance which features Home Connect is in accordance with the basic requirements and the other relevant provisions of the directive 2014/53/EU.

A detailed RED Declaration of Conformity can be found online at [www.gaggenau.com](http://www.gaggenau.com) on the product page for appliance in the additional documents.



2.4 GHz band: max. 100 mW

5 GHz band: max. 100 mW



BE	BG	CZ	DK	DE	EE	IE	EL
ES	FR	HR	IT	CY	LV	LT	LU
HU	MT	NL	AT	PL	PT	RO	SI
SK	FI	SE	UK	NO	CH	TR	

5 GHz Wi-Fi: for indoor use only













## Basic settings

Your appliance can be individually adjusted in the basic settings.

















- 1 Turn the function selector to **S**.
- 2 Select "Basic settings" using the rotary selector.
- 3 Touch the ✓ symbol.

- 4 Turn the rotary selector to select the required basic setting.
- 5 Touch the ↵ symbol.
- 6 Set the basic setting using the rotary selector.
- 7 Save with ✓ or cancel with ✕ and exit the current basic setting.
- 8 Turn the function selector to **0** to exit the basic settings menu.

The changes are saved.

	Basic setting	Permitted settings	Explanation
	Brightness	Level 1, 2, 3, 4, 5*, 6, 7, 8	Sets the display brightness
	Standby screen	On*/Off - Clock - Clock + GAGGENAU logo* - Date - Date + GAGGENAU logo - Clock + date - Clock + date + GAGGENAU logo	Appearance of the standby screen. Off: No display. Use this setting to reduce the standby consumption of your appliance. On: Several displays can be set, confirm "On" with ✓ and use the rotary selector to select the desired display. The selection is displayed.
	Display	Reduced*/Standard	If the 'Reduced' setting has been selected, only the most important information will be shown on the display after a short time.
	Touch field colour	Grey* / White	Selects the colour of the symbols on the touch fields
	Touch field tone	Tone 1* / Tone 2 / Off	Selects an audible signal for when a touch field is touched
	Touch field tone volume	Level 1, 2, 3, 4, 5*, 6, 7, 8	Sets the volume of the touch field tone
	Preheating signal	On* / Off	The signal tone sounds when the cooking compartment has heated up to the required temperature.
	Signal volume	Level 1, 2, 3, 4, 5*, 6, 7, 8	Sets the volume of the audible signal
	Water hardness	1-18	Use the test kit included to test the water hardness of your mains water. Set the measured water hardness.
	Time format	AM/PM / 24 h*	Display the clock in 24 or 12-hour format
	Time	Current time	Setting the clock
	Clock change	Manual* / Automatic	Automatically changes the clock to daylight-savings time. If automatic: Setting the month, day and week for when the time should be changed over. To be set for both summer and winter time.
	Date format	D.M.Y* D/M/Y M/D/Y	Sets the date format



	Date	Current date	Sets the date. You can switch between year/month/day using the symbol >.
	Temperature unit	°C* / °F	Setting the temperature unit
	Weight unit	kg*/oz.	Set the weight unit
	Language	German* / French [...] / English	Select the language for the text display <b>Note:</b> The system will restart if the language is changed. This process takes a few seconds. The basic settings menu is then closed.
	Factory settings	Restore appliance to factory settings	Confirm the question "Delete all individual settings made and reset to factory settings?" by pressing ✓ or cancel by pressing X. <b>Note:</b> Individual recipes will also be deleted if the appliance is restored to factory settings. After restoring factory settings, the "Initial settings" menu is displayed.
	Demo mode	On / Off*	Only for presentation purposes. The appliance does not heat up in demo mode, all other functions are available.  The "Off" setting must be activated for normal operation. The setting is only possible in the first 3 minutes after connecting the appliance to the mains.
	Long-term timer	Not available*/Available	Available: Long-term timer can be set. → "Long-term timer" on page 21
	Display estimated cooking time with core temperature probe	On*/off	On: Estimated cooking time is shown in the display when the core temperature probe is used.
	Childproof lock	Not available*/Available	Available: The childproof lock can be activated. → "Childproof lock" on page 22
	Home network	<small>LAN / WLAN</small> Connection type  Connection  Connect to app  Software update  Remote control  Delete network settings  Appliance information	Settings for the connection to the home network and the mobile devices.  Different setting options will be displayed depending on the connection status.

\* Factory setting

## Cleaning and maintenance

With thorough care and cleaning your appliance will retain its looks and remain in good order. We will explain here how you should care for and clean your appliance correctly.

### **Warning – Risk of electric shock!**

Do not use any high-pressure cleaners or steam cleaners, which can result in an electric shock.

### **Warning – Risk of burns!**

The appliance becomes very hot. Never touch the interior surfaces of the cooking compartment or the heating elements. Always allow the appliance to cool down. Keep children at a safe distance.

### **Warning – Risk of injury!**

Scratched glass in the appliance door may develop into a crack. Do not use a glass scraper, sharp or abrasive cleaning aids or detergents.

## Cleaning agents

Pay attention to the information in the table to avoid damaging the various surfaces by incorrect cleaning agents.

Do not use

- harsh or abrasive cleaning agents
- metal or glass scrapers to clean the glass on the appliance door
- metal or glass scrapers to clean the door seal
- hard abrasive pads or cleaning sponges

Thoroughly rinse out new sponge cloths before use.

Area	Cleaning products
Door panels	Glass cleaner: Clean with a window cloth or a microfibre cloth. Do not use a glass scraper.
Display	Wipe down using a microfibre cloth or a slightly damp cloth. Do not wipe with a wet cloth.
Stainless steel	Hot soapy water: Clean using a dish cloth and then dry with a soft cloth. Remove splashes and patches of limescale, grease, starch and albumin (e.g. egg white) immediately. Corrosion may form under these patches or splashes. Special stainless-steel cleaning products are available from our after-sales service or from specialist retailers.
Aluminium	Clean with a mild window-cleaning agent. Using a window cloth or a lint-free microfibre cloth, wipe over the surfaces lightly in a horizontal direction.

Area	Cleaning products
Cooking compartment	<p>Hot soapy water: Clean with a dish cloth and dry with a soft cloth.</p> <p>Do not use oven spray or other aggressive oven cleaners or abrasive materials. Scouring pads, rough sponges and pan cleaners are also unsuitable. These items scratch the surface.</p> <p>Always dry the cooking compartment after cleaning. → "Drying programme" on page 35</p> <p><b>Caution!</b> If traces of cleaning product are left on the surface, patches and marks can appear when the cooking compartment is heated up. Wash off all traces of cleaning and care products thoroughly with clean water before drying the cooking compartment.</p> <p><b>Note:</b> When cleaning the cooking compartment, always leave both tanks in the appliance so that no water enters the insertion shaft.</p>
Very dirty cooking compartment	<p>Cleaning gel spray for ovens (order number 00311860 from the after-sales service or our online shop).</p> <p><b>Please note:</b></p> <ul style="list-style-type: none"> <li>● The gel must not come into contact with the seals on the door or with the light.</li> <li>● Leave for no more than 12 hours.</li> <li>● Do not use on hot surfaces.</li> <li>● Rinse off thoroughly with water.</li> <li>● Follow the manufacturer's instructions.</li> </ul> <p><b>Note:</b> When cleaning the cooking compartment, always leave both tanks in the appliance so that no water enters the insertion shaft.</p>
Glass ceramic grilling surface	Clean the glass ceramic grilling surface in the cooking compartment regularly with glass ceramic cleaner (order number 00311499 from the after-sales service or from the online shop).
Glass cover for the cooking compartment light	Hot soapy water: Clean with a dish cloth.
Grease filter	Dishwasher
Door seal	Hot soapy water: Clean with a dish cloth and do not scour. Do not use metal or glass scrapers for cleaning.
Do not remove.	
Water tank	Clean in the dishwasher as necessary. Remove the lid and place the water tank upside down in the dishwasher.

Area	Cleaning products
Core temperature probe	Wipe with a damp cloth. Do not clean in the dishwasher.
Cooking container, wire rack	Dishwasher or hot soapy water. Soak burnt-on remnants and remove with a brush.  Remove light-coloured patches on stainless steel (egg white/albumen residues) with lemon juice.
Wire racks	Dishwasher or hot soapy water.

### Microfibre cloth

The honeycomb microfibre cloth is particularly suitable for cleaning sensitive surfaces such as glass, glass ceramic, stainless steel or aluminium (part number 00460770 from our after-sales service or from our online shop). It removes liquid and greasy deposits in one go.

### Strainer filter

You can clean the strainer filter in the cooking compartment floor as necessary. When cooking fish or meat, we recommend cleaning the appliance after each use.

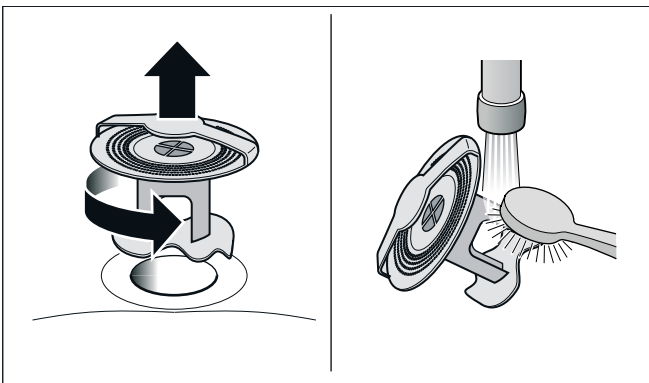



- 1 Turn the strainer filter anticlockwise and remove it.
- 2 Remove any food remnants from the strainer filter.
- 3 Rinse it out under running water. If it is very dirty, wash it in the dishwasher.
- 4 Insert the strainer filter and turn it clockwise as far as it will go.

Never operate the combi-steam oven without the strainer filter in place.

## Cleaning aid

The cleaning aid loosens stubborn dirt in the cooking compartment and makes cleaning easier.

### Starting the cleaning aid

- 1 Set the function selector to **S**.
- 2 The  symbol will be displayed. Press  to confirm.

- 3 Remove accessories and the grease filter from the cooking compartment. Remove the wire racks from the cooking compartment (see → "Removing the wire racks" on page 37).
- 4 Once the cooking compartment has cooled down, spray it with cleaning gel spray (order number 00311860).
- 5 Fill the fresh water tank with cold water up to the "max." mark and then slide it all the way into the appliance.
- 6 Make sure that the used water tank is empty.
- 7 Close the appliance door.
- 8 The cleaning time will appear. Press  to start. The cleaning time will count down on the display. The light in the cooking compartment will remain switched off.
- 9 An audible signal will sound once the cleaning time has elapsed. A message will appear on the display.
- 10 Wipe out the cooking compartment.
- 11 Empty the fresh water tank and leave it to dry with the lid open.
- 12 Empty the used water tank and clean it in the dishwasher.

Wipe down the cooking compartment with a soft cloth and dry fully with the drying program.

### Notes

- The cleaning aid must always be run through completely and cannot be cancelled.
- Before cooking, remove any cleaning agent residue from the cooking compartment.
- If the cleaning aid was cancelled due to a power cut, it must be restarted before using the oven again in order to remove any cleaning agent residues from the appliance.

## Drying programme



With the drying program, you can dry the cooking compartment after cleaning or after steaming.

The drying program takes 20 minutes.

### Caution!

Do not dry the water tank in the hot oven interior. This would damage the water tank.

### Starting the drying program

- 1 Set the function selector to **S**. Select the drying program with the rotary selector.
- 2 The  symbol is displayed. Touch  to confirm.

- 3 The drying time of 20 minutes appears. Touch ▶ to start. The drying time elapses on the display. The lamp in the cooking compartment stays off.

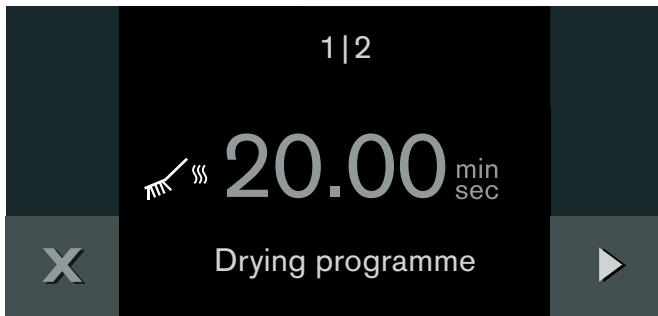

- 4 A signal sounds after 20 minutes. A message appears in the display. Touch ✓ to confirm.

The drying programme has ended. Allow the appliance to cool down. Then polish the cooking compartment and the panel with a soft cloth.

## Descaling programme

Regular descaling keeps the appliance in good condition. The descaling programme descales, rinses and dries the appliance fully automatically.

Depending on the type of water and your use of the appliance, a message in the display reminds you to run the descaling programme.

To prevent damage to the appliance, the operating modes that use steam are disabled after this message has been repeated. You can still use the appliance to run operating modes that do not require steam. Only once the descaling programme has been run can the appliance be used again without restrictions.

The descaling programme takes 1 hour 50 minutes from beginning to end.

For the descaling programme, you require special descaling tablets. These are available from the after-sales service or from our online shop (17002490, set with four descaling tablets).

### Caution!

- **Risk of damage to the appliance:** Limescale may damage the appliance. Descal the appliance regularly.
- **Risk of damage to the appliance:** Using the wrong descaler may damage the appliance. Only use the specified descaling tablets.
- **Damage to the cooking compartment:** Use the descaling tablet for the descaling programme only. Place the descaling tablet into the tank. Never place the descaling tablet in the cooking compartment or heat it up in the cooking compartment.

### Notes

- Remove all accessories from the cooking compartment before starting the descaling programme (wire rack, cooking containers, core temperature probe).
- The strainer filter must remain inserted in the cooking compartment floor while the descaling programme is in progress.
- Always allow the descaling programme to run to the end. The descaling programme cannot be cancelled.

### Starting the descaling program

- 1 Set the function selector to **S**. Use the rotary selector to select the descaling program.
- 2 The 🧽 symbol will be displayed. Press ✓ to confirm.
- 3 Remove all accessories from the cooking compartment. Press ✓ to confirm.
- 4 Remove the descaling tablet from the plastic packaging.

#### ⚠ Warning – Risk of injury!

Descaling tablets may cause chemical burns in the mouth, throat, eyes and on the skin. Follow the safety instructions on the packaging of the descaling tablets. Avoid the skin coming into contact with the descaling tablets. Keep children away from descaling tablets.

#### ⚠ Warning – Risk of injury!

The descaling solution may cause chemical burns in the mouth, throat and eyes or on the skin. Avoid the skin coming into contact with the descaling solution. Keep children away from descaling solution. Do not drink the descaling solution. The descaling solution must not come into contact with food. Rinse out the water tank thoroughly before you next use the appliance.

#### Caution!

#### Risk of damage to the appliance

Using the wrong descaler may damage the appliance. Only use the specified descaling tablets.

- 5 Remove the fresh water tank from the appliance and take off the lid.

- 6 Place the descaling tablet in the compartment at the back of the fresh water tank. Fill the fresh water tank with water up to the "Max." mark (1.7 litres).

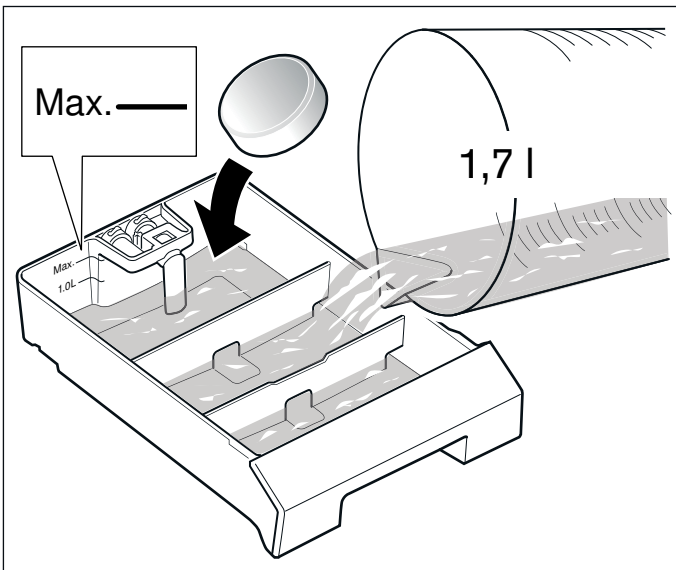

- 7 Position the lid on the fresh water tank and click it into place.
- 8 Slide the fresh water tank into the appliance.
- 9 Close the appliance door. Press to confirm. A descaling time of 1 hour 50 minutes is displayed.
- 10 Press to start. The descaling time will count down on the display. The light in the cooking compartment remains switched off.

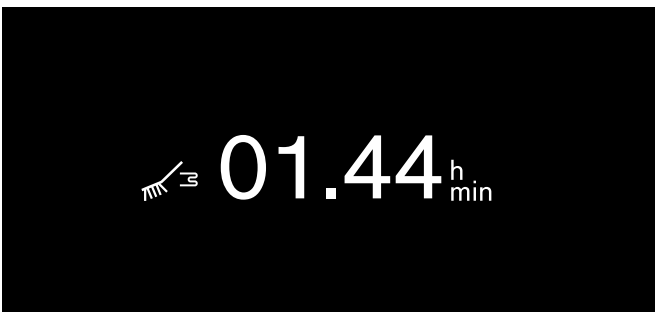

- 11 After 1 hour 30 minutes, a message appears in the display. Drain the used-water tank, clean it thoroughly and insert it into the appliance. Clean the fresh-water tank thoroughly, fill it with 1.7 l water and insert it into the appliance. Press to confirm.

**Warning – Risk of injury!**

The descaling solution may cause chemical burns in the mouth, throat and eyes or on the skin. Avoid the skin coming into contact with the descaling solution. Keep children away from descaling solution. Do not drink the descaling solution. The descaling solution must not come into contact with food. Rinse out the water tank thoroughly before you next use the appliance.

### Cleaning the tanks

Descaler residues are left in the fresh water tank and used water tank after descaling. You must therefore clean the fresh water tank and used water tank once the descaling program has ended.

- 1 Remove the fresh water tank and used water tank from the appliance and take off their lids.
- 2 Clean the fresh water tank, used water tank and tank lid in the dishwasher.

### Removing the wire racks

The wire racks can be removed for cleaning.

#### Removing the wire racks

- 1 Place a dishcloth in the cooking compartment to protect the enamel from scratches.
- 2 Undo the knurled nuts (Fig. A).
- 3 Lift the wire racks slightly sideways away from the screw and pull them out towards the front (Fig. B).

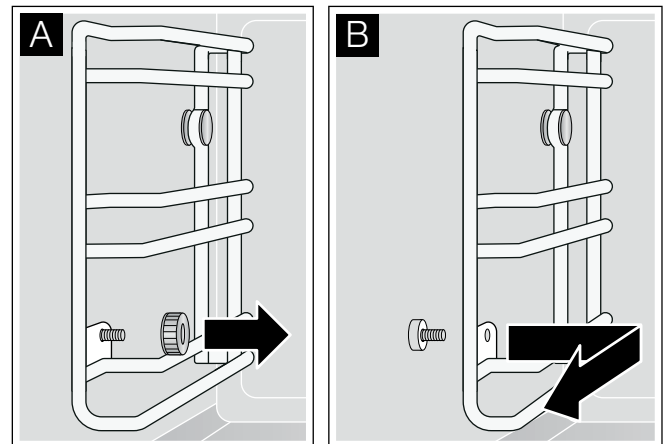

You can clean the wire racks in the dishwasher.

#### Refitting the wire racks

- 1 Attach the wire racks the right way round – with the end stop at the back.
- 2 Slide the back of wire racks onto the bolts, then reattach them at the front.
- 3 Tighten the knurled nuts.

**Note:** If a knurled nut is lost, you can order this from our after-sales service after as a spare part. The use of non-original knurled nuts may lead to corrosion in the cooking compartment.

## Trouble shooting

Malfunctions often have simple explanations. Please read the following notes before calling the after-sales service.

### Warning – Risk of electric shock!

Incorrect repairs are dangerous. Repairs may only be carried out and damaged power cables replaced by one of our trained after-sales technicians. If the appliance is defective, unplug the appliance from the mains or switch off the circuit breaker in the fuse box. Contact the after-sales service.

### Warning – Risk of injury!

The light emitted by LED lights is very dazzling, and can damage the eyes (risk group 1). Do not look directly into the switched on LED lights for longer than 100 seconds.

### LED lights

Defective LED lights must only be replaced by the manufacturer, their customer service department or a licensed technician (electrician).

Disruption	Possible cause	Solution
Appliance not working, no display	Plug not inserted	Connect the appliance to the electricity mains
	Power failure	Check whether other kitchen appliances are working
	Fuse defective	Check in the fuse box whether the fuse for the appliance is in working order
	Operating error	Switch off the fuse for the appliance in the fuse box and switch it on again after about 60 seconds
The appliance does not work, the display shows "Device locked. Descaling required."	Build-up of limescale in the appliance	Start the descaling programme → "Descaling programme" on page 36
Despite descaling, "Please descale" appears on the display	Build-up of limescale in the appliance, wrong descaler used	Use the specified descaling tablets, start the descaling programme → "Descaling programme" on page 36
Appliance cannot be started	Appliance door is not quite closed	Close appliance door
The appliance does not work, the display shows "E182"	No water available in the appliance	Take out the water tank and verify that the suction pipe in the tank is straight, not kinked. Please contact the after-sales service if the error message persists.
The appliance is not working and the display does not respond.  appears on the display	Childproof lock activated	Deactivating the childproof lock → "Childproof lock" on page 22
Appliance switches off on its own	Safety shut-off: the appliance has not been operated for longer than 12 hours	Confirm the message with  , switch off the appliance and set it again.
Appliance does not heat up,  appears in the display	Appliance is in demo mode	Deactivate the demo mode in the basic settings
The appliance cannot be started, the display shows an error message	The water tank is empty	Fill the water tank
The core temperature probe is inserted; 99 °C is displayed	Moisture on the core temperature probe shaft or on the socket in the cooking compartment	Move the core temperature probe shaft in and out of the socket in the cooking compartment several times
The core temperature probe is inserted but the  symbol is not displayed	Moisture on the socket in the cooking compartment	Move the core temperature probe shaft in and out of the socket in the cooking compartment several times
No steam visible in the oven	Steam above 100°C is invisible	This is normal
Powerful steam outlet at the top of the door	The operating mode has been changed	This is normal
A lot of steam escapes at the side of the door	Door seal soiled or loose	Clean the door seal and insert it in the groove

Humming noise when switching on	The appliance has not been used for a few days	Normal: Automatic rinsing during initial use
A whistling noise occurs during heating	Noises may occur during steam generation	This is normal
There is a "pop" noise during cooking	Cold/warm effect with frozen food, caused by the steam	This is normal
Steaming is not possible	Build-up of limescale in the appliance. Appliance must be descaled to avoid damage to the appliance	Starting the descaling program → <i>"Descaling programme" on page 36</i>
The appliance is not producing steam properly	Limescale has formed in the appliance	Start the descaling programme
The lighting is not working	The lighting is defective	Call the after-sales service
The used water tank cannot be removed	The used water tank remains locked for a short time after cooking has finished	Wait until it unlocks
Error message "Exxx"		If an error message is displayed, turn the function selector to <b>0</b> ; if the display goes out, there was a non-recurring problem. If the error occurs repeatedly or the display remains on, please contact the after-sales service and inform them of the error code.
Water drips out when you open the appliance door	The collecting channel on the underside of the door panel is full	Dry the collecting channel with a sponge

## Power cut

Your appliance can bridge a power cut of a few seconds. Operation continues.

If the power cut was for a longer period and the appliance was in operation, a message appears in the display. Operation is interrupted.

Set the function selector to **0**, then the appliance can be operated again as usual.

## Demo mode

The  symbol appears on the display when the appliance is in demo mode. The appliance will not heat up.

Briefly disconnect the appliance from the mains (switch off the household fuse or the circuit breaker in the fuse box). Then deactivate demo mode in the basic settings within 3 minutes.

## After-sales service

Our after-sales service is there for you if your appliance needs to be repaired. We will always find an appropriate solution, also in order to avoid after-sales personnel having to make unnecessary visits.

### E number and FD number

When calling us, please give the full product number (E no.) and the production number (FD no.) so that we can provide you with the correct advice. The rating plate bearing these numbers can be found when you open the appliance door.

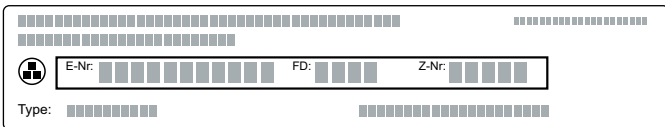

To save time, you can make a note of the number of your appliance and the telephone number of the after-sales service in the space below, should it be required.

E no.	FD no.

### After-sales service

Please note that a visit from an after-sales service engineer is not free of charge, even during the warranty period.

Please find the contact data of all countries in the enclosed customer service list.

#### To book an engineer visit and product advice

**GB** 0344 892 8988  
Calls charged at local or mobile rate.

**IE** 01450 2655  
0.03 € per minute at peak.  
Off peak 0.0088 € per minute.

**AU** 1300 368 339

**NZ** 09 477 0492

Trust the expertise of the manufacturer, and rest assured that the repair will be carried out by trained service technicians using original spare parts for your domestic appliance.

## Tables and tips

### Notes

- The cooking times specified are intended as a guide. The actual cooking time depends on the quality and temperature of the food before cooking, as well as its weight and thickness.
- The figures listed refer to average quantities of food for four people. If you wish to cook a larger quantity of food, you should allow for extra cooking time.
- Use the cookware specified. If you use other cookware, the cooking times may be longer or shorter.
- If you have not made a particular dish before, use the shortest time specified to start with. You can extend the cooking time if necessary.
- Open the door of the preheated oven for a short time only and quickly place your food inside the appliance.
- When using only one cooking container, place it in the appliance on the second level from the bottom.
- When steaming, defrosting, dough proving and reheating, you can use up to three shelf levels at a time (shelf levels 1, 2 and 3). This will not cause flavour to transfer. This allows fish, vegetables and desserts to be prepared at the same time. However, the specified cooking times may need to be extended for large quantities of food.
- If you are only baking on one level, use level 2. If you are baking on two levels at the same time, use levels 1 and 3.
- Do not allow the food to come into contact with the cooking compartment or the back panel of the oven.
- The combi-steam oven door must be able to shut properly. Keep the seal surfaces clean at all times.
- Do not place too many items close together on wire racks or in containers. This is to ensure an optimal steam circulation.
- When cooking very cold foods and when cooking at high temperatures, the cooking container may deform. This deformation does not impair its performance. When the cooking container cools down again, it returns to its original shape.
- If you wish to cook food using steam and the appliance has been heated to over 100 °C (for example because it has just been used for baking), allow the appliance to cool down before steaming your food. Otherwise, the high temperature will cause your food to dry out.



## Vegetables

- Vegetables are prepared better in steam than in boiling water: The taste, colour, and consistency are retained better. Virtually none of the water-soluble vitamins and nutrients are washed out. Since the combi-steam oven works without pressure at just 100 °C, the preparation is much gentler than in a pressure cooker, for example.
- All details refer to 1 kg washed vegetables.
- For steaming vegetables, use the perforated cooking insert; insert it in the second level from the bottom. Slide the unperforated cooking insert underneath it. Use the vegetable broth as the basis for a sauce or a vegetable stock.
- Blanching takes 8–10 minutes in the pre-heated appliance. If the vegetables or fruit will not be served immediately, chill in ice water to prevent continued cooking due to residual heat.
- When steaming at temperatures up to 100 °C, no preheating is necessary. Place the food in the cold cooking compartment and then switch on the appliance.

Food	Cooking container	Temperature in °C	Humidity in %	Cooking time in mins	Comments
Artichokes, large	Perforated	100	100	60–65	
Artichokes, small	Perforated	100	100	45–50	
Cauliflower, whole	Perforated	100	100	25–30	
Cauliflower, in florets	Perforated	100	100	15–25	
Beans, green	Perforated	100	100	35–50	
Broccoli, in florets (in accordance with EN 60350-1)	Perforated	90–100	100	20–25	Recipe tip: Serve with almonds that have been roasted in butter.
Chicory	Perforated	100	100	25–30	
Peas, fresh	Unperforated	100	100	25–30	Cover with water
Fennel, sliced	Perforated	100	100	20–25	
Vegetable terrine	Perforated/ wire rack	90	100	50–60	In a terrine mould
Peas, frozen (in accordance with EN 60350-1) (3 kg)	Perforated	100	100	35–45	
Carrots, in 0.5 cm slices	Perforated	100	100	20–25	
Potatoes, peeled and quartered	Perforated	100	100	30–35	
Kohlrabi, sliced	Perforated	100	100	25–35	
Leeks, sliced	Perforated	100	100	20–30	
Leeks, whole	Perforated	100	100	35–45	
Peppers, stuffed	Unperforated	180–200	80/100	20–25	Preheat. If stuffing with meat, sear the meat beforehand.
Unpeeled boiled potatoes (approx. 50 g/piece)	Perforated	100	100	30–35	
Unpeeled boiled potatoes (approx. 100 g/piece)	Perforated	100	100	35–40	
Brussels sprouts	Perforated	100	100	25–30	
Beetroot, sliced	Perforated	100	100	65–75	
Asparagus, green	Perforated	100	100	15–20	
Asparagus, white	Perforated	100	100	20–35	
Spinach	Perforated	100	100	8–12	Then sweat in a pan with onions and garlic.
Sweet potatoes, sliced	Perforated	100	100	15–20	
Peeling tomatoes	Perforated	100	100	3–4	Preheat. Cut the tomatoes, and rinse with ice-cold water after steaming.
Courgettes, sliced	Perforated	100	100	15–20	
Mangetout	Perforated	100	100	10–15	

## Fish

- Steaming is a cooking method that does not use any fat and does not allow fish to dry out.
- For food hygiene reasons, fish should have a core temperature of at least 62–65 °C after cooking. This is also the ideal cooking temperature.
- When steaming at temperatures of 90–100 °C, no preheating is necessary. Place the dish in the oven when it is cold and then switch on the appliance.
- Do not season the fish with salt until it is fully cooked. This will ensure that the natural flavour is retained and that less water is drawn out of the fish.
- When using the perforated cooking container, you can grease the container if the fish sticks too much.
- Place the unperforated cooking insert on the first level from the bottom to avoid getting fish stock on the cooking compartment surfaces.
- For fillets with skin, place the fish on the cooking insert or wire rack with the skin side up – this helps to retain its texture and flavour.

Food	Cooking container	Temperature in °C	Humidity in %	Cooking time in mins	Comments
Sea bream, whole (500 g each)	Perforated	100	100	20–30	Can be cooked in the swimming position if placed on half a potato.
Fish dumplings (20–40 g each)	Unperforated	90–100	100	8–12	Line the unperforated cooking container with greaseproof paper.
Prawns	Unperforated	80	100	10–12	
Lobster, cooked, removed from the shell, reheating	Perforated	70–80	100	10–15	
Carp, rare, whole (1.5 kg)	Perforated	90–100	100	35–45	In stock
Cod (250 g)	Unperforated	180	60	8–12	
Salmon fillet (150 g/piece)	Perforated	80	100	20–25	
Salmon, whole (2.5 kg)	Perforated	100	100	65–75	
Blue mussels (1.5 kg)	Perforated	100	100	12–15	Blue mussels are cooked once the shell has opened up.
Pollock, whole (800 g)	Perforated	90–100	100	20–25	
Monkfish fillet (300 g/piece)	Glass dish / wire rack	180–200	100	8–10	Preheating
Sea bass, whole (400 g/piece)	Perforated	90–100	100	20–25	

## Fish – low-temperature steaming

- If you steam the fish at between 70 and 90 °C, it is less likely to be overcooked or to fall apart. This is a particular advantage for delicate fish.
- The values given for the different types of fish refer to fillets.
- Place the unperforated cooking insert on the first level from the bottom to avoid getting fish stock on the cooking compartment surfaces.
- Serve on a pre-warmed dish.
- With low temperature steaming, no preheating is necessary. Place the dish into a cold oven and then switch on the appliance.

Food	Cooking container	Temperature in °C	Humidity in %	Cooking time in mins	Comments
Oysters (x 10)	Unperforated	80–90	100	7–10	In stock
Tilapia (150 g/piece)	Perforated	80–90	100	15–17	
Sea bream (200 g/piece)	Perforated	80–90	100	17–20	
Fish fillet (200–300 g/piece)	Perforated	80–90	100	17–20	
Fish terrine	Wire rack	80–90	100	50–90	In a terrine mould
Trout, whole (250 g/piece)	Perforated	80–90	100	17–20	
Halibut (300 g/piece)	Perforated	80–90	100	17–20	

Food	Cooking container	Temperature in °C	Humidity in %	Cooking time in mins	Comments
Scallops (15–30 g each)	Unperforated	80–90	100	9–13	The more the scallops weigh, the longer the chosen cooking time should be.
Cod (250 g/piece)	Perforated	80–90	100	15–17	
Red snapper (200 g each)	Perforated	80–90	100	17–20	
Ocean perch (120 g/piece)	Perforated	80–90	100	15–17	
Monkfish (200 g/piece)	Perforated	80–90	100	15–17	
Sole rolls, stuffed (150 g each)	Perforated	80–90	100	17–20	
Turbot (300 g/piece)	Perforated	80–90	100	17–20	
Sea bass (150 g/piece)	Perforated	80–90	100	15–17	
Pike-perch (250 g/piece)	Perforated	80–90	100	17–20	

## Meat – cooking at higher temperatures



- Combining steam and hot air is the best way of cooking many types of fish. In this operating mode, the cooking compartment is hermetically sealed and the moisture counteracts the drying effects of the hot air, which is used in conventional cooking. The optimal conditions can be achieved for any type of food thanks to the variable humidity control system.
- The cooking times listed are intended as a guide only and depend heavily on the temperature of the meat at the start of cooking and on how long the meat was seared for. Use the core temperature probe so that you can monitor the core temperature more easily. Information and optimum target temperatures can be found in the section entitled → *"Core temperature probe"* on page 26.
- Take the meat out of the refrigerator 1 hour before you begin preparing it.
- When using the perforated cooking insert or the wire rack, slide an unperforated cooking container beneath it. Pour a little water into the unperforated cooking insert to prevent the meat from burning on. You can also add vegetables, wine, spices and herbs to it to make a tasty base for a sauce.
- If you want the meat to be rare or medium rare, open the door when the temperature reaches 5 °C below the required core temperature and wait until the target temperature is reached. This prevents overcooking and allows the meat the necessary time to rest.
- Time to rest: Allow the meat to rest for 5 minutes on a wire rack after cooking. This gives the meat a chance to "relax". The meat juices begin to circulate less, and when the meat is cut, less juice is lost.







Food	Cooking container	Temperature in °C	Humidity in %	Cooking time in mins	Comments
Entrecôte, seared, medium rare (350 g/piece)	Unperforated	170–180	30	10–20	
Fillet, seared, medium rare, in puff pastry (600 g)	Unperforated	180–200	80	30–45	Line the cooking container with greaseproof paper.
Saddle of veal, seared, medium rare (1 kg)	Unperforated	160–180	30/60	20–30	If you have added liquid to the unperforated cooking container, 30% humidity is sufficient.
Smoked pork, cooked, sliced	Unperforated	100	100	15–20	
Roast pork with crackling (joint of pork with rind), well done (1.5 kg)	Wire rack + unperforated	1) 160 2) 230	80 	60 10	Cut the rind to form a cross-hatch pattern before cooking.  Use the core temperature probe: In the first stage of cooking, cook the food to a core temperature of up to approximately 65–70 °C, and in the second stage of cooking, cook it up to a core temperature of 70–75 °C.
Saddle of lamb, seared, medium rare (150 g/piece)	Unperforated	160–170	0/30	12–15	

Food	Cooking container	Temperature in °C	Humidity in %	Cooking time in mins	Comments
Leg of lamb, seared, medium rare (1.5 kg)	Unperforated	1) 200	30	30	
		2) 140	30	60–70	
Saddle of venison, seared, medium rare (500 g/piece)	Unperforated	160–170	0/30	12–18	
Joint of beef, well done (1.5 kg)	Wire rack + unperforated	1) 230	100	15	* If you have added liquid to the unperforated cooking container, 30% humidity is sufficient.
		2) 160	60*	60–90	
Sirloin, seared, medium rare (1 kg)	Unperforated	170–180	30	50–60	
Joint of pork (Neck or shoulder), well done (1–1.5 kg)	Wire rack + unperforated	1) 200–220	100	15	* If you have added liquid to the unperforated cooking container, 30% humidity is sufficient.
		2) 160–180	60*	40–60	
Sausages, boiled, heating	Unperforated	85–90	100	10–20	E.g. Bologna sausages, Bavarian veal sausages

## Meat/poultry – low-temperature cooking

- With low temperature cooking, the dishes are cooked at temperatures of between 60 and 80 °C and for a cooking time of a few minutes up to a several hours until cooked through. This cooking method is mainly used for meat and fish dishes. This preserves the sensory properties (e.g. tenderness and succulence) of the food. Heating it up gently gives the meat an even, delicate pink colour throughout (other than a very thin edge) and makes it extraordinarily succulent. You do not need to turn the meat during cooking or pour any liquid over it.
- The cooking times listed are intended as a guide only and depend heavily on the temperature of the meat at the start of cooking and on how long the meat was seared for. Use the core temperature probe so that you can monitor the core temperature more easily. Information and optimum target temperatures can be found in the section entitled → "Core temperature probe" on page 26.
- Take the meat out of the refrigerator 1 hour before you begin preparing it.
- For food hygiene reasons, sear the meat briefly on all sides at a high temperature in the frying pan before cooking it. This gives the meat a crust, which prevents the meat juices from escaping and produces the kind of flavour characteristic of a roast.
- Season with care: Because the meat develops as it cooks slowly, all of the flavours become more intense.
- When game and horse meat is cooked at low temperatures, its flavour becomes stronger than when prepared the conventional way.
- Use "Low temperature cooking" mode . In this mode, any moisture escaping from the food remains in the cooking compartment and prevents the food from drying out.
- With this operating mode, no preheating is necessary.
- Please note that the core temperature of the food cannot be higher than the temperature inside the cooking compartment. As a rule of thumb, the temperature that is set in the cooking compartment should be 10–15 °C above the required core temperature.
- Towards the end of the cooking time, you can reduce the temperature to 60 °C. This will allow you to extend the cooking time (e.g. if your guests arrive late). If you wish to pause cooking, the temperature in the cooking compartment must be no higher than the required core temperature. This means that large items can remain in the cooking compartment for 1–1.5 hours and small items can remain in there for 30–45 minutes.
- Serve on a pre-warmed dish.

Food	Cooking container	Temperature in °C	Type of heating	Cooking time in mins	Comments
Duck breast, medium rare (350 g/piece)	Unperforated	70–80		40–60	After cooking, you can crisp up the skin side quickly in the frying pan. Or: Grill + air recirculation 230 °C for 5 minutes.
Entrecôte, medium rare (350 g/piece)	Unperforated	70–80		40–70	

Food	Cooking container	Temperature in °C	Type of heating	Cooking time in mins	Comments
Fillet of veal, well done (1 kg)	Unperforated	80–90		150–200	
Leg of lamb, boned, tied, medium rare (1.5 kg)	Unperforated	70–80		180–240	Turn in garlic and herbs before cooking in oil
Fillet of beef, medium rare (1 kg)	Unperforated	70–80		120–180	
Beef steaks, medium rare (175 g/piece)	Unperforated	70–80		30–60	
Sirloin, medium rare (1–1.5 kg)	Unperforated	70–80		150–210	
Fillet of pork, well done (70 g each)	Unperforated	90		90–115	
Pork medallions, well done (70 g each)	Unperforated	80		50–70	

## Poultry

- The moisture present when the appliance is operating in combination mode prevents food from drying out, which is important for poultry in particular. At the same time, the high temperatures make the surface brown and crispy. The hot steam is able to transfer twice as much heat as conventional hot air, and reaches all parts of the food. This allows a chicken to be evenly browned and crispy all round, while the breast meat remains tender and succulent.
- The cooking times listed are intended as a guide only and depend heavily on the temperature of the meat at the start of cooking. Use the core temperature probe so that you can monitor the core temperature more easily. Insert this in the chicken breast rather than in the middle (cavity). Further information and optimum target temperatures can be found in the section entitled → "Core temperature probe" on page 26.
- To make the skin crispier, season poultry mainly with spices and herbs, and use little or no oil.

Food	Cooking container	Temperature in °C	Humidity in %	Cooking time in mins	Comments
Duck, whole (3 kg)	Unperforated	1) 150–160 2) 220	60 0	80–90 20–30	Cook with the breast side facing down. Turn the duck once half the cooking time has elapsed. This prevents the delicate breast meat from drying out as much.
Duck breast, seared, medium rare (350 g/piece)	Unperforated	160	0	25–30	
Chicken, whole (1.5 kg)	Wire rack + unperforated	1) 150 2) 230	100 	55–65 15	Tie the thighs together and cook breast side up.
Chicken breast, stuffed, steamed (200 g/piece)	Perforated	100	100	25–30	Do not preheat. Recipe tip: Stuff with spinach and sheep's cheese.
Turkey breast fillet, steamed (300 g/piece)	Perforated	100	100	17–25	Do not preheat.
Poussin, quail, steamed (150–200 g/piece)	Perforated	100	100	20–25	Do not preheat.
Poussin, quail (150–200 g/piece)	Unperforated	180–200	60/80	15–20	Recipe tip: Brush with oil and herbes de provence.
Pigeon, steamed (300 g/piece)	Perforated	100	100	25–35	Do not preheat.
Pigeon (300 g/piece)	Unperforated	180–200	60/80	25–30	

## Sous-vide cooking

Sous-vide cooking is a method of cooking under a vacuum at low temperatures between 50 and 95 °C and in 100% steam.

With this operating mode, no preheating is necessary.

Sous-vide cooking is a gentle, low-fat method of cooking meat, fish, vegetables and desserts. A vacuum-sealing machine uses heat to hermetically seal the food in a special heat-resistant cooking bag.

The protective envelope retains the nutrients and flavours. The low temperatures and the direct transfer of heat allow precisely controlled cooking in order to achieve the desired cooking results. It is almost impossible to overcook the food.

### Portions

Use the portion sizes listed in the cooking table. For relatively large quantities and items, the cooking time must be adjusted accordingly.

The portions given for fish, meat and poultry correspond to a single serving. A portion size sufficient for four people has been selected for vegetables and desserts.

### Rack levels

You can cook on up to two levels. Place the cooking containers on levels 1 and 3 to achieve the best cooking results. When cooking on just one level, use level 2.

### Hygiene

#### Warning – Health risk!

Sous-vide cooking is a method of cooking at low temperatures. As a result, it is important that you always follow the application and hygiene instructions below:

- Use only fresh, good-quality food.
- Wash and disinfect your hands. Use disposable gloves or cooking/grill tongs.
- Take extra care when preparing critical food, such as poultry, eggs and fish.
- Always thoroughly rinse and/or peel fruit and vegetables.
- Always keep work surfaces and chopping boards clean. Use different chopping boards for different types of food.
- Maintain the cold chain. Make sure that you only interrupt it briefly to prepare the food, and then return the food in its vacuum-sealed bag to the refrigerator for storage before you cook it.
- Food is suitable for immediate consumption only. Once the food is cooked, consume it immediately. Do not store it after cooking – not even in the refrigerator. It is not suitable for reheating.

### Vacuum-sealing bags

When using the sous-vide cooking method, only use heat-resistant vacuum-sealing bags designed for this purpose.

Do not cook the food in the bag you bought it in (e.g. portions of fish). These bags are not suitable for sous-vide cooking.

### Vacuum-sealing

Use a chamber vacuum-sealing machine that can create a 99% vacuum to vacuum-seal the food. This is the only way to achieve even heat transfer and therefore a perfect cooking result.

Before cooking the food, check whether the vacuum in the bag is intact. Make sure that:

- There is no/hardly any air in the vacuum-sealing bag.
- The heat-sealed seam is perfectly sealed.
- There are no holes in the vacuum-sealing bag. You do not use a core temperature probe.
- Pieces of meat and fish that have been vacuum-sealed together are not pressed directly against one another.
- As far as possible, you avoid piling up vegetables and desserts when vacuum-sealing them.

If in doubt, place the food into a new bag and vacuum-seal it again.

Food should be vacuum-sealed at most one day before it is cooked. This is the only way to prevent the escape of gases from the food (e.g. from vegetables) which inhibit the transfer of heat, or to prevent the texture of the food from changing, and thus altering how it cooks, as a result of the vacuum pressure.

### Quality of the food

The quality of the cooking result is 100% influenced by the quality of the ingredients you use. Use only fresh, top-quality food. This is the only way to guarantee a consistent cooking result that delivers impeccable flavour.

### Cooking

Sous-vide cooking prevents flavours from escaping, intensifying the food's natural flavour. Please note that the usual quantities of seasoning and condiments, such as herbs, spices and garlic, will have a much greater effect on the flavour. Start off by halving the quantities you usually use.

If the ingredients are of high quality, it is often sufficient to enclose them in the bag with just a small knob of butter and a little salt and pepper. Generally, the fact that the food's natural flavours intensify during cooking is sufficient on its own to produce a flavourful cooking result.

Do not place the vacuum-sealed food items on top of one another or too close together in the cooking containers. In order to ensure that the heat is distributed evenly, the food items should not be touching. If you have more than one vacuum-sealing bag, cook on two levels.

Remove the vacuum-sealing bags with care after cooking as hot water accumulates on the bags. Place the unperforated cooking container into the cooking compartment at the level below the perforated cooking container containing the hot food.

Dry the outside of the bag, place it into a clean, unperforated cooking container and cut it open with scissors. Place all of the food, along with its juices, into the cooking container.

**The food can be finished off as follows once the sous-vide cooking stage is complete:**















**Meat:** Flash fry at a very high temperature for a few seconds only on each side. This gives it a nice crust and the flavours you would expect from frying, without overcooking it. You can achieve a particularly good result using a teppan yaki or under the grill. Important: Dab the meat with a tea towel before placing it into hot oil, in order to avoid fat spitting out of the pan.



















**Vegetables:** Flash fry in a frying pan or on a teppan yaki to give them the flavours you would expect from frying. When frying vegetables like this, it is easy to season them or mix them with other ingredients without them cooling down.

**Fish:** Season and coat with hot butter. Since many types of fish fall apart easily after cooking using the sous-vide method, if you wish to flash fry fish, this should be done before the sous-vide cooking stage.

Fry the food for longer if has not been sufficiently well cooked during the sous-vide cooking stage.





Serve the food on pre-heated plates and, if possible, with a hot sauce or butter as sous-vide cooking takes place at relatively low temperatures.













Food	Cooking container	Temperature in °C	Type of heating	Cooking time in mins	Comments
<b>Meat</b>					
Entrecôte, rare (180 g/piece)	Perforated	58		100	Once the meat is cooked, sear it on a teppan yaki or grill it briefly at a high temperature on both sides. This gives the meat a nice crust and the flavours you would expect from frying, without overcooking it.
Entrecôte, medium rare (180 g/piece)	Perforated	63		90	
Entrecôte, well done (180 g)	Perforated	70		85	
Veal topside steaks (160 g each)	Perforated	60		80	
Beef steaks, rare (180 g each)	Perforated	58		60	
Beef steaks, medium rare (180 g each)	Perforated	63		50	
Beef steaks, well done (180 g each)	Perforated	70		45	
Pork medallions (80 g each)	Perforated	63		75	
<b>Poultry</b>					
Duck breast (350 g/piece)	Perforated	58		70	Once the breast is cooked, fry the skin side in a hot frying pan until it is crispy.
Foie gras (300 g/1 round)	Perforated	80		30	Recipe tip: Prepare the goose liver and mix it with other ingredients. Roll it in foil and prick it several times. Vacuum-seal the round and leave it to chill for several hours in the refrigerator before cooking it using the sous-vide method.
Chicken breast (250 g/piece)	Perforated	65		60	
<b>Fish and seafood</b>					
Prawns (125 g)	Perforated	60		30	Recipe tip: Vacuum-seal along with some olive oil, salt and garlic.
Scallops (20–50 g each)	Perforated	60		6–10	The more the scallops weigh, the longer the chosen cooking time should be.
Cod (140 g/piece)	Perforated	59		25	



Food	Cooking container	Temperature in °C	Type of heating	Cooking time in mins	Comments
Salmon fillet (140 g/piece)	Perforated	58		30	If you wish, you can flash fry the salmon fillet in a hot frying pan once it is cooked.
Pike-perch (140 g/piece)	Perforated	60		20	
<b>Vegetables</b>					
Mushrooms, quartered (500 g)	Perforated	85		20	Recipe tip: Vacuum-seal along with some butter, rosemary, garlic and salt.
Chicory, halved (4–6 pieces)	Perforated	85		40	Recipe tip: Cut the chicory in half. Vacuum-seal along with some orange juice, sugar, salt, butter and thyme.
White asparagus, whole (500 g)	Perforated	88		45	Recipe tip: Vacuum-seal along with some butter, salt and a little sugar.
Green asparagus, whole (600 g)	Perforated	85		15–20	Recipe tip: Blanch before vacuum-sealing to retain the colour. Vacuum-seal along with some butter, salt and pepper.
Carrots, in 0.5 cm slices (600 g)	Perforated	95		35–40	Recipe tip: Vacuum-seal along with some orange juice, curry and butter.
Potatoes, peeled, in 2 x 2 cm cubes (800 g)	Perforated	95		40	Recipe tip: Vacuum-seal along with some butter and salt. Can easily be used for making dishes such as salad.
Potatoes, skin on, whole or halved (800 g)	Perforated	95		50	Recipe tip: Vacuum-seal along with some butter and salt. Wash thoroughly beforehand.
Cherry tomatoes, whole or halved (500 g)	Perforated	85		15	Recipe tip: Vacuum-seal along with some olive oil, salt and sugar. Mix together red and yellow cherry tomatoes.
Squash, in 2 x 2 cm cubes (600 g)	Perforated	90		20–25	The cooking time may vary depending on the type of squash.
Courgettes, in 1 cm slices (600 g)	Perforated	85		30	Recipe tip: Vacuum-seal along with some olive oil, salt and thyme.
Mangetout, whole (500 g)	Perforated	85		5–10	Recipe tip: Vacuum-seal along with some butter and salt.
<b>Desserts</b>					
Pineapple, in 1.5 cm slices (400 g)	Perforated	85		70	Recipe tip: Vacuum-seal along with some butter, honey and vanilla.
Apple, peeled, in 0.5 cm slices (2–4)	Perforated	85		10–15	Recipe tip: Vacuum-seal along with some caramel sauce.
Bananas, whole (2–4)	Perforated	65		15–20	Recipe tip: Vacuum-seal along with some butter, honey and a vanilla pod.
Pear, peeled, sliced (2–4)	Perforated	85		30	Recipe tip: Add honey or sugar to sweeten.
Kumquats, halved (12–16)	Perforated	85		75	Recipe tip: Vacuum-seal along with some butter, a vanilla pod, honey and apricot jam. Rinse under warm water, cut in half and deseed.
Vanilla sauce (0.5 l)	Perforated	82		18–20	Recipe tip: 0.5 l milk, 1 egg, 3 egg yolks, 80 g sugar, 1 vanilla pod.



## Grilling

- A total of three grilling functions mean that you can brown or grill (full surface grill and air recirculation) your food to your requirements – or do both at the same time in a single step (full surface grill level 1 + humidity and full surface grill, setting 2 + humidity).
  -  | Browning with full surface grill + air recirculation at 230 °C:  
Also referred to as cooking au gratin. The last step in a cooking process. A brown crust forms on the surface of the food. Only takes a few minutes. The ingredients are already pre-cooked.
  -  | Full surface grill + air recirculation at 180–200 °C:  
Complete cooking process whereby the surface is toasted. The cooking process is longer than when browning. The ingredients must not be pre-cooked.
  -  -  Browning + grilling with full surface grill level 1 + humidity and full surface grill level 2 + humidity:  
With these two functions, food is simultaneously cooked and browned/two steps are carried out with one type of heating. The steam cooks the food, e.g. a potato gratin, and the second step browns it
- Do not grill food with the oven door open.
- With the full surface grill and air recirculation function, a pre-heating time of five minutes is sufficient. You do not need to wait until the temperature is reached. With the full surface grill and air recirculation function, the selected temperature may differ from the actual temperature in the appliance. Grilling is a rapid cooking process at high temperatures. Consequently, for browning and roasting, a higher temperature than is actually needed on the surface of the food is always selected.
- If you use the core temperature probe with the full surface grill with air recirculation or humidity with full surface grill functions, make sure that the core temperature probe is at least 5 cm away from the grill. Otherwise, the core temperature probe may be damaged.

Food	Cooking container, level	Temperature in °C	Type of heating	Cooking time in mins	Comments
Meringue topping (on cakes/desserts)	Wire rack 2	230		3–8	
Toast with topping	Wire rack + unperforated 2	200		12–15	
Trout (whole)	Wire rack + unperforated 2	230		12–15 On each side	Recipe tip: Stuff with sliced lemon and parsley.
Grilled aubergine, Sliced	Unperforated 2	200		20	
Grilled vegetables (700 g)	Unperforated 2	230		20–25	E.g. courgettes
Vegetable bake	Unperforated 2	190		30–35	E.g. with broccoli and cauliflower
Vegetable skewers	Wire rack + unperforated 2	230		15 on each side	The cooking time depends on the types of vegetable.
Chicken thighs (350 g each)	Wire rack + unperforated 2	180–200		35–40	
Hamburgers (125 g) in accordance with EN 60350-1	Wire rack + unperforated 2	230		12–15 on each side	Preheat for 5 minutes
Potato gratin (1 kg potatoes)	Wire rack/ unperforated 2	180		45–65	
Lasagne	Wire rack 2	180		40–45	
Sweet potatoes, sliced	Unperforated 2	200		15	

Food	Cooking container, level	Temperature in °C	Type of heating	Cooking time in mins	Comments
Toast in accordance with EN 60350-1	Wire rack 1	230		5–7	Preheat for 5 minutes.
Topped, grilled courgettes, stuffed, halved lengthways	Unperforated 2	180		30–40	

## Side dishes

Food	Cooking container	Temperature in °C	Humidity in %	Cooking time in mins	Comments
Basmati rice (250 g + 500 ml water)	Unperforated	100	100	20–25	
Bulgur wheat (250 g + 250 ml water)	Unperforated	100	100	10–15	
Couscous (250 g + 250 ml water)	Unperforated	100	100	10–15	
Dumplings (90 g each)	Perforated/ unperforated	95–100	100	25–30	
Long-grain rice (250 g + 500 ml water)	Unperforated	100	100	25–30	
Brown rice (250 g + 375 ml water)	Unperforated	100	100	30–35	
Polenta (250 g + 625 ml water for hard polenta) (250 g + 1125 ml water for soft polenta)	Unperforated	100	100	10–15	
Quinoa (250 g + 500 ml water)	Unperforated	100	100	30–40	
Risotto (250 g + 750 ml stock)	Unperforated	100	100	35–40	
Red beans	Unperforated	100	100	85–95	Soak for 1 hour. Cover with water.
Red lentils (250 g + 375 ml water)	Unperforated	100	100	15–20	
Lentils (250 g + 375 ml water)	Unperforated	100	100	50–60	
White beans, pre-soaked (250 g + 1 l water)	Unperforated	100	100	55–65	

## Desserts





Food	Cooking container	Temperature in °C	Humidity in %	Cooking time in mins	Comments
Crème brûlée (130 g each)	Perforated	90	80	55–65	
Steamed dumplings/yeast dumplings (100 g each)	Unperforated	100	100	20–30	Allow steamed dumplings to rise for 30 minutes before steaming. → "Dough proving (leaving to rise)" on page 53
Flan/crème caramel (130 g each)	Perforated	90	100	35–40	

Food	Cooking container	Temperature in °C	Humidity in %	Cooking time in mins	Comments
Compote	Unperforated	100	100	20–25	E.g. apples, pears, rhubarb Recipe tip: Add sugar, vanilla sugar, cinnamon or lemon juice.
Rice pudding (200 g rice + 800 ml milk)	Unperforated	100	100	55–60	Allow to cool down for 10 minutes and stir. Recipe tip: Add fruit, sugar or cinnamon.
Orange flan	Perforated	90	100	40–45	
Poached pears	Perforated	100	100	45–50	
Sweet bake	Unperforated	180–200	0/60	20–40	Preheating E.g. semolina, quark or pre-cooked rice pudding
Sweet soufflé	Unperforated	160	0	30	With fruit, chocolate, vanilla

## Miscellaneous

Food	Cooking container	Temperature in °C	Humidity in %	Cooking time in mins	Comments
Sterilising (e.g. baby bottles, jam jars)	Wire rack	100	100	20–25	
Drying fruit or vegetables	Perforated	80–100	0	180–300	E.g. thinly sliced tomatoes, mushrooms, courgettes, apples, pears, etc.
Eggs, hard-boiled	Perforated	100	100	13–15	Preheating
Eggs, medium	Perforated	100	100	7	Preheating
Eggs, soft-boiled	Perforated	100	100	4	Preheating
Royale (500 g)	Glass dish, wire rack	90	100	25–30	
Semolina dumplings	Unperforated	90–95	100	12–15	
Hot towels	Unperforated	100	100	10–15	Moisten the towels.
Potato gratin (1 kg potatoes)	Ovenproof dish, wire rack	180	30	45–65	
Lasagne	Unperforated	170–190	30/60	40–55	
Soufflé (cheese soufflé)	Soufflé dishes, wire rack	160	0	30	
Melting chocolate	Heat-resistant bowl, wire rack	60	100	15–20	Cover with heat-resistant cling film.

## Baked items



- With the combi-steam oven, you can always prepare your baked goods with the optimal humidity:
  -  | Hot air and 0% humidity:  
When baking fruit flan and quiche, excess humidity can escape. This operating mode corresponds to the hot air in the conventional baking oven.
  -  | Hot air and 30% humidity:  
Sponge cakes do not dry out. The humidity in the food cannot escape from the cooking compartment.
  -  -  | Hot air + 60 –100% humidity:  
Puff pastry and yeast-risen pastry are fluffy inside and crispy outside, with a gloss.
- If you only bake on one level, use level 2. If you bake on two levels at the same time, use levels 1 and 3. Slide the unperforated cooking insert into the second level. If you are using a deep baking tin, place it on the wire rack that you insert into the first level.
- With steam injection - possible in hot air mode (0% humidity) and humidity level 30% - humidity is fed to the food abruptly. Among other things, when used at the beginning of the baking process when baking bread or leavened cakes, this function ensures more volume and a crust which is crispier and shinier.

Food	Cooking container	Temperature in °C	Humidity in %	Cooking time in mins	Comments
Apple cake (in accordance with EN 60350-1)	20 cm springform cake tin, wire rack	160	0	110	Preheat
Bagels	Unperforated	190–210	80–100	20–25	
Baguette, pre-baked	Wire rack	190–200	0–80	10–15	
Sponge base, thick (6 eggs)	Springform tin	150	0	45	
Sponge base, thin (2 eggs)	Unperforated	200	100	8–10	E.g. for Swiss roll
Puff pastry goods	Unperforated	190–210	80–100	10–18	E.g. with poppy seeds, marzipan, or savoury with ham, cheese
Brioche, bread rolls	Unperforated	160	0	8–12	
Bread rolls (50–100 g/piece)	Unperforated	1) 150 2) 170–230	100 30	10 25	Step 2) 170 °C for light/230 °C for dark
Bread rolls, pre-baked	Wire rack	150–170	0	8–15	Inject steam at the beginning.
Bread (0.5–1 kg)	Unperforated	1) 150 2) 170–230	100 30	10 25–45	Step 2) 170 °C for light/230 °C for dark  Use the core temperature probe to monitor the exact cooking temperature. → Page 26  Place on the wire rack to cool.
Sponge traybakes	Unperforated	160–165	0	35–40	
Bundt cake (1 kg flour)	Bundt cake tin, wire rack	160–175	30	45–50	
Yeast tray bakes	Unperforated	160–170	0–60	30–45	For yeast tray bakes with moist toppings (e.g. plum tart or onion tart), use 0% humidity, and for yeast tray bakes with dry toppings (e.g. crumble), use 60% humidity.
Plaited loaf (500 g flour)	Unperforated	160–170	30	25–35	Inject steam at the beginning
Muffins	Muffin tin, wire rack	170	30	20–30	
Macaroons	Unperforated	150–160	0	15–20	
Biscuits	Unperforated	150–165	0	10–20	
Quiche, flan	Quiche dish or tin, wire rack	190–210	0	45–60	
Sponge cake	Loaf tin/ springform cake tin, wire rack	165–170	0–30	50–75	
Small cakes (in accordance with EN 60350-1)	Unperforated – level 2	160	0	25–30	Preheat
	Perforated – level 1	150	0	30–35	
	Unperforated – level 3				
Pastry strips (in accordance with EN 60350-1)	Unperforated – level 2	140	0	50	Preheat
	Perforated – level 1	140	0	50	
	Unperforated – level 3				

Food	Cooking container	Temperature in °C	Humidity in %	Cooking time in mins	Comments
Tart	Tart dish or tin, wire rack	190–200	0–30	30–45	E.g. with apples, chocolate, apricots, or savoury with asparagus, onions, cheese
Hot water sponge cake (in accordance with EN 60350-1)	Unperforated	150	0	40	Preheat
Cream puffs, eclairs	Unperforated	180–190	0–30	40–45	







## Dough proving (leaving to rise)

- The combi-steam oven provides the ideal conditions for proving dough and dough mixtures or raw pastries without them drying out.
- To do this, use the  "Dough proving" operating mode.
- With this operating mode, no preheating is necessary.
- The bowl does not need to be covered by a wet cloth. Proving only takes half as long as it usually does.
- The cooking time specified is intended as a guide only. Leave the dough to rise until it has doubled in volume.

Food	Cooking container	Temperature in °C	Type of heating	Cooking time in mins	Comments
Dough mixture – pizza	Bowl / wire rack	38		25	E.g. yeast dough, natural fermentation starter, sourdough
Dough mixture – bread	Bowl / wire rack	45		40	
Dough mixture – brioche	Bowl / wire rack	45		55	

## Regenerating (reheating)

- The combi-steam oven creates the perfect environment for reheating cooked food without drying it out. The flavour and quality are virtually indistinguishable from food that has been freshly prepared.
- To use this function, select "Reheat" mode .
- Do not cover the food. Do not use aluminium foil or clingfilm.
- The figures listed are for portions for one person. Larger quantities of food can also be warmed up in the unperforated cooking insert; you will need to cook the food for longer than the times specified in the table.

Food	Cooking container	Temperature in °C	Type of heating	Cooking time in mins	Comments
Baguette, bread rolls (frozen)	Wire rack	140		10–15	
Baguette, bread rolls (from previous day)	Wire rack	180		4–7	
Roasts, sliced (150 g/slice)	Unperforated	120		15–20	Finger-thick slices, do not pile them on top of one another; add sauce to the cooking container to make the roast more succulent.
Vegetables	Dish, wire rack	120		10–12	Do not preheat.
Pizza (from the previous day, not deep-frozen)	Wire rack	180		8–10	
Starchy side dishes	Dish, wire rack	120		8–12	E.g. pasta, quartered potatoes, rice; baked or fried food such as chips or croquettes are not suitable
Plated meals	Dish, wire rack	120		15–20	

## Defrosting

- In the combi-steam oven, you defrost frozen food gently and faster than in the refrigerator and more evenly than in the microwave.
- To do this, use the \* "Defrost" operating mode.
- With this operating mode, no preheating is necessary.
- The defrosting times specified are intended as a guide only. The defrosting time depends on the size, weight and shape of the frozen food: Freeze your food flat and in individual pieces. This will reduce the defrosting time.
- Remove the food from the packaging before defrosting.
- Only defrost the quantity that you need right away.
- Remember: Food that has been defrosted may not keep for as long as fresh food and it will spoil more quickly. Prepare defrosted food immediately and cook it thoroughly.

- After half of the defrosting time, turn fish or meat or separate pieces of frozen food, such as berries or pieces of meat. Fish does not need to be fully defrosted; it is sufficient to defrost it until the surface is soft enough for seasoning/spices to stick.

### Warning – Health risk!

When defrosting food from animal sources, you must remove the liquid that escapes during defrosting. It must never come into contact with other food. Bacteria could be transferred.

Slide the unperforated cooking insert under the food. Pour away the liquid that collects in the dish or tray as the meat and poultry defrosts. Then clean the sink and rinse it with plenty of water. Clean the cooking insert in hot soapy water or in the dishwasher.

After defrosting, operate the combi-steam oven for 15 minutes using hot air at 180 °C.

Food	Cooking container	Temperature in °C	Type of heating	Cooking time in mins	Comments
Berries (300 g)	Perforated	45–50	* ◊	6–8	
Roasts (1–1.5 kg)	Perforated	45–50	* ◊	90–120	
Fish fillet (150 g/piece)	Perforated	45–50	* ◊	15–20	
Vegetables (400 g)	Perforated	45–50	* ◊	10–12	
Goulash (600 g)	Perforated	45–50	* ◊	40–55	
Chicken (1 kg)	Perforated	45–50	* ◊	60–70	
Chicken thighs (400 g each)	Perforated	45–50	* ◊	40–50	

## Preserving

- It is easy to preserve fruit and vegetables in the combi-steam oven.
- Cook food as soon as possible after purchase or after it has been harvested. Prolonged storage reduces the vitamin content and can cause spoilage.
- Only use fruit and vegetables that are in good condition.
- The combi-steam oven is not suitable for preserving meat.
- Carefully check and clean the preserving jars, rubber sealing rings, clips and springs.
- Sterilise the washed jars in your combi-steam oven for 20–25 minutes at 100 °C and 100% humidity before preserving.
- Place the preserving jars in the perforated cooking container. They must not be in contact with each other.
- Once the cooking time has elapsed, open the cooking compartment door. Do not remove the preserving jars from the cooking compartment until they have completely cooled down.

Food	Cooking container	Temperature in °C	Humidity in %	Cooking time in mins	Comments
Fruit, vegetables (in sealed 0.75 l preserving jars)	Perforated	100	100	35–40	
Beans, peas (in sealed 0.75 l preserving jars)	Perforated	100	100	120	

## Extracting juice (soft fruit)

- The combi-steam oven lets you extract juice from berries effortlessly and cleanly.
- Place the berries into the perforated cooking insert and slide it into the 2nd level from the bottom. Slide the unperforated cooking insert one level underneath to catch any liquid that drips down.
- Leave the berries in the appliance until all the juice has been extracted.
- You can then place the berries in a tea towel and squeeze to extract the remaining juice.

Food	Cooking container	Temperature in °C	Humidity in %	Cooking time in mins	Comments
Berries	Perforated + unperforated	100	100	60–120	

## Preparing yoghurt

- You can even prepare your own yoghurt in the combi-steam oven.
- Heat pasteurised milk to 90 °C on the hob to prevent the yoghurt cultures from being overcome by any unwanted microbes. Ultra-heat treated milk (UHT milk) does not need to be heated. (Please note: If you use cold milk to make yoghurt, the incubation time will be longer).
- Important! Allow the milk to cool to 40 °C in a water bath so that the yoghurt cultures are not destroyed.
- Stir some natural yoghurt with identified yoghurt cultures into the milk (1–2 teaspoons of yoghurt per 100 ml).
- When using yoghurt ferment, follow the instructions on the packet.
- Pour the yoghurt into clean jars.
- You can sterilise the washed jars in your combi-steam oven at 100 °C and 100% humidity for 20–25 minutes before pouring in the yoghurt. Make sure that you allow the jars and the cooking compartment to cool down before you pour in the yoghurt and place the jars in the appliance.
- Once you have finished making the yoghurt, place it in the refrigerator.
- To make thick yoghurt, add skimmed milk powder to the milk before heating it (1–2 tablespoons per litre).

Food	Cooking container	Temperature in °C	Humidity in %	Cooking time in mins	Comments
Yoghurt starter (in sealed jars)	Perforated	45	100	300	Recipe tip: Flavour the yoghurt starter with fruit purée, jam, honey, vanilla or chocolate, and then increase the preparation time if necessary.

## Preparing bulky food

- To prepare bulky food items, you can remove the side slide-in racks.
- To do this, undo the knurled nuts at the front of the slide-in racks, and pull the slide-in racks out towards you.
- Place the wire rack directly onto the bottom of the cooking compartment and place the food or roasting dish onto the rack. Do not place the food or roasting dish directly onto the bottom of the cooking compartment.

## Acrylamide in foodstuffs

Which foods are affected?

Acrylamide is mainly produced in grain and potato products that are heated to high temperatures, such as crisps, chips, toast, bread rolls, bread, fine baked goods (biscuits, gingerbread, cookies).

### Tips for keeping acrylamide to a minimum when preparing food

General	Keep cooking times as short as possible. Cook food until it is golden brown, but not too dark. Large, thick pieces of food contain less acrylamide.
Baking	With hot air at max. 180 °C.
Biscuits	Egg or egg yolk reduces the production of acrylamide. Spread out a single layer evenly on the baking tray.
Oven Chips	Cook at least 400 g at once on a baking tray so that the chips do not dry out.

**Gaggenau Hausgeräte GmbH**  
Carl-Wery-Straße 34  
81739 München  
GERMANY  
www.gaggenau.com

Valid within Great Britain:

Imported to Great Britain by

BSH Home Appliances Ltd.  
Grand Union House  
Old Wolverton Road  
Wolverton, Milton Keynes  
MK12 5PT  
United Kingdom

9001346494 (001028)  
en

**GAGGENAU**

