

# REMOTE CONTROLLER (WIRED TYPE)

## OPERATING MANUAL

WIRED REMOTE CONTROLLER

Keep this manual for future reference.

English

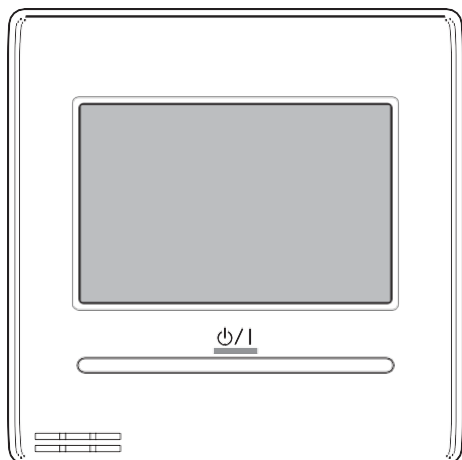

UTY-RNRYZ3  
UTY-RNRGZ3  
UTY-RNRXZ3



# OPERATING MANUAL

PART NO. 9380859819  
WIRED REMOTE CONTROLLER

## Contents

<b>INTRODUCTION</b>	
■ SAFETY PRECAUTIONS .....	3
■ SYSTEM OUTLINE .....	3
1 Terminology .....	3
2 Password configuration .....	4
3 Name of parts .....	4
<b>1 MONITOR</b>	
1-1 Monitor .....	5
1-1-1 Monitor mode screen .....	5
1-1-2 Status display .....	5
1-1-3 Child Lock .....	6
1-1-4 Emergency Stop .....	6
<b>2 CONTROL</b>	
2-1 On and Off .....	7
2-2 Operation Settings .....	7
2-2-1 Set the Operation Mode .....	7
2-2-2 Set the Temperature .....	7
2-2-3 Set the Fan Speed .....	7
<b>3 SETTING</b>	
3-1 Select the Setting Items .....	8
3-2 Comfort .....	8
3-3 Air Flow Direction Setting .....	8
3-3-1 VT Air Flow Direction .....	8
3-3-2 HZ Air Flow Direction .....	8
3-3-3 Individual Hold .....	9
3-4 Timer Setting .....	9
3-4-1 On Timer .....	10
3-4-2 Off Timer .....	10
3-4-3 Auto Off Timer .....	10
3-5 Weekly Timer Setting (for administrator) .....	11
3-5-1 Enable Schedule .....	11
3-5-2 Schedule Setting .....	12
3-5-3 Day Off Setting .....	13
3-6 Special Setting .....	13
3-6-1 Economy .....	14
3-6-2 Set Temp. Auto Return (for administrator) .....	14
3-6-3 Set Temp. Range Setting (for administrator) .....	14
3-6-4 Anti Freeze (for administrator) .....	15
3-6-5 Human Sensor Setting (for administrator) .....	15
3-6-6 Fan Control for Energy Saving (for administrator) .....	16
3-7 Summer Time (Daylight Saving Time) Setting (for administrator) .....	16
3-8 Preference (for administrator) .....	16
3-8-1 Panel Calibration .....	16
3-8-2 Backlight Setting .....	17
3-8-3 Contrast Setting .....	17
3-9 Initial Setting (for administrator) .....	17
3-9-1 Language Setting .....	18
3-9-2 Date Setting .....	18
3-9-3 Temp. Unit Setting .....	19
3-9-4 R.C.Group Name Setting .....	19
3-9-5 R.C. Sensor Setting .....	19
3-9-6 Password Setting .....	19
3-9-7 Display Item Setting .....	20
3-10 Maintenance (for administrator) .....	20
3-10-1 Error History .....	21
3-10-2 Setting Status List .....	21
3-10-3 Filter Sign Reset .....	21
3-10-4 Version .....	21
<b>4 OPERATION TIPS</b>	
4-1 Selectable Modes (for VRF system) .....	22
4-1-1 Heat recovery system .....	22
4-1-2 When indoor units is connected for cooling only in heat recovery system .....	22
4-1-3 RB priority connection in heatrecovery system ...	22
4-1-4 Heat pump system .....	22
4-1-5 Outdoor unit priority connection in heat pumps system ..	22
4-2 Verification screen when setting is complete ...	22
4-3 Settable temperature range .....	22
<b>5 OTHERS</b>	
5-1 Outline Dimensions .....	23
5-2 Specifications .....	23
5-3 Error Code .....	23



# INTRODUCTION

## ■ SAFETY PRECAUTIONS

- The "SAFETY PRECAUTIONS" indicated in the manual contain important information pertaining to your safety. Be sure to observe them.

 <b>WARNING</b>	This mark indicates procedures which, if improperly performed, might lead to the death or serious injury of the user.
In the event of a malfunction (burning smell, etc.), immediately stop operation, turn off the electrical breaker, and consult authorized service personnel.	
Do not repair or modify any damaged cable by yourself. Let the authorized service personnel to do it. Improper work will cause an electric shock or a fire.	
When moving, consult authorized service personnel for uninstallation and installation of this unit.	
Do not touch with wet hands. It may cause an electric shock.	
If children may approach the unit, take preventive measures so that they cannot reach the unit.	
Do not repair or modify by yourself. It may cause a fault or accident.	
Do not use flammable gases near the unit. It may cause a fire from leaking gas.	
Dispose of the packing materials safely. Tear and dispose of the plastic packing bags so that children cannot play with them. There is the danger of suffocation if children play with the original plastic bags.	
This appliance is not intended for use by persons (including children) with reduced physical, sensory or mental capabilities, or lack of experience and knowledge, unless they have been given supervision or instruction concerning use of the appliance by a person responsible for their safety. Children should be supervised to ensure that they do not play with the appliance.	

 <b>CAUTION</b>	This mark indicates procedures which, if improperly performed, might possibly result in personal harm to the user or damage to property.
Do not set vessels containing a liquid on this unit. Doing so will cause heating, fire or electric shock.	
Do not expose this unit directly to water. Doing so will cause trouble, electric shock or heating.	
Do not place electrical devices within 1 m (40 in) of this unit. It may cause malfunction or failure.	
Do not use fire near this unit or place a heating apparatus nearby. It may cause malfunction.	
Do not touch the switches with sharp objects. Doing so will cause injury, trouble, or electric shock.	
Do not insert articles into the slit parts of this unit. Doing so will cause trouble, heating, or electric shock.	

## ■ SYSTEM OUTLINE

### 1 Terminology

System related terms (◆ is for VRF system)

- (a) VRF system ◆:  
VRF (Variable Refrigerant Flow) is a large multi system that effectively air conditions a wide variety of spaces from large buildings to personal residences.
- (b) Other system:  
Multi or single type air conditioning system other than VRF system.
- (c) Heat recovery system ◆:  
The indoor unit connects to the outdoor unit via an RB unit in this system. RB units of single type and 4-system multi type are available. When a certain RB Group indoor units is performing cooling operation, other RB Group indoor units can perform heating operation. Please refer to (e) for RB Group. An indoor unit connected to an outdoor unit without going through an RB unit are for cooling only.
- (d) Heat pump system:  
This is standard system. In this system, the indoor units can not perform the cooling operation and the heating operation at the same time.
- (e) RB Group [for heat recovery system] ◆:  
A group of indoor units connected to a single type RB unit or each system of a multi type RB unit. In the RB Group, the indoor units can not perform cooling operation and heating operation at the same time.
- (f) R.C. Group (Remote Controller Group):  
This forms a group by connecting indoor units by remote controller cable. One indoor unit which is ungrouped is an R.C. Group, too. It is the minimum unit of operation.
- (g) Refrigeration system:  
This is a system composed of indoor units and outdoor units connected by the same refrigerant piping.
- (h) System ◆:  
This is 1 or 2 or more refrigerant systems connected by the same transmission cable.
- (i) Central controller ◆:  
A central remote controller can control multiple R.C. Groups. There is a system controller, Touch panel controller, and a central remote controller.
- (j) Standard remote controller:  
A standard remote controller can control 1 R.C. Group only. This unit corresponds to this. This unit cannot be used together with a 3-wire type wired remote controller. A wireless remote controller can be used together with this unit.
- (k) Custom Auto:  
Set both the cooling and heating temperatures. During the Custom Auto mode operation, when the room temperature exceeds the set temperature for cooling, the cooling operation is performed, and when the room temperature falls below the set temperature for heating, the heating operation is performed. (It can be used only when the setting of the indoor unit compatible with this function is valid.)
- (l) Deadband:  
The deadband is the minimum value of the difference between the set temperature for cooling and the set temperature for heating (= cooling set temperature - heating set temperature) in Custom Auto mode. The difference between the set temperature for cooling and heating in Custom Auto mode can not be smaller than the deadband. The deadband is set in the indoor unit. To change this, consult an authorized service personnel.

Address related terms

- (m) Indoor unit address ◆:  
This is an ID individually assigned to each indoor unit.
- (n) Remote controller address:  
This is an ID individually assigned separately from the indoor unit address to indoor units which form an R.C. Group.

## 2 Password configuration

This unit can set the following 2 kinds of passwords:

- (a) Password  
This is a password for administrator. Password is requested by the setting which requires management. For a description of password setting and change, refer to [3 SETTING] → [3-9 Initial Setting] → [3-9-6 Password Setting] .
- (b) Installer password  
This password is requested for important settings at installation.

### Note

If you forget your password, contact your local dealer.

## 3 Name of parts

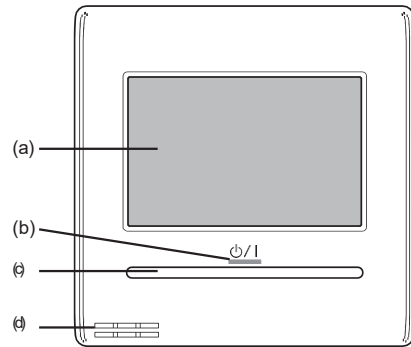

- (a) Touch panel display
  - When the screen is touched or the On/Off button is pressed while backlight is set to Enable, backlight lights. Backlight goes off 30 or 60 seconds after the last operation. When backlight is set to Disable, it does not light. For a description of backlight setting, refer to [3 SETTING] → [3-8 Preference] → [3-8-2 Backlight Setting].
  - Lightly touch the touch panel with your finger tips. A commercially available stylus pen can also be used. If pushed with too much force or operated with a rod, pencil, or ballpoint pen, etc., the display may be scratched or damaged.
  - Do not touch 2 or more places simultaneously. Correct operation cannot be performed.
  - When cleaning the touch panel display, setting child safety lock prevents erroneous operation. (Refer to [1 MONITOR] → [1-1 Monitor] → [1-1-3 Child Lock].) When cleaning, do not use detergent or alcohol, paint thinner, etc. It will cause accidents or loss of appearance.
- (b) LED lamp (Power indicator)  
Lights while the indoor unit is operating. Blinks when an error is generated.
- (c) On/Off button
- (d) Room temperature sensor (inside)  
Setting is necessary to use this sensor. Refer to [3 SETTING] → [3-9 Initial Setting] → [3-9-5 R.C. Sensor Setting].

# 1 MONITOR

## 1-1 Monitor

### 1-1-1 Monitor mode screen

Monitor mode screen is the home screen of this unit.

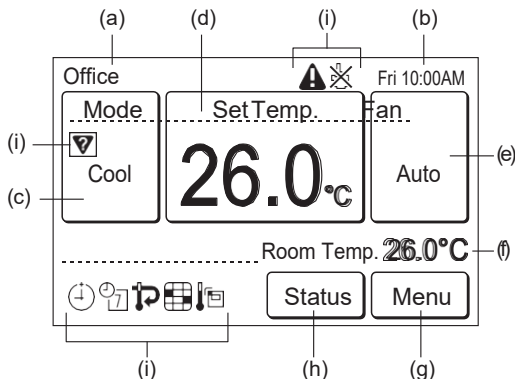

- (a) R.C. group name:  
Name of the remote controller group to which this unit is connected. Refer to [3 Setting] → [3-9 Initial Setting] → [3-9-4 R.C.Group Name Setting].
- (b) Clock:  
Refer to [3 SETTING] → [3-9 Initial Setting] → [3-9-2 Date Setting].
- (c) Mode:  
When this is touched, the display switches to the "Mode" screen. Refer to [2 CONTROL] → [2-2 Operation Settings] → [2-2-1 Set the Operation Mode].
- (d) Set temp.:  
When this is touched, the display switches to the temperature setting screen. Refer to [2 CONTROL] → [2-2 Operation Settings] → [2-2-2 Set the Temperature].  
When the operation mode is set to [Custom Auto], the set temperature is displayed for cooling and heating.
 

Set Temp.

Cool	28.0°C
Heat	20.0°C
- (e) Fan:  
When this is touched, the display switches to the fan speed setting screen. Refer to [2 CONTROL] → [2-2 Operation Settings] → [2-2-3 Set the Fan Speed].
- (f) Room temp.:  
The ambient temperature sensed by this unit is displayed. Refer to [3 SETTING] → [3-9 Initial Setting] → [3-9-7 Display Item Setting].
- (g) Menu:  
When this is touched, the display switches to the "Menu" screen. Refer to [3 SETTING].
- (h) Status:  
When this is touched, the display switches to the "Status" screen. Refer to [1-1-2 Status display].
- (i) Status icons:  
  - ⚠ An error occurred. Refer to [1-1-2 Status display] → < Error Information screen >.
  - ⊗ Operation from this unit is prohibited by the Central Controller. Refer to [1-1-2 Status display].

- ⚠ Mode mismatch. The mode which cannot operate simultaneously is selected. Refer to [1-1-2 Status display].
- ⌚ The On Timer, Off Timer, or Auto Off Timer is set. Refer to [3 SETTING] → [3-4 Timer Setting].
- 🕒 The weekly timer is set. Refer to [3 SETTING] → [3-5 Weekly Timer Setting].
- 🔁 The set temperature automatic return setting is set. Refer to [3 SETTING] → [3-6 Special Setting] → [3-6-2 Set Temp. Auto Return].
- 🧼 It shows that it is time to clean the filter. Refer to [3 SETTING] → [3-10 Maintenance] → [3-10-3 Filter Sign Reset].
- 🌡 The temperature sensor of this unit is used. Refer to [3 SETTING] → [3-9 Initial Setting] → [3-9-5 R.C. Sensor Setting].

For the screen display other than Chinese, this product uses a Bitmap font made and developed by Ricoh Company, Ltd.

### 1-1-2 Status display

The remote controller and indoor unit setting status are displayed.

Touch the [Status] on monitor mode screen. "Status" screen is displayed.

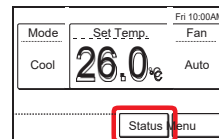

The "Status" screen has 2, 3 or 4 pages which are switched by touching the [Next Page] or [Previous Page]. When the [Monitor] is touched, the display returns to the monitor mode screen.

(\*: Items that indoor unit does not support are not displayed.)

< Page 1 >

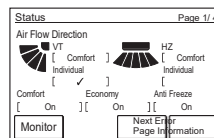

- Air Flow Direction\*:  
The air flow direction setting is displayed. The setting will appear only for indoor units which can set air flow directions. During comfortable air flow setting, [Comfort] is displayed. "Individual" is displayed only when this remote controller is connected to the indoor unit which supports the appropriate function. When setting is performed, [✓] is displayed. Refer to [3 Setting] → [3-3 Air Flow Direction Setting] → [3-3-3 Individual Hold].
- Comfort\*:  
ON or OFF of the comfort setting is displayed.
- Economy:  
ON or OFF of the economy setting is displayed.
- Anti Freeze\*:  
ON or OFF of the anti freeze setting is displayed.

< Page 2 >

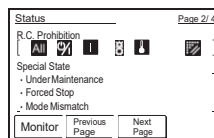

- R.C. Prohibition:  
The functions whose operation from this unit and Wireless type remote controller is prohibited by the Central Controller are displayed by icons. The contents of each icon are as follows:

- :All operations
- :On and Off
- :On
- :Mode setting
- :Temperature setting
- :Timer setting
- :Filter sign reset

When you try to operate or set the prohibited function, the following screen is displayed and operation or setting is not possible. When the [Close] is touched, the display returns to the screen before operation was performed.

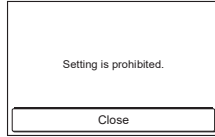

< Page 2 (to 3 or 4) >

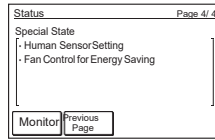
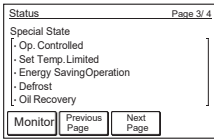

- Special State (Page 2, 3 or 4)  
The indoor unit status is displayed. When the contents to be displayed exceeds 3, they are displayed on the next page (Page 3 or 4). The status contents are as follows: (Only items that indoor unit supports or operating items are displayed.)

Under Maintenance:

Indoor unit is inspected. Indoor unit operation is stopped during this time.

Forced Stop:

Indoor unit is stopped forcibly by external input.

Mode Mismatch:

A mode which cannot be operated simultaneously with a master indoor unit or other operating indoor unit is set in the same RB group of a heat recovery system or in the same refrigerant system of a heat pump system. In this case, since the mode is switched to the fan mode, reset to a mode that can be operated simultaneously. Refer to [4 OPERATION TIPS]→[4.1 Selectable Modes] for the modes which can be operated simultaneously.

Operation Controlled:

This content is displayed at the Slave indoor unit when Master indoor unit is set in the refrigerant system or RB Group to which this unit is connected. When a Master indoor unit is not set, this shows that there is already another indoor unit operating. Only a mode set by Master indoor unit or a mode that can be operated simultaneously with another operating indoor unit can be selected. Refer to [4.OPERATION TIPS] for the modes which can be operated simultaneously.

Set Temp. Limited:

Indoor unit temperature setting is limited by the Central controller.

Energy Saving Operation:

The energy saving is set by the Energy Manager for System Controller.

Defrost:

At heating operation, the outdoor unit performs Defrost operation. The indoor unit fan is stopped during this time.

Oil Recovery:

The outdoor unit performs oil recovery operation. The indoor unit fan may be stopped during this time.

Human Sensor Setting:

This function is enabled. Refer to [3 SETTING]→[3-6 Special Setting]→[3-6-5 Human Sensor Setting].

Fan Control for Energy Saving:

This function is enabled. Refer to [3 SETTING]→[3-6 Special Setting]→[3-6-6 Fan Control for Energy Saving].

< Error Information screen >

[Error Information] is displayed only when there is an error history. When the [Error Information] is touched, the display switches to "Error Information" screen. Refer to [5-3 ERROR CODE] for the errors.

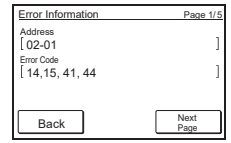
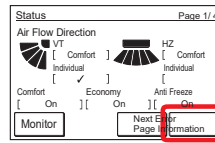

1-13 Child Lock

When this screen is displayed by touching the monitor mode screen, the unit is in child safety lock.



- Child safety lock set/reset:

Press the On/Off button for 4 seconds or more while touching an area outside the operation section of the monitor mode screen (no response even if touched). Set/reset can be performed even while the indoor unit is stopped. The setting cannot be performed at screens other than the monitor mode screen.

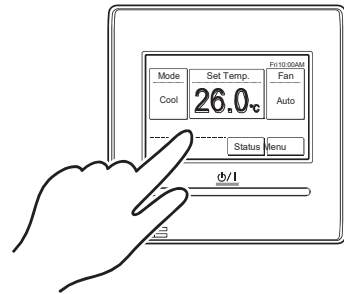

1-14 Emergency Stop

This screen is displayed when the system was emergency stopped by operation from the outside. When emergency stop is reset, the monitor mode screen is displayed.

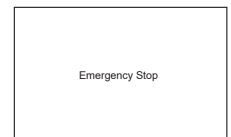



## 2 CONTROL

### 2-1 On and Off

- Press the [On/Off] button.

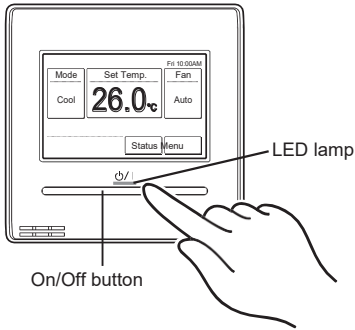

The LED lamp remains lit while the indoor unit is operating.

#### Note

The On/OFF button cannot be operated at screens other than the monitor mode screen.

### 2-2 Operation Settings

#### 2-2-1 Set the Operation Mode

- Touch the [Mode] on the monitor mode screen.
- "Mode" screen is displayed. Select the operation mode.

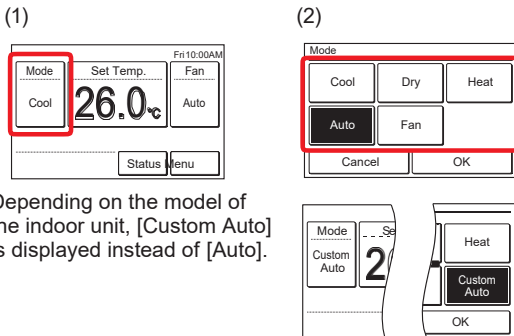

Depending on the model of the indoor unit, [Custom Auto] is displayed instead of [Auto].

#### Notes

- Only selectable modes are displayed. The selectable modes may be different depending on the system configuration and operation status. Refer to [4. OPERATION TIPS] → [4-1 Selectable modes].
- When the "Fan" is selected, the temperature cannot be set.
- [Auto] or [Custom Auto] mode can be used in the R.C. Group to which Master Indoor Unit is set. It is not displayed at other R.C. Group.
- When the operation mode is switched in a heat recovery system, operation preparations may take some time, but this is not a malfunction.

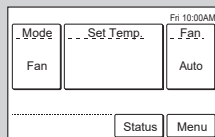

- When the [OK] is touched, the display returns to the monitor mode screen.

#### 2-2-2 Set the Temperature

- Touch the [Set Temp.] on the monitor mode screen.
- "Set Temp." screen is displayed. Adjust the room temperature with the [▲] or [▼].

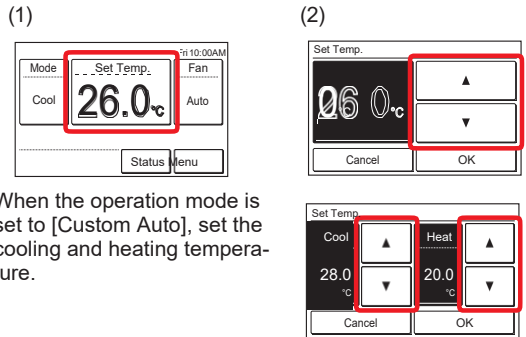

When the operation mode is set to [Custom Auto], set the cooling and heating temperature.

#### Notes

- The settable temperature range is different depending on the operation mode. Refer to [4 OPERATION TIPS] → [4-3 Selectable Temperature Range].
- When the "Set Temp. Range Setting" is set, the selectable temperature conforms to the setting. Refer to [3 SETTING] → [3-6 Special Setting] → [3-6-3 Set Temp. Range Setting].

- When the [OK] is touched, the display returns to the monitor mode screen.

#### 2-2-3 Set the Fan Speed

- Touch the [Fan] on the monitor mode screen.
- "Fan" screen is displayed. Select the fan speed with the [▲] or [▼].

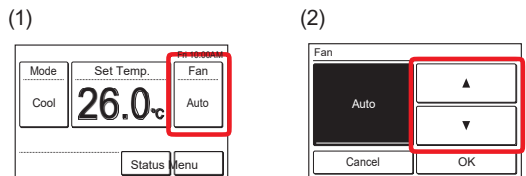

- When the [OK] is touched, the display returns to the monitor mode screen.

## 3 SETTING

### 3-1 Select the Setting Items

- Touch the [Menu] on the monitor mode screen.

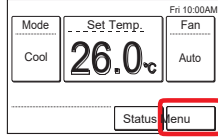

- “Main Menu” screen is displayed. The screen has 3 pages which are switched by touching the [Next Page] or [Previous Page]. (Items that indoor unit does not support are not displayed.)

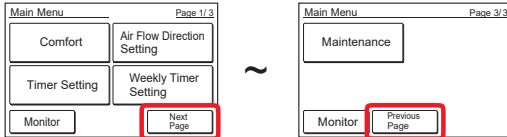

When the item to be set is touched, each setting screen is displayed. Refer to the description of each item for details. When each setting is complete or canceled, the display returns to this screen. When [Monitor] is touched, the display returns to the monitor mode screen.

### 3-2 Comfort

Air flow direction (vertical/horizontal) is set to provide air conditioning for the entire room. In the comfortable air flow mode, the air flow direction cannot be manually set because the air flow direction is fixed.

- Touch the [Comfort] on the “Main Menu” screen.

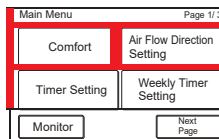

#### Note

For the indoor units without comfort function, [Comfort] is not displayed.

- “Comfort” screen is displayed. Touch the [On] or [Off] on the “Comfort” screen.

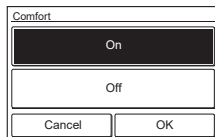

When you touch the [OK], the data is transmitted to the indoor unit, and then the display returns to “Main Menu” screen.

### 3-3 Air Flow Direction Setting

- Touch the [Air Flow Direction Setting] on the “Main Menu” screen.

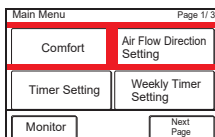

#### Note

For the indoor units without air flow direction adjustment function, [Air Flow Direction Setting] is not displayed.

- “Air Flow Direction Setting” screen is displayed. When the [VT Setting] or [HZ Setting] is touched, each setting screen is displayed.

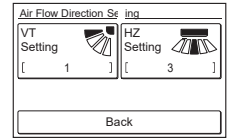

When the indoor unit does not have a horizontal air flow direction adjustment function, [HZ Setting] is not displayed and the air flow direction cannot be set.

When this remote controller is connected to the cassette type indoor unit with individual air flow control function, [Individual Hold] is displayed.

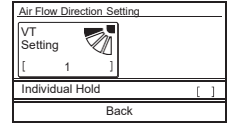

For this operation, refer to “3-3-3 Individual Hold”.

When the [OK] or [Cancel] is touched at each setting screen, the display returns to this screen. When [Back] is touched, the display returns to the “Main Menu” screen.

#### Note

When using this unit together with a wireless remote controller, the air flow direction of the indoor unit may not match the direction indicated on this unit.

### 3-3-1 VT Air Flow Direction

- Touch the [VT Setting] on the “Air Flow Direction Setting” screen.
- “VT Air Flow Direction Setting” screen is displayed. Touch [▲] or [▼] and set the air flow direction or “Swing”.

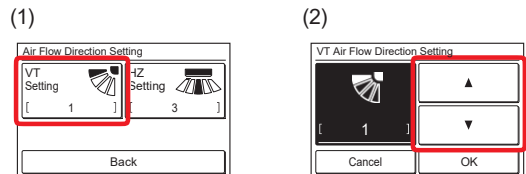

- When the [OK] is touched after setting, the data is transmitted to the indoor unit and the display returns to the “Air Flow Direction Setting” screen.

### 3-3-2 HZ Air Flow Direction

- Touch the [HZ Setting] on the “Air Flow Direction Setting” screen.
- “HZ Air Flow Direction Setting” screen is displayed. Touch [▶] or [◀] and set the air flow direction or “Swing”.

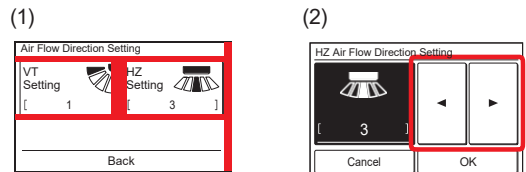

- When the [OK] is touched, after the data is transmitted to the indoor unit, the display returns to the “Air Flow Direction Setting” screen.

### 3-3-3 Individual Hold

“Individual Hold” can be used only with cassette type indoor unit which supports this function. The air flow direction can be set for each outlet of single or multiple indoor units connected to this remote controller.

- Touch the [Individual Hold] on the “Air Flow Direction Setting” screen.

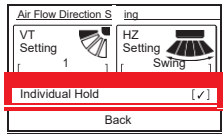

- Touch the unit number you want to set on the “Individual Hold” screen.

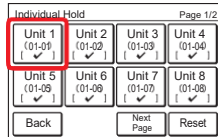

\* [Comfort] is set to the shaded indoor unit as shown (2a) below. When it is touched, the message is displayed as shown (2b) below.

(2a)

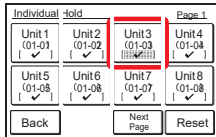

(2b)

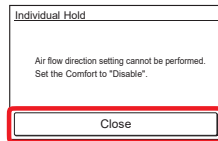

\* When multiple indoor units are connected to this remote controller, the indoor unit selection screen is displayed. When the screen (2) has 2 pages, they can be switched by touching the [Next Page] or [Previous Page]. When this remote controller is connected to multiple indoor units, the address (XX-XX) is displayed for each indoor unit. Touch the indoor unit to be set. [✓] is displayed at the set indoor units.

#### Notes

- To clear the air flow direction setting of all the displayed indoor units, touch [Reset]. When [Yes] of the confirmation screen is touched, the setting is cleared and switches to the air flow direction setting of “VT setting” (Refer to 3-3-1).
- When you want to change the order of the indoor units displayed on the indoor unit selection screen, consult your installer or service personnel.

- The outlet port selection screen that sets the air flow direction is displayed. Touch the outlet port to be set.

#### Cassette type

Check the position of each outlet port based on “◆” mark of the indoor unit body.

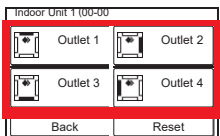

Position of the mark

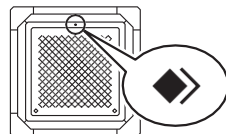

#### Note

- To clear all outlet port settings of selected indoor units, touch [Reset]. When [Yes] of the confirmation screen is touched, the setting is cleared and switches to the air flow direction setting of “VT setting” (Refer to 3-3-1).

#### 3D flow cassette type

The number of outlet port differs depending on the model.

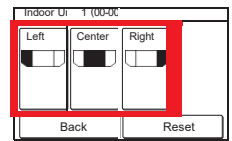
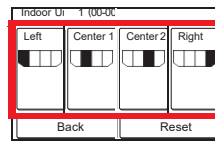

- The air flow direction setting screen is displayed. Touch [VT] or [HZ].

When the indoor unit does not have a flow direction adjustment function (vertical/horizontal), [VT Setting]/[HZ Setting] is not displayed and the air flow direction cannot be set.

#### VT Setting

“VT Air Flow Direction Setting” screen is displayed. Touch [▲] or [▼] and set the air flow direction or “Swing”.

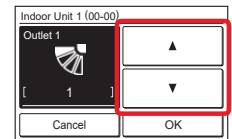
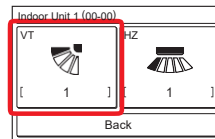

#### HZ Setting

“HZ Air Flow Direction Setting” screen is displayed. Touch [▶] or [◀] and set the air flow direction or “Swing”.

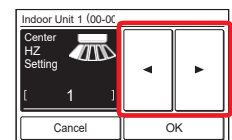
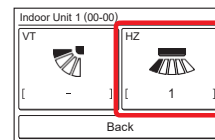

#### Note

- When the air flow direction setting of “VT setting” (Refer to 3-3-1) or “HZ setting” (Refer to 3-3-2) is set at the outlet port, “—” is displayed at the outlet port screen.

### 3-4 Timer Setting

- Touch the [Timer Setting] on the “Main Menu” screen.
- “Timer Setting” screen is displayed.

(1)

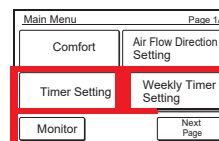

(2)

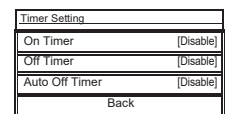

The following timer settings are possible:

- On Timer:**  
The stopped indoor unit starts to operate after the set time.
- Off Timer:**  
The operating indoor unit stops to operate after the set time.
- Auto Off Timer:**  
When indoor unit operation is started by the On/Off button of this unit, operation stops after the set time.

When the item to be set is touched, the display switches to each setting screen. When each setting is complete or canceled, the display returns to this screen. When [Back] is touched, the display returns to the “Main Menu” screen.

### 3-4-1 On Timer

- Touch the [On Timer] on the "Timer Setting" screen. When the "Password Verification" screen is displayed, enter the password and touch [OK].

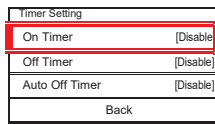

#### Enable the On Timer.

- "On Timer" screen is displayed. Touch the [Enable/Disable] on the "On Timer" screen.
- "Enable/Disable" screen is displayed. Touch the [Enable].

(2)

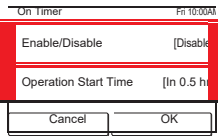

(3)

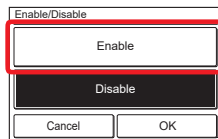

When the [OK] is touched, the display returns to the "On Timer" screen.

#### Set the Operation Start Time

- Touch the [Operation Start time] on the "On Timer" screen. "Operation Start time" screen is displayed.
- Set the time by touching [▲] or [▼].

(4)

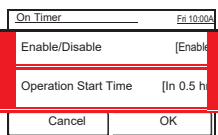

(5)

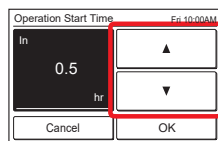

When the [OK] is touched, the display returns to the "On Timer" screen.

#### Note

Up to 24 hours can be set.

#### Apply the setting.

- Touch the [OK] on the "On Timer" screen. After the setting change screen is displayed, the display returns to the "Timer Setting" screen.

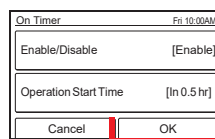

### 3-4-2 Off Timer

- Touch the [Off Timer] on the "Timer Setting" screen. When the "Password Verification" screen is displayed, enter the password and touch [OK].

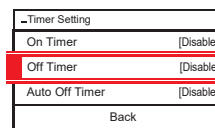

#### Enable the Off Timer.

- "Off Timer" screen is displayed. Touch the [Enable/Disable].
- "Enable/Disable" screen is displayed. Touch the [Enable].

(2)

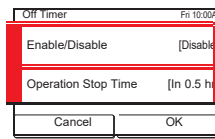

(3)

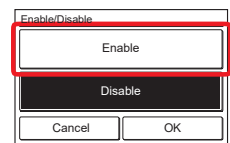

When the [OK] is touched, the display returns to the "Off Timer" screen.

#### Set the Operation Stop Time

- Touch the [Operation Stop time] on the "Off Timer" screen. "Operation Stop Time" screen is displayed.
- Set the time by touching [▲] or [▼].

(4)

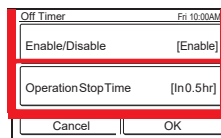

(5)

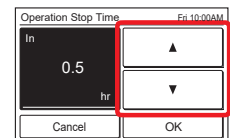

When [OK] is touched, the display returns to the "Off Timer" screen.

#### Note

Up to 24 hours can be set.

#### Apply the setting.

- Touch the [OK] on the "Off Timer" screen. After the setting change screen is displayed, the display returns to the "Timer Setting" screen.

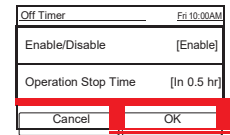

### 3-4-3 Auto Off Timer

- Touch the [Auto Off Timer] on the "Timer Setting" screen. When the "Password Verification" screen is displayed, enter the password and touch [OK].

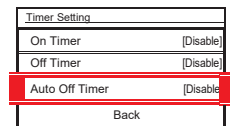

#### Enable the Auto Off Timer.

- "Auto Off Timer" screen is displayed. Touch the [Enable/Disable] on the "Auto Off Timer" screen.
- "Enable/Disable" screen is displayed. Touch the [Enable].

(2)

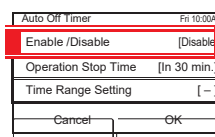

(3)

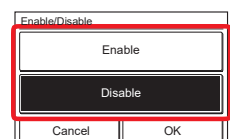

When the [OK] is touched, the display returns to the "Auto Off Timer" screen.

#### Set the Operation Stop Time

- Touch the [Operation Stop time] on the "Auto Off Timer" screen.
- The "Operation Stop" time screen is displayed. Set the time with [▲] or [▼]. The time can be set within the 30 to 240 min. range in 10 min. increments.

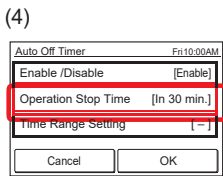

When the [OK] is touched, the display returns to the "Auto Off Timer" screen.

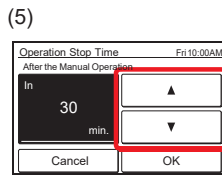

### Set the time range of Auto Off Timer

- (6) Touch the [Time Range Setting] on the "Auto Off Timer" screen.
- (7) "Time Range Setting" screen is displayed. Touch the [Time Range].

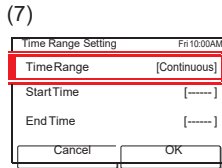
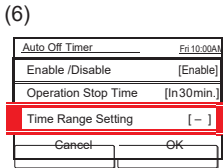

- (8) "Time Range" is displayed. When specifying a time range for the "Auto Off Timer", touch [Range Spec.] and when enabling the setting all day, touch [Continuous].

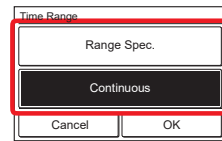

When the [OK] is touched, the display returns to the "Time Range Setting" screen. When the [Continuous] is selected, go to (14).

- (9) Touch the [Start Time] on the "Time Range Setting" screen.
- (10) "Start Time" screen is displayed. Set the Start Time by touching [▲] or [▼] on the "Start Time" screen.

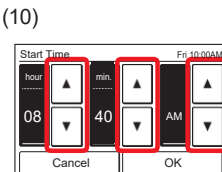
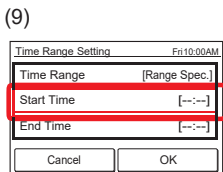

When the [OK] is touched, the display returns to the "Time Range Setting" screen.

### Note

Setting screen format corresponds to the preference of the "Display format Setting".

- (11) Touch the [End Time] on the "Time Range Setting" screen.
- (12) "End Time" screen is displayed. Set the End Time by touching [▲] or [▼].

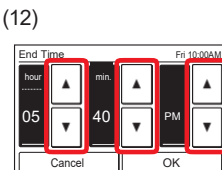
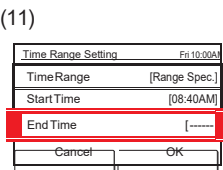

When the [OK] is touched, the display returns to the "Time Range Setting" screen.

- (13) Touch the [OK] on the "Time Range Setting" screen. The display returns to the "Auto Off Timer" screen.

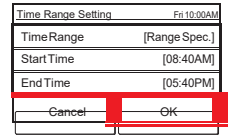

### Apply the setting.

- (14) Touch the [OK] on the "Auto Off Timer" screen. After the setting change screen is displayed, the display returns to the "Timer Setting" screen.

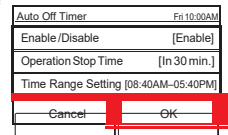

## 3-5 Weekly Timer Setting (for administrator)

Weekly operation schedule can be set. Two schedule patterns can be created. Up to 8 times setting for each day can be set.

- (1) Touch the [Weekly Timer Setting] on the "Main Menu" screen. After the "Password Verification" screen is displayed, enter the password and touch [OK].
- (2) "Weekly Timer Setting" screen is displayed.

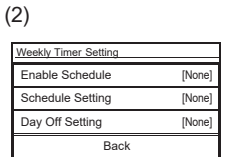
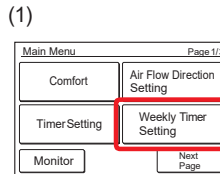

The following contents are set:

- Enable Schedule:  
The schedule to be used is selected or the Weekly Timer is disabled temporarily.
- Schedule Setting:  
The daily operating schedule is created. Two schedule patterns can be created. Up to 8 times setting for each day can be set.
- Day Off Setting:  
Weekly Timer can be disabled for any day within a range of 1 week. This is convenient when operation is not necessary on holidays, etc. When the set day has passed, its setting is cleared.

When the item to be set is touched, each setting screen is displayed. Refer to the description of each item for details. When each setting is complete or canceled, the display returns to this screen. When [Back] is touched, the display returns to the "Main Menu" screen.

### 3-5-1 Enable Schedule

#### Select the schedule to be used.

- (1) Touch the [Enable Schedule] on the "Weekly Timer Setting" screen.
- (2) "Enable Schedule" screen is displayed. Select and touch [Schedule 1] or [Schedule 2].

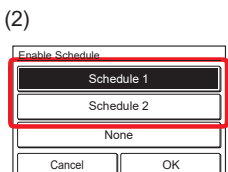
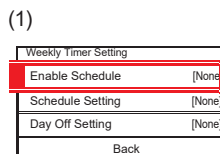

- (3) When the [OK] is touched, after a setting change screen is displayed, the display returns to the "Weekly Timer Setting" screen.

### Note

To disable use of a schedule already set, touch [None] at screen of (2).

### Note

Setting screen format corresponds to the preference of the "Display format Setting".

- (8) Touch the [On/Off] on the screen of (6), and select the [On],[Off] or [Hold].

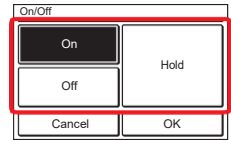

When the [OK] is touched, the display returns to the screen of (6).

### Note

When the [Hold] is selected, the state of the indoor unit immediately before timer operation is held. When On/Off operation and setting were changed manually before timer operation, the new operation and settings are held.

- (9) Touch the [Mode] on the screen of (6), and select the operation mode.

When the [OK] is touched, the display returns to the screen of (6).

- (10) Touch the [Set. Temp] on the screen of (6), and adjust the room temperature with [▲] or [▼].

When the [OK] is touched, the display returns to the screen of (6).

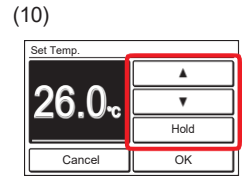
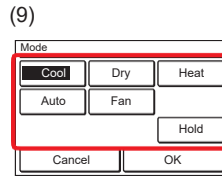

If you set the operation mode to [Custom Auto] or [Hold], set the cooling and heating temperature.

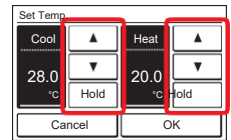

## 3-5-2 Schedule Setting

### Select the schedule to be set.

- (1) Touch the [Schedule Setting] on the "Weekly Timer Setting" screen.
- (2) "Schedule Setting" screen is displayed. When the [Schedule 1] or [Schedule 2] is touched, each setting screen is displayed.

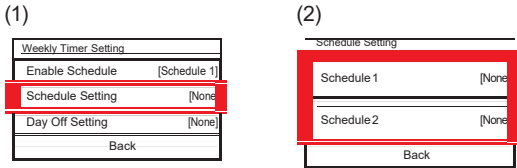

### Select the day of the week

- (3) Select by touching the day of the week on which schedule operation is to be performed. The settings for 4 times is displayed on this screen. When the contents are verified, switch the page by touching the [Next Page] or [Previous Page].
- (4) When the schedule display area is touched, the display switches to the setting screen of each day of the week.

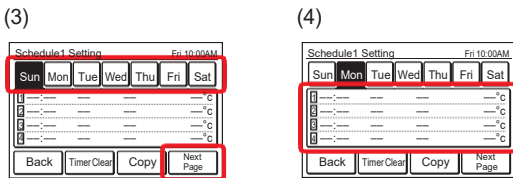

### Set the schedule for each day of the week.

- (5) The setting screen for each day of the week has 3 pages which are switched by touching the [Next Page] or [Previous Page]. Setting of up to 3 times can be displayed on 1 page.
- By touching each time from [1] to [8], detailed settings for that time can be set.
- (6) The items that can be set for one time are the [Op. Time], [On/Off], [Mode], and [Set. Temp.]. When each item is touched, each setting screen is displayed. To clear the setting of the selected time touch [Clear]. When the [Clear] is touched, a verification screen is displayed. When the [Yes] is touched on the screen, the setting is cleared.
- (7) Touch the [Op. Time] on the screen of (6), and adjust the time with [▲] or [▼].

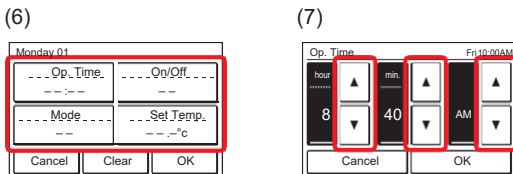
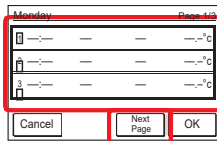

When the [OK] is touched, the display returns to the screen of (6).

### <Example program>

		Time	On/Off	Mode	Temp.
Morning	[1]	08:00 AM	On	Dry	28 °C
	[2]	10:00 AM	Hold	Cool	26 °C
Afternoon	[3]	12:00 PM	Hold	Hold	24 °C
	[4]	3:00 PM	Off	—	—
Night	[5]	5:00 PM	On	Hold	Hold
	[6]	7:00 PM	Hold	Hold	26 °C
	[7]	9:00 PM	Off	—	—
—	[8]	—	—	—	—

### End the setting of each day of the week.

- (11) When the [OK] on the screen of (6) is touched, the display returns to the screen of (5). When continuing setting of the same day of the week, repeat (5) to (11).

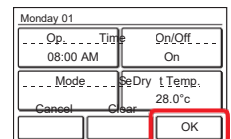

When the [OK] on the screen of (5) is touched, the display returns to the screen of (3).

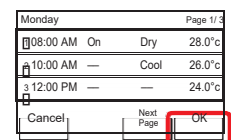

A bar is displayed above the day of the week with a schedule set.

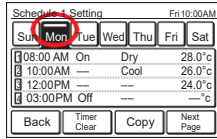

When performing a different setting for other days of the week, repeat (3) to (11).

### Copy the setting of each day of the week.

(12) The contents of setting performed at a certain day of the week can be copied to other days of the week. Touch the day of the week to be copied and touch the [Copy].

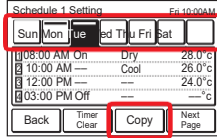

Next, touch the day of the week to be pasted. When the [Paste] is touched, a dotted bar is displayed over the day of the week to be pasted. Continue to paste to other days of the week.

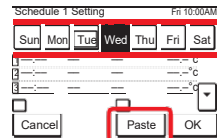

To cancel the paste, touch the selected day of week and touch the [Paste Clear]. When the [OK] is touched, a verification screen is displayed.

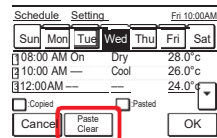

When the [Yes] on the verification screen is touched, the setting is pasted.

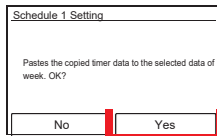

### Clear a day of the week setting.

To clear the setting contents of each day of the week, select the objective day of the week and touch the [Timer Clear].

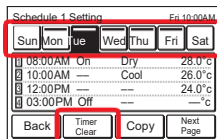

A verification screen is displayed. When the [Yes] is touched, the setting is cleared.

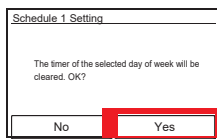

### End the schedule setting.

When the [Back] is touched, the display returns to the screen of (2).

When the [Back] on the screen of (2) is touched, the display returns to the screen of (1).

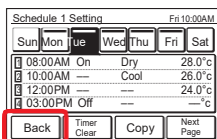

(1)

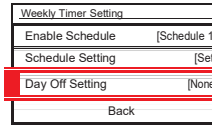

(2)

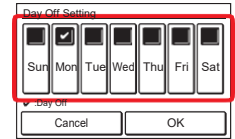

When setting is complete, touch the [OK]. After the setting complete screen is displayed, the display returns to the "Weekly Timer Setting" screen.

## 3-6 Special Setting

(1) Touch the [Special Setting] on the "Main Menu" screen.

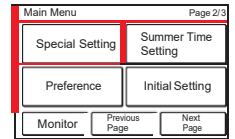

(2) "Special Setting" screen is displayed. When the screen has multiple pages, they can be switched by touching the [Next Page] or [Previous Page].

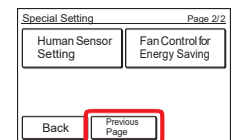
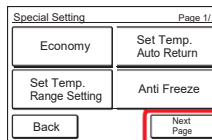

The following contents are set:

(\*: Items that indoor unit does not support are not displayed.)

#### • Economy:

The temperature setting is offset automatically over a certain period of time. The power consumption is suppressed by setting the temperature high during cooling and low during heating.

#### • Set Temp. Auto Return (for administrator):

Even if the temperature setting is changed during Cool or Heat mode operation, after the set time, the temperature automatically returns to the set temperature.

#### • Set Temp. Range Setting (for administrator):

Power consumption by excessive temperature setting is suppressed by restricting the temperature setting range for each operation mode of Auto, Cool/Dry, or Heat.

#### • Anti Freeze\* (for administrator):

Anti Freeze is a function that performs low temperature heating operation to prevent freezing of water lines and equipment, when air conditioning operation is off, in regions where outside temperature may drop below freezing.

If water lines are far from the unit or within exterior walls, this function may not provide enough anti freeze protection.

#### • Human Sensor Setting\* (for administrator):

"Human Sensor" detects the absence of a person in the room and performs the following energy saving operation. For details of "Human Sensor", refer to indoor unit operating manual.

#### [Auto Saving]

When the absence continues for the set time, the operation switches to energy saving operation.

#### [Auto Off]

When the absence continues for the set time, indoor unit operation stops.

## 3-5-3 Day Off Setting

Set the day of the week of which Weekly Timer is to be temporarily disabled. When the set day has passed, the setting is cleared.

- Touch the [Day Off Setting] on the "Weekly Timer Setting" screen.
- "Day Off Setting" screen is displayed. When the day of the week of which Weekly Timer is not to be performed is touched, a check mark is displayed.

- Fan Control for Energy Saving\* (for administrator):  
When the set temperature is reached during cooling operation, the fan operates intermittently and power is saved.

When the item to be set is touched, the display switches to each setting screen. When each setting is complete or canceled, the display returns to this screen. When [Back] is touched, the display returns to the "Main Menu" screen.

### 3-6-1 Economy

#### On/Off of Economy

- (1) Touch the [Economy] on the "Special Setting" screen.
- (2) "Economy" screen is displayed. Touch the [On] or [Off] on the "Economy" screen.

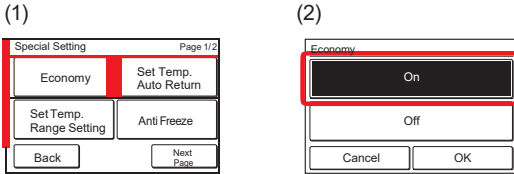

When you touch the [OK], the data is transmitted to the indoor unit, and then the display returns to "Special Setting" screen.

### 3-6-2 Set Temp. Auto Return (for administrator)

- (1) Touch the [Set Temp. Auto Return] on the "Special Setting" screen. When the "Password Verification" screen is displayed, enter the password and touch the [OK].

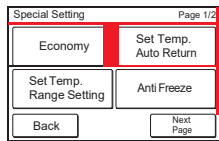

#### Enable the Set Temp. Auto Return

- (2) "Auto Return" screen is displayed. Touch the [Enable/Disable] on the "Set Temp. Auto Return" screen.
- (3) "Enable/Disable" screen is displayed. Touch the [Enable] on the "Enable/Disable" screen.

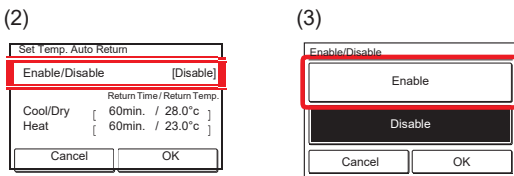

When the [OK] is touched, the display returns to "Set Temp. Auto Return" screen.

#### Set the Return Time and Temperature

- (4) Touch the [Return Time/Return Temp.] on the "Set Temp. Auto Return" screen.
- (5) "Setting" screen is displayed. When the [Cool/Dry] or [Heat] on the "Setting" screen is touched, the time and temperature setting screen is displayed.

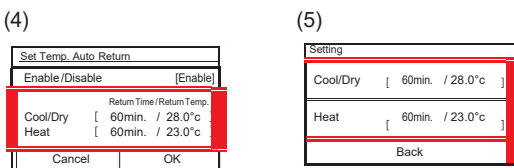

- (6) Set the time and temperature by touching [▲] or [▼]. The time can be set within the 10 to 120 min. range in 10 min. increments.

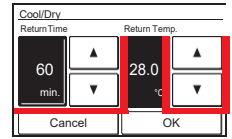

When the [OK] is touched, the display returns to the "Setting" screen.

- (7) When the [Back] is touched, the display returns to the "Set Temp. Auto Return" screen.

#### Apply the setting.

- (8) Touch the [OK] on the "Set Temp. Auto Return" screen. After the setting change screen is displayed, the display returns to the "Special Setting" screen.

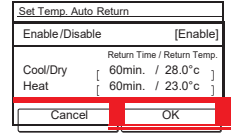

### 3-6-3 Set Temp. Range Setting (for administrator)

- (1) Touch the [Set Temp. Range Setting] on the "Special Setting" screen. When the "Password Verification" screen is displayed, enter the password and touch the [OK].

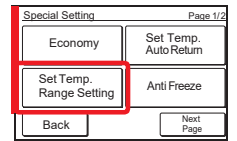

"Set Temp. Range Setting" screen is displayed.

#### Enable the Set Temp. Range Setting

- (2) Touch the [Enable/Disable] on the "Set Temp. Range Setting" screen.
- (3) "Enable/Disable" screen is displayed. Touch the [Enable] on the "Enable/Disable" screen.

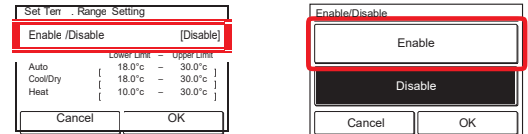

When the [OK] is touched, the display returns to the "Set Temp. Range Setting" screen.

#### Set the Lower Limit and Upper Limit

- (4) Touch the [Lower Limit - Upper Limit] on the "Set Temp. Range Setting" screen.
- (5) "Setting" screen is displayed. Touch the [Auto], [Cool/Dry] or [Heat] on the "Setting" screen.

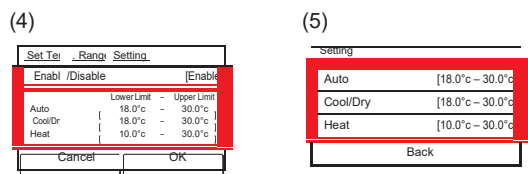

For indoor unit that display [Custom Auto] in the operation mode, set [Cool/Dry] and [Heat]. This setting is reflected in each operation mode of [Custom Auto], [Cool], [Dry] and [Heat].

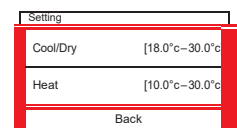

- (6) Each setting screen is displayed. Set the temperature upper limit and lower limit by touching [▲] or [▼].

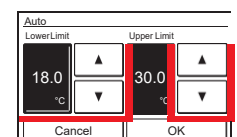



When the [OK] is touched, the display returns to the "Setting" screen. If the [Back] on the "Setting" screen is touched, the display returns to the "Temp. Range Setting" screen.

### Note

The settable upper limit value and lower limit value may be different depending on the indoor unit model, setting at installation and the place of use.

### Apply the setting.

- Touch the [OK] on the "Set Temp. Range Setting" screen. After the setting change screen is displayed, the display returns to the "Special Setting" screen.

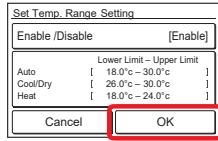

## 3-64 Anti Freeze (for administrator)

- Touch the [Anti Freeze] on the "Special Setting" screen. When the "Password Verification" screen is displayed, enter the password and touch the [OK].

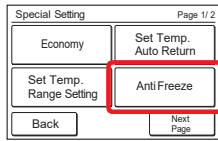

### On/Off of the Anti Freeze

- "Anti Freeze" screen is displayed. Select the [On] or [Off] on the "Anti Freeze" screen.

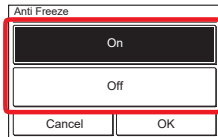

When the [OK] is touched, data transmission is performed and after the setting change screen is displayed, the display returns to the "Special Setting" screen.

## 3-65 Human Sensor Setting (for administrator)

- Touch the [Human Sensor Setting] on the "Special Setting" screen. When the "Password Verification" screen is displayed, enter the password and touch the [OK].
- "Human Sensor Setting" screen is displayed. Touch the [Auto Saving] or [Auto Off] on the "Human Sensor Setting" screen.

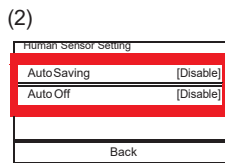
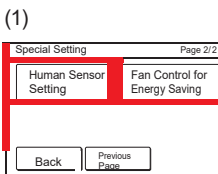

Each setting screen is displayed.

### Setting of the Auto Saving

- Touch the [Auto Saving] on the "Human Sensor Setting" screen. "Auto Saving" screen is displayed. Touch the [Enable/Disable] on the "Auto Saving" screen.
- "Enable/Disable" screen is displayed. Touch the [Enable] on the "Enable/Disable" screen.

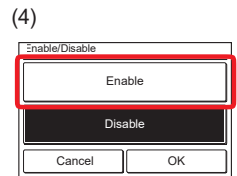
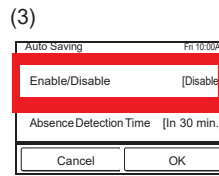

When the [OK] is touched, the display returns to "Auto Saving" screen.

- Touch the [Absence Detection Time] on the "Auto Saving" screen.
- The "Absence Detection Time" screen is displayed. Set the time with [▲] or [▼]. The time can be set to 15, 30, 45, 60, 90, 120 or 180 min.

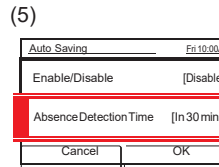

### Note

When detection time the same as or longer than "Auto Off" is set at "Auto Saving", "Auto Saving" does not operate.

When the [OK] is touched, the display returns to the "Auto Saving" screen. And when the [OK] on the "Auto Saving" screen is touched, the display returns to the "Human Sensor Setting" screen.

### Setting of the Auto Off

- Touch the [Auto Off] on the "Human Sensor Setting" screen. "Auto Off" screen is displayed. Touch the [Enable/Disable] on the "Auto Off" screen.
- "Enable/Disable" screen is displayed. Touch the [Enable] on the "Enable/Disable" screen.

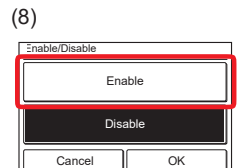
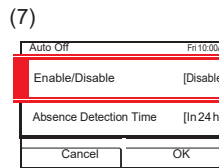

When the [OK] is touched, the display returns to "Auto Off" screen.

- Touch the [Absence Detection Time] on the "Auto Off" screen.
- The "Absence Detection Time" screen is displayed. Set the time with [▲] or [▼]. The time can be set from 1 to 24 hr.

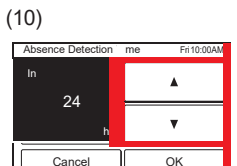
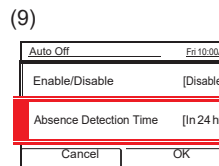

### Note

When detection time the same as or shorter than "Auto Saving" is set at "Auto Off", "Auto Saving" does not operate.

When the [OK] is touched, the display returns to the "Auto Off" screen. And when the [OK] on the "Auto Off" screen is touched, the display returns to the "Human Sensor Setting" screen.

When the [Back] on the “Human Sensor Setting” is touched, the display returns to the “Special Setting” screen.

### 3-6 Fan Control for Energy Saving (for administrator)

- Touch the [Fan Control for Energy Saving] on the “Special Setting” screen. When the “Password Verification” screen is displayed, enter the password and touch the [OK].
- “Fan Control for Energy Saving” screen is displayed. Touch the [Enable] on the “Fan Control for Energy Saving” screen.

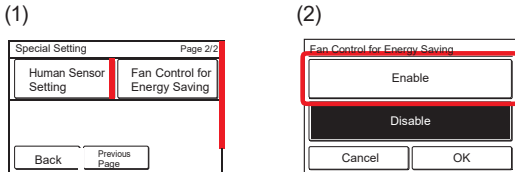

When the [OK] is touched, the display returns to the “Special Setting” screen.

### 3-7 Summer Time (Daylight Saving Time) Setting (for administrator)

The time display and timer operation are 1 hour earlier than usual.

- Touch the [Summer Time Setting] on the “Main Menu” screen.

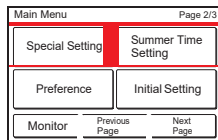

#### Enable or Disable the Summer Time Setting

- “Summer Time Setting” screen is displayed. Select the [Enable] or [Disable] on the “Summer Time Setting” screen.

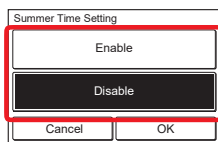

When the [OK] is touched, after the setting change screen is displayed, the display returns to the “Main Menu” screen.

### 3-8 Preference (for administrator)

Settings of the Touch Panel Display

- Touch the [Preference] on the “Main Menu” screen.
- “Preference” screen is displayed.

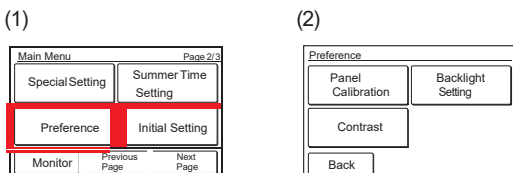

The following contents are set:

- Panel Calibration:**  
When the touched position and the corresponding position does not match on the screen, perform this setting.
- Backlight Setting:**  
Backlight enable/disable, brightness, and off time can be set.
- Contrast:**  
Adjusts the contrast of the screen.

When the item to be set is touched, the display switches to each setting screen. When each setting is complete or canceled, the display returns to this screen. When [Back] is touched, the display returns to the “Main Menu” screen.

### 3-8-1 Panel Calibration

- Touch the [Panel Calibration] on the “Preference” screen.
- “Panel Calibration” screen is displayed. Touch the [Start] on the “Panel Calibration” screen.

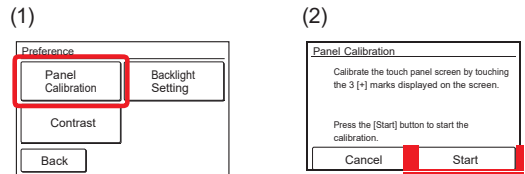

- Touch the center of the [+] mark.
- The [+] mark is displayed at the bottom left side of the screen. Touch the center of this mark.

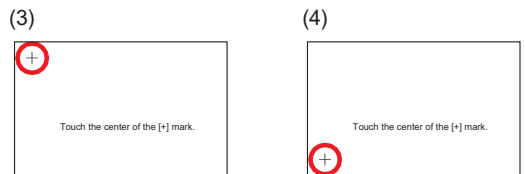

- The [+] mark is displayed at the bottom right side of the screen. Touch the center of this mark.

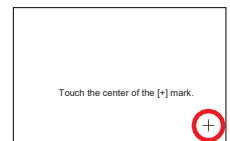

- The [+] marks are sequentially displayed at 3 points on the screen again. Touch the center of each mark.

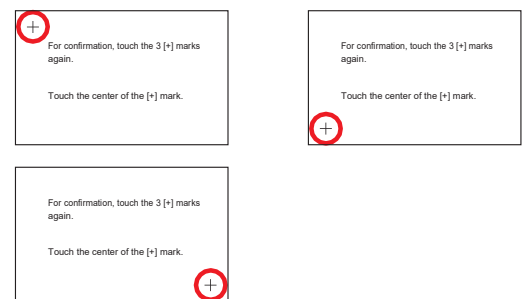

- When calibration was successful, the display returns to the “Preference” screen.

#### If the Panel Calibration has failed

Screen shows that calibration failed. To repeat calibration, touch [Retry] and repeat (2) to (6).

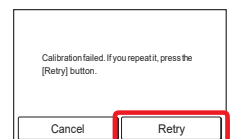

### 3-8-2 Backlight Setting

- Touch the [Backlight Setting] on the "Preference" screen.

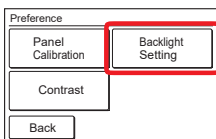

#### Enable or disable the backlight

- "Backlight Setting" screen is displayed. Touch the [Enable/Disable] on the "Backlight Setting" screen.
- "Enable/Disable" screen is displayed. Select the [Enable] or [Disable].

(2)

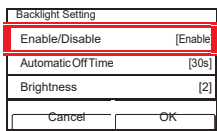

(3)

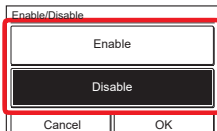

When the [OK] is touched, the display returns to the "Backlight Setting" screen.

#### Note

When set to "Disable", [Automatic Off Time] and [Brightness] setting are unnecessary. (Cannot be set) Go to (8).

#### Set the time until backlight is turned off.

- Touch the [Automatic Off Time] on the "Backlight Setting" screen.
- "Automatic Off Time" screen is displayed. Select the [60 sec.] or [30 sec.].

(4)

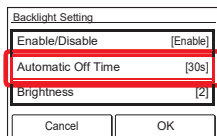

(5)

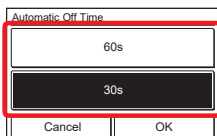

When the [OK] is touched, the display returns to the "Backlight Setting" screen.

#### Adjust the brightness of Backlight

- Touch the [Brightness] on the "Backlight Setting" screen.
- "Brightness" screen is displayed. Adjust the brightness with the [▲] or [▼].

(6)

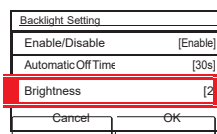

(7)

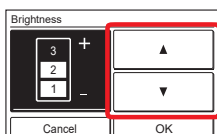

When the [OK] is touched, the display returns to the "Backlight Setting" screen.

#### Apply the setting.

- After setting is complete, touch the [OK] on the "Backlight Setting" screen.

After the setting change is displayed, the display returns to the "Preference" screen.

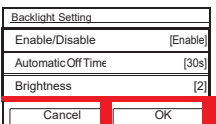

### 3-8-3 Contrast Setting

- Touch the [Contrast Setting] on the "Preference" screen.
- "Contrast Setting" screen is displayed. Adjust the contrast with [▲] or [▼].

(1)

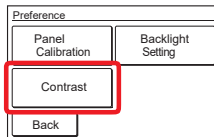

(2)

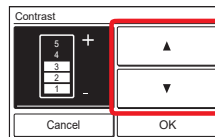

When the [OK] is touched, after the setting change screen is displayed, the display returns to the "Preference" screen.

### 3-9 Initial Setting (for administrator)

Perform this setting at installation. The setting can also be changed after installation.

- Touch the [Initial Setting] on the "Main Menu" screen.
- When "Password Verification" screen is displayed, enter the Password (or Installer Password) and touch [OK].

(1)

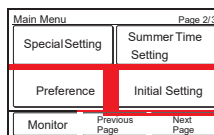

(2)

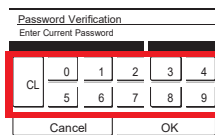

- If the password is entered correctly, the "Initial Setting" screen is displayed. The screen has 3 pages which are switched by touching the [Next Page] or [Previous Page].

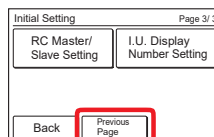
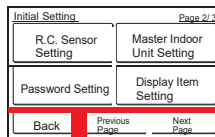
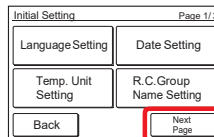

The following contents are set. (♦: for installer)

(\*: Items that indoor unit does not support are not displayed.)

- Language Setting:**  
The displayed language is switched. The displayable languages are English (factory setting), Chinese, French, German, Spanish, Polish, Russian, Italian, Greek, Portuguese, Turkish and Dutch.
- Date Setting:**  
The date and time display format are set. When the power is turned off, the date and time data hold time by built-in battery is approximately 7 days. When the power is turned off for longer than this, the date and time must be reset.
- Temp. Unit Setting:**  
The temperature display unit is switched to "°C" or "°F". Factory settings is "°C".
- R.C.Group Name Setting:**  
The remote controller group name can be set or changed.

- **RC Sensor Setting\*:**  
This setting uses the sensor of this unit to sense the room temperature. The room temperature can be sensed at a position, closer to the person than the indoor unit sensor. Factory settings is "Not Used".
- **Master Indoor Unit Setting:** ◆
- **Password Setting:**  
The password setting and changes can be performed. In addition, password request to the following setting items can be set.
  - On Timer (3-4-1)
  - Off Timer (3-4-2)
  - Auto Off Timer (3-4-3)
  - Weekly Timer (3-5)
  - Set Temp. Auto Return (3-6-2)
  - Set Temp. Range Setting (3-6-3)
  - Anti Freeze\* (3-6-4)
  - Human Sensor Setting\* (3-6-5)
  - Fan Control for Energy Saving\* (3-6-6)
  - Initial Setting (3-9)
  - Maintenance (3-10)
- **Display Item Setting:**  
Display of the Filter sign and Room temp. can be switched between Visible and Invisible.
- **RC Master/Slave Setting** ◆
- **I.U. Display Number Setting\*** ◆

When the item to be set is touched, the display switches to each setting screen. When each setting is complete or canceled, the display returns to this screen. When [Back] is touched, the display returns to the "Main Menu" screen.

### 3-9-1 Language Setting

- (1) Touch the [Language Setting] on the "Initial Setting" screen. "Language Setting" screen is displayed.

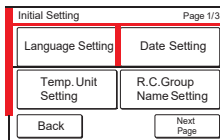

- (2) This screen has 2 pages which are switched by touching the [Next Page] or [Previous Page]. Touch the language to be used.

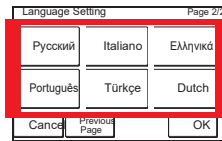
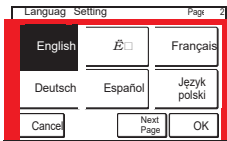

- (3) When the [OK] is touched, after a setting change screen is displayed, the display returns to the "Initial Setting" screen.

### 3-9-2 Date Setting

- (1) Touch the [Date Setting] on the "Initial Setting" screen. "Date Setting" screen is displayed.

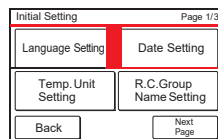

#### Set the Date and Time

- (2) Touch the [Date and Time Setting] on the "Date Setting" screen. "Date and Time Setting" screen is displayed.
- (3) Touch the [Date] on the "Date and Time Setting" screen. "Date" screen is displayed.

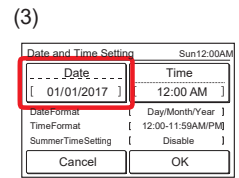
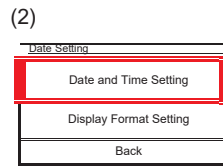

- (4) Set the date by touching [▲] or [▼].  
When the [OK] is touched, the display returns to the "Date and Time Setting" screen.

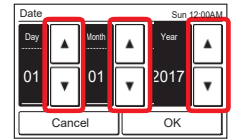

#### Note

Setting screen format corresponds to the preference of the "Display format Setting".

- (5) Touch the [Time] on the "Date and Time Setting" screen.
- (6) "Time" screen is displayed. Set the Time with [▲] or [▼].

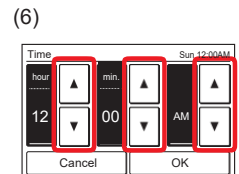
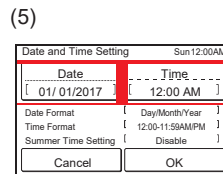

When the [OK] is touched, the display returns to the "Date and Time Setting" screen.

#### Note

Setting screen format corresponds to the preference of the "Display format Setting".

- (7) When the [OK] on the "Date and Time Setting" screen is touched, after a setting change screen is displayed, the display returns to the "Date Setting" screen.

#### Set the Display Format of the Date and Time

- (8) Touch the [Display Format Setting] on the "Date Setting" screen.
- (9) "Display Format Setting" screen is displayed. Touch the [Date Format].

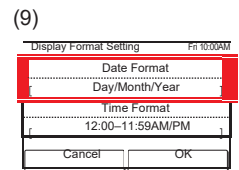
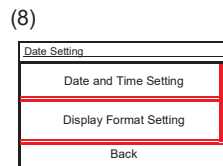

- (10) "Date Format" screen is displayed. Select the desired format.

When the [OK] is touched, after a setting change screen is displayed, the display returns to the "Display Format Setting" screen.

- (11) Touch the [Time Format] on the "Display Format Setting" screen.

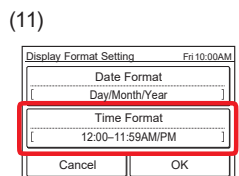
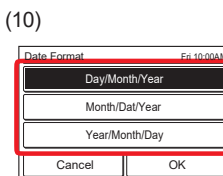

- (12) "Time Format" screen is displayed. Select the desired format.

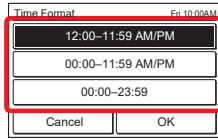

When the [OK] is touched, the display returns to the "Display Format Setting" screen.

- (13) When the [OK] on the "Display Format Setting" screen is touched, after a setting change screen is displayed, the display returns to the "Date setting" screen.

### Quit the Date setting

- (14) When the [Back] on the "Date Setting" screen is touched, the display returns to the "Initial Setting" screen.

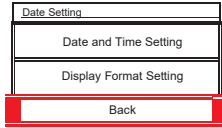

## 3-9-3 Temp. Unit Setting

- (1) Touch the [Temp. Unit Setting] on the "Initial Setting" screen.
- (2) "Temp. Unit Setting" screen is displayed. Select the [°C] or [°F]. (Default is "°C".)

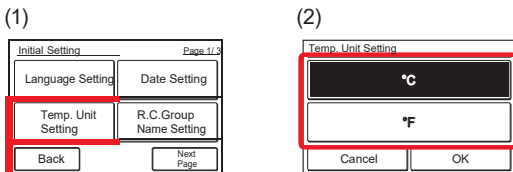

When the [OK] is touched, after a setting change screen is displayed, the display returns to the "Initial Setting" screen.

## 3-9-4 R.C.Group Name Setting

- (1) Touch the [R.C.Group Name Setting] on the "Initial Setting" screen.
- "R.C.Group Name Setting" screen is displayed.

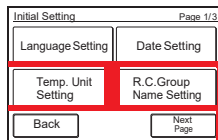

### Description of the screen

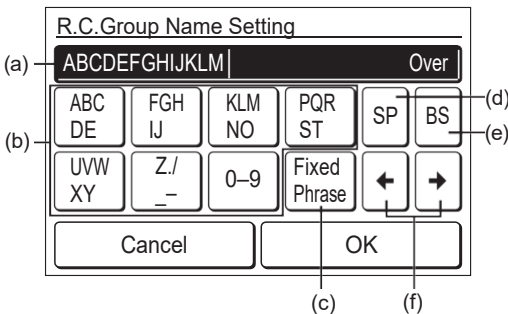

- (a) Input area:  
When the available number of characters is exceeded, "Over" is displayed at the right end. (Alphabet 12 characters, Chinese 8 characters)
- (b) Character keys:  
Touch the same key until the character to be used is displayed.
- (c) Fixed Phrase key:  
[Floor, Corridor, Office, Conf Room, Receipt Room, Room, Room No., Front, Side, Entrance, Outlet, East, West, South, North, Window] is registered. Touch the [Fixed Phrase] key until the sentence to be used is displayed.

- (d) Space key  
(e) Backspace key  
(f) Cursor keys

### Change the R.C. Group Name

- (2) Touch each key and enter the name. When the [OK] is touched, after a setting change screen is displayed, the display returns to the "Initial Setting" screen.

## 3-9-5 R.C. Sensor Setting

- (1) Set the [R.C. Sensor Setting] on the "Initial Setting" screen.
- (2) "R.C. Sensor Setting" screen is displayed. Touch the [Used].

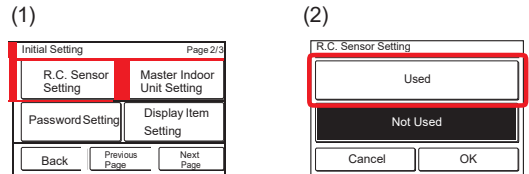

When the [OK] is touched, after the data is transmitted to the indoor unit, the display returns to the "Initial Setting" screen.

## 3-9-6 Password Setting

- (1) Touch the [Password Setting] on the "Initial Setting" screen.

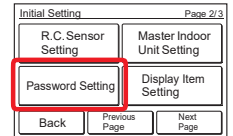

### Change the Password

- (2) "Password Setting" screen is displayed. Touch the [Change Password].
- (3) "Password Verification" screen is displayed. Enter the current password, and touch the [OK].

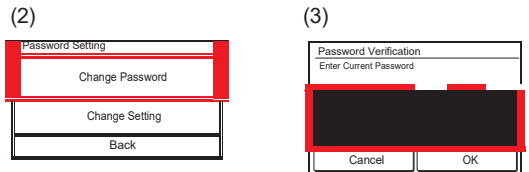

### Note

The default password is "0000" (4 digits).

- (4) If the password is entered correctly, the "Change Password" screen is displayed.

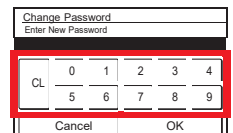

When the new password is entered and the [OK] is touched, after the setting change screen is displayed, the display returns to the "Password Setting" screen.

**Password request to the setting item On/Off is set.**

- (5) Touch the [Change Setting] on the "Password Setting" screen.

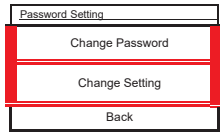

"Change Setting" screen is displayed. The screen has 3 or 4 pages which are switched by touching the [Next Page] or [Previous Page].

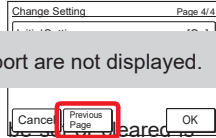
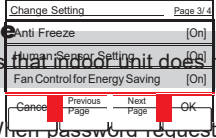
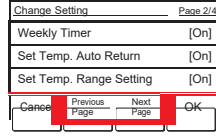
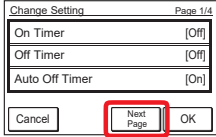

**Note**  
Items that indoor unit does not support are not displayed.

- (6) When password request item to be set is cleared, touched, each setting screen is displayed.

- (7) Touch the [On] or [Off].  
(Example "On Timer" screen)  
When the [OK] is touched, the display returns to the "Change Setting" screen.

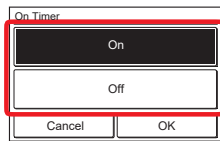

**Apply the setting.**

- (8) When setting is complete, touch the [OK] on the "Change Setting" screen.  
(Example Page 1/4)

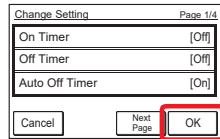

After the setting change screen is displayed, the display returns to the "Password Setting" screen.

- (9) When the [Back] on the "Password Setting" screen is touched, the display returns to the "Initial Setting" screen.

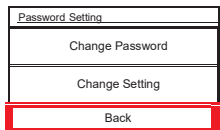

**3-9-7 Display Item Setting**

- (1) Touch the [Display Item Setting] on the "Initial Setting" screen.

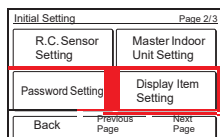

**Filter Sign visible/invisible**

- (2) "Display Item Setting" screen is displayed. Touch the [Filter Sign] on the "Display Item Setting" screen.

- (3) "Filter Sign" screen is displayed. Touch the [Visible] or [Invisible].

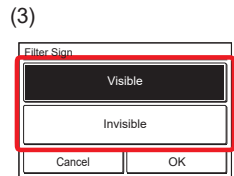
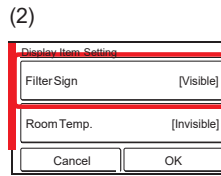

When the [OK] is touched, the display returns to the "Display Item Setting" screen.

**Room Temp. visible/invisible**

- (4) Touch the [Room Temp.] on the "Display Item Setting" screen.
- (5) "Room Temp." screen is displayed. Select the [Visible] or [Invisible].

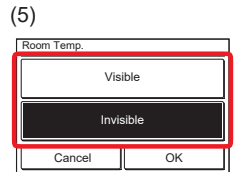
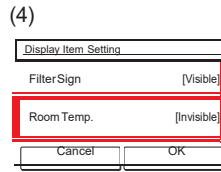

When the [OK] is touched, the display returns to the "Display Item Setting" screen.

**Apply the setting.**

- (6) When the setting is complete, touch the [OK] on the "Display Item Setting" screen.  
After the setting change screen is displayed, the display returns to the "Initial Setting" screen.

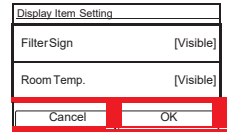

**3-10 Maintenance (for administrator)**

Verification, operation, and setting for administrator information are performed.

- (1) Touch the [Maintenance] on the "Main Menu" screen.
- (2) When "Password Verification" screen is displayed, enter the Password (or Installer Password) and touch [OK].

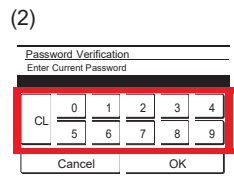
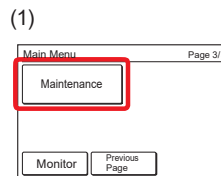

- (3) If the password is entered correctly, the "Maintenance" screen is displayed. The screen has 3 pages which are switched by touching the [Next Page] or [Previous Page].

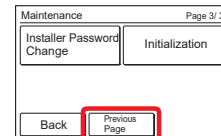
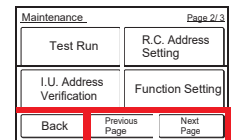
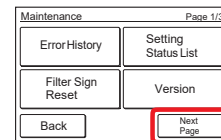

Verification, operation, and setting of the following contents are performed. (♦: for installer)  
 (\*: Items that indoor unit does not support are not displayed.)

- Error History:  
The error history can be verified/cleared.
- Setting Status List:  
The status of each setting can be verified as a list.
- Filter Sign Reset\*:  
After the indoor unit filter is cleaned, the filter sign can be reset.
- Version:  
The software version No. of this unit can be verified.
- Test Run ♦
- R.C. Address Setting ♦
- Indoor Unit Address Verification ♦
- Function Setting ♦
- Installer Password Change ♦
- Initialization ♦

When the [Back] is touched at settings other than initialization, the display returns to the "Main Menu" screen. When initialization is performed, the setting screen at initial starting is displayed.

- (2) "Setting Status List" screen is displayed. The screen has 5 pages which are switched by touching the [Next Page] or [Previous Page]. (Items that indoor unit does not support are not displayed.)

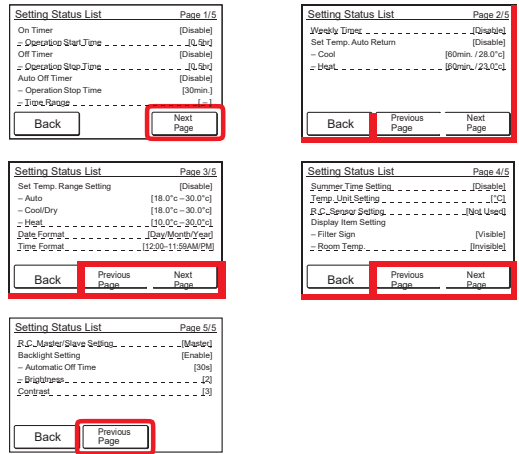

When the [Back] is touched, the display returns to the "Maintenance" screen.

### 3-10-1 Error History

- (1) Touch the [Error History] on the "Maintenance" screen.
- (2) "Error History" screen is displayed. When the screen has multiple pages, they can be switched by touching the [Next Page] or [Previous Page].

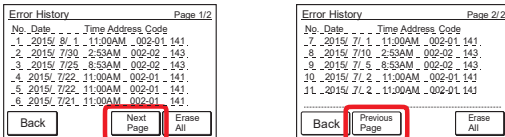
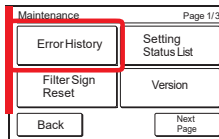

- (3) When the [Back] is touched after verification, the display returns to the "Maintenance" screen.

### Erase the Error History

- (1) Touch the [Erase All] on the "Error History" screen.
- (2) A verification screen is displayed. When the [Yes] is touched after the history is cleared, the display returns to the "Error History" screen.

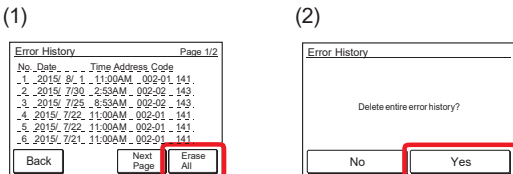

### 3-10-2 Setting Status List

- (1) Touch the [Setting Status List] on the "Maintenance" screen.

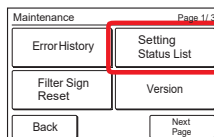

### 3-10-3 Filter Sign Reset

- (1) Touch the [Filter Sign Reset] on the "Maintenance" screen. After the data transmission screen is displayed, the "Filter Sign Reset" screen is displayed.
- (2) When the [OK] is touched, the indoor unit filter sign goes off and the display returns to the "Maintenance" screen.

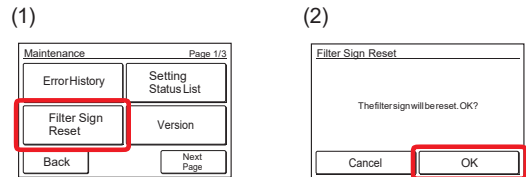

### 3-10-4 Version

- (1) Touch the [Version] on the "Maintenance" screen.
- (2) "Version" screen is displayed. When the [Back] is touched, the display returns to the "Maintenance" screen.

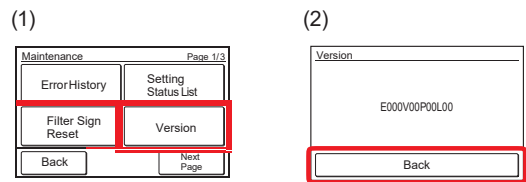

## 4 OPERATION TIPS

### 4-1 Selectable Modes (for VRF system)

There are restrictions on the selectable modes depending on the system configuration and operation status.

#### 4-1-1 Heat recovery system

- (a) When single indoor unit connected to RB unit  
All the modes can be selected.
- (b) When a master indoor unit is set in an RB group, only the mode selected at the master indoor unit (\*1) can be used. (\*1: "Fan" cannot be selected at the indoor unit including the master indoor unit.)
- (c) When a master indoor unit is not set in the RB Group, refer to the following table.

Status	Selectable	Not selectable
Other indoor unit is in cooling operation.	Cool, Dry	Auto or Custom Auto, Heat, Fan
Other indoor unit is in dehumidifying operation.	Cool, Dry	Auto or Custom Auto, Heat, Fan
Other indoor unit is in heating operation.	Heat	Auto or Custom Auto, Cool, Dry, Fan
Other indoor unit is in anti freeze operation.	Heat	Auto or Custom Auto, Cool, Dry, Fan

#### 4-1-2 When indoor units is connected for cooling only in heat recovery system

- (a) Refer to the following table:

Status	Selectable	Not selectable
At any time	Auto or Custom Auto, Cool, Dry, Fan	Heat

#### 4-1-3 RB priority connection in heat recovery system

- (a) For indoor units or RB groups by RB priority connection, refer to the following table:

Status	Selectable	Not selectable
Cooling priority is set by external input.	Cool, Dry	Auto or Custom Auto, Heat, Fan
Heating priority is set by external input.	Heat	Auto or Custom Auto, Cool, Dry, Fan

#### 4-1-4 Heat pump system

- (a) Refer to the following table:

Status	Selectable	Not selectable
Other indoor unit is in cooling operation.	Cool, Dry	Auto or Custom Auto, Heat, Fan
Other indoor unit is in dehumidifying operation.	Cool, Dry	Auto or Custom Auto, Heat, Fan
Other indoor unit is in heating operation.	Heat	Auto or Custom Auto, Cool, Dry, Fan
Other indoor unit is in anti freeze operation.	Heat	Auto or Custom Auto, Cool, Dry, Fan

- (b) When a master indoor unit is set in a refrigerant system, only the mode selected at the master indoor unit (\*2) can be used. (\*2: "Fan" cannot be selected at the indoor unit including the master indoor unit.)

### 4-1-5 Outdoor unit priority connection in heat pump system

- (a) Refer to the following table:

Status	Selectable	Not selectable
Cooling priority is set by external input.	Cool, Dry	Auto or Custom Auto, Heat, Fan
Heating priority is set by external input.	Heat	Auto or Custom Auto, Cool, Dry, Fan

### 4-2 Verification screen when setting is complete

The verification screen which is displayed when a setting is complete is displayed for approximately 3 seconds. When this screen is touched, the display switches to the next screen.

(Example of screen)

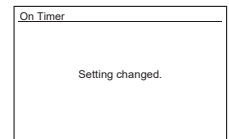

### 4-3 Settable temperature range

The settable temperature range by operation mode and indoor unit setting is shown in the table below.

Cool/Dry*	18 to 30 °C (64 to 88 °F) or 20 to 30 °C (68 to 88 °F)
Heat	VRF system: 10 to 30 °C (48 to 88 °F) Other system: 16 to 30 °C (60 to 88 °F)
Custom Auto	Same as the above range, but there are temperatures that can not be set due to the deadband.
Auto*	18 to 30 °C (64 to 88 °F) or 20 to 30 °C (68 to 88 °F)

#### Note

\* The lower limit of the setting temperature is different depending on the place of use.



## 5 OTHERS

### 5-1 Outline Dimensions

Unit: mm (in)

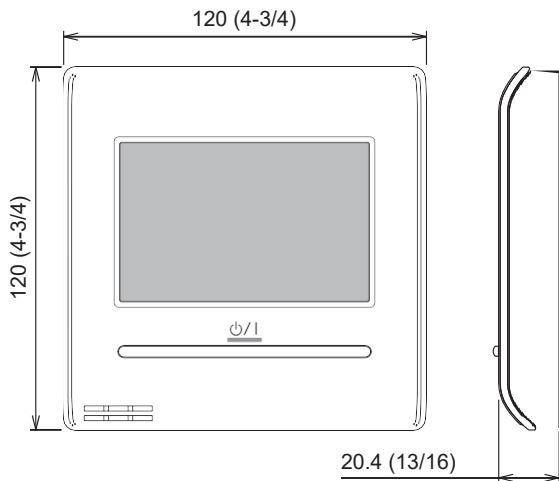

### 5-2 Specifications

Model Name	UTY-RNR*Z3
Input voltage	DC 12 V
Power consumption	Max. 0.3 W
Display	3.8 inch FSTN LCD display (255 × 160 dots) with Touch panel
Usage temperature range	0 to 40 °C (32 to 104 °F)
Usage humidity range	20 to 90 % (no condensation)
Storage temperature range	-10 to 60 °C (14 to 140 °F)
Storage humidity range	20 to 90 % (no condensation)
Dimensions [H × W × D mm (in)]	120 × 120 × 20.4 (4-3/4 × 4-3/4 × 13/16)
Weight [g (oz)]	220 (7.76)

### 5-3 Error Code

For the details of the indoor unit or outdoor unit error when checking the error contents, refer to the error codes in each installation manual.

Error code	Contents
CC.1	Sensor error
C2.1	Transmission PCB error
12.1	Wired remote controller communication error
12.3	Number excess of device in wired remote controller system
12.4	Wired remote controller system start-up error
26.4	Address duplication in wired remote controller system
26.5	Address setting error in wired remote controller system
15.4	Data acquisition error

**FUJITSU GENERAL LIMITED**  
3-3-17, Suenaga, Takatsu-ku, Kawasaki 213-8502, Japan