

FISHER & PAYKEL

CONDENSING DRYER

DE8060P

INSTALLATION GUIDE / USER GUIDE

NZ AU SG ROW

CONTENTS

| | |
|-----------------------------|----|
| Safety and warnings | 5 |
| Installation instructions | 8 |
| Before your first dry | 15 |
| Control panel | 16 |
| Drying cycles | 19 |
| Dry preparation | 20 |
| Getting started quickly | 23 |
| Drying options | 25 |
| Customising drying cycle | 28 |
| Caring for your dryer | 30 |
| Before you call for service | 35 |
| Fault codes | 36 |
| Troubleshooting | 37 |
| Manufacturer's Warranty | 43 |
| Customer care | 45 |

Registration

To register your product visit our website: fisherpaykel.com/register

SAFETY AND WARNINGS

Meaning of symbols on the dryer



Warning: Risk of fire/Flammable materials



Read the instructions

WARNING!



Fire Hazard

- Only dry fabrics that have been washed with water.
- Do not use heat to dry articles containing foam rubber or similarly textured rubber-like materials, dry on **COOL AIR**.
- Never stop a tumble clothes dryer before the end of the drying cycle unless all items are removed and spread out in order to dissipate the heat.
- A clothes dryer produces combustible lint; the lint filter must be cleaned before each drying cycle.
- Failure to follow the warnings outlined in this guide can cause a fire hazard.
- Failure to follow this guide can result in death or personal injury.

READ AND SAVE THIS GUIDE

- The appliance must not be supplied through an external switching device, such as a timer, or connected to a circuit that is regularly switched on and off by a utility.
- We do not recommend the use of extension cords or portable electrical outlet devices for safety reasons.
- Do not touch or operate the machine with wet hands or with bare-feet.
- A damaged power cord must be replaced by a Fisher & Paykel trained and supported service technician or similarly qualified persons in order to avoid a hazard. The appliance must not be operated until it is repaired, as there is risk of electric shock.
- Do not operate this machine if it has been damaged during transport. Contact your Fisher & Paykel dealer or Fisher & Paykel trained and supported service technician.

When using this appliance always exercise basic safety precautions including the following:

Dryer use

- This dryer has been designed for domestic use only, not for commercial applications, such as massage/beauty clinics where there may be increased lint accumulation or flammable materials in the atmosphere or load.
- This dryer is not intended for use by persons (including children) with reduced physical, sensory or mental capabilities, or lack of experience and knowledge, unless given supervision or instruction concerning the use of the dryer by a person responsible for their safety.

SAFETY AND WARNINGS

- Children should be supervised to ensure they do not play with the dryer.
- The tumble dryer is intended only for drying textile material washed in water.
- Undergarments that contain metal reinforcements should not be placed in the dryer. Damage to the dryer can result if the metal reinforcements come loose during drying. If you wish to dry these items use a drying rack or place in a garment bag.
- Check and remove all objects from pockets, eg lighters and matches.
- Unplug the machine from the power supply when it is not in use.
- Do not swing on or put weight on the door.
- Clothes should go through the cool down/airing phase in the final part of the cycle. This ensures items are left at a temperature where they will not be damaged. If for any reason the dryer is stopped before the cycle has finished, dry clothes should be removed immediately and not left in the dryer. Clothes should be quickly spread out flat to cool so heat can dissipate, not left bunched up, eg in a clothes basket.
- Your dryer is designed to stop operating in the event of power outage. When power is resumed, the machine will remain off until the POWER button is pressed. To restart the dryer, press POWER, select your drying cycle and touch ►||.
- Never put dripping wet clothes in or on top of the dryer as excess water may cause an electrical hazard.
- Do not under any circumstances dry an electric blanket or any other electrical, plastic or rubber items in your dryer, unless the care label specifically states it is safe to do so. Never dry these items at high temperatures.
- Do not dry curtains in your dryer. Sunlight makes them brittle and they may disintegrate during drying.
- Do not use the water collected in the water tank for drinking or food processing.
- Never run the dryer without the water tank in place.
- If the water tank becomes full, the tumble dryer will pause drying and will sound an alarm. You must empty the water tank before the dryer can continue drying. Empty the tank, replace it back in the housing then touch ►|| to resume the cycle.
- Do not overload your dryer beyond its rated capacity.

| MODEL CODE | MAXIMUM CAPACITY* (KG) |
|------------|------------------------|
| DE8060P | 8 |

*Capacity refers to the maximum **dry** weight of items the machine can dry at any one time. Some cycles have a lower maximum capacity (refer to 'Drying cycles').

Installation

- The dryer must be installed in a well-ventilated, dust-free environment.
- The dryer must not be installed on any textured floor coverings (eg carpet, rugs) to ensure that openings at the base of the machine are not obstructed.
- Do not install the dryer behind a lockable door, sliding door, or behind a door where the hinge is on the opposite side to that of the dryer in such a way that the full opening of the door is inhibited. Ensure the dryer door can always be opened fully.
- Refer to the installation section of this document for detailed installation steps.

Servicing

- Never attempt to repair the dryer yourself.
- The only user-removable parts of the dryer are the lint filter, condenser filter, drying rack. No other parts are designed to be removed by anyone other than a Fisher & Paykel trained and supported service technician.
- For problems that cannot be solved from information in this user guide, turn off and unplug your dryer and contact a Fisher & Paykel trained and supported service technician.

SAFETY AND WARNINGS

Lint

- Clean the lint filter before every load.
- Accumulated lint in the dryer can become a fire hazard; it also reduces the efficiency of the dryer by causing longer drying times and increased power consumption.
- Ensure the area around the dryer is clear of lint.
- At regular intervals have the interior of the dryer cleaned of any accumulated lint. This must be done by a Fisher & Paykel trained and supported service technician. This must be done when the dryer installation is changed from free standing.
- If the lint filter becomes damaged, contact your Fisher & Paykel trained and supported service technician to arrange getting a new filter.
- Do not operate this product without the lint filter in place or allow lint to accumulate in or around the dryer.

Spontaneous combustion

To reduce the risk of fire in a tumble dryer the following should be observed:

- Items that have been spotted or soaked with vegetable oil or cooking oil are a fire hazard and should not be placed in a tumble dryer.
- Oil-affected items can ignite spontaneously, especially when exposed to heat sources such as a tumble dryer. The items become warm causing an oxidation reaction in the oil. This oxidation creates heat. If the heat cannot escape the items can become hot enough to catch fire. Piling, stacking or storing oil-affected items can prevent heat from escaping creating a fire hazard.
- If it is unavoidable that fabrics that contain vegetable oil, cooking oil or have been contaminated by hair care products be placed in a tumble dryer, they should first be washed in hot water with extra detergent – this will reduce, but not eliminate the fire hazard. The cool down cycle of the dryer should be used to reduce the temperature of these items. They should not be removed from the tumble dryer and piled or stacked while hot.
- Items that have previously been cleaned in, washed in, soaked in or spotted with flammable liquids or solids, eg petrol/gasoline, kerosene, dry cleaning solvents, vegetable or cooking oil, acetone, denatured alcohol, some brands of spot removers, turpentine, waxes and wax removers or other flammable or explosive substances should not be placed in a tumble dryer.
- Do not dry unwashed items in the tumble dryer.
- The dryer is not to be used if industrial chemicals have been used for cleaning.
- Fabric softeners or similar products should not be used in a tumble dryer to eliminate the effects of static electricity, unless this practice is specifically recommended by the manufacturer of the fabric softener product.
- When choosing to tumble dry a duvet/doona use low-medium heat only and make sure the drum is not overloaded due to the risk of overheating and scorching.
- Exhaust air must not be discharged into a flue which is used for exhausting fumes from appliances burning gas or other fuels.

Disposal

Extreme care must be taken when disposing of your old appliance to avoid hazards.

- When disposing of the dryer, it is recommended that the door is removed to avoid children getting trapped inside, and the electrical cable is cut off close to the dryer.

INSTALLATION INSTRUCTIONS

Read and follow the safety and warnings and this Installation section carefully before using your dryer.

Moving your appliance

When moving your dryer only tip towards the right-hand side (when viewed from the front). If the dryer has not been transported as described, leave it standing upright for at least one hour before turning on.

Accessories

Check you received the following accessories with your Fisher & Paykel dryer, you will find them inside the drum:

- 1 x Drying rack
- 1 x Drain hose
- 1 x Installation guide/user guide

Unpacking

Your dryer is heavy, we recommend two people to remove the packaging.

To ensure the best performance from your new dryer please follow the steps below before using your dryer.

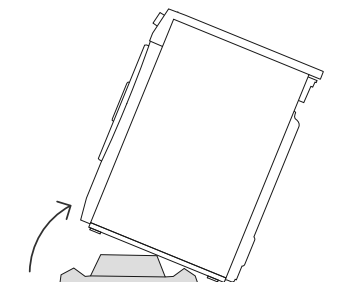

- ① Remove the outer packaging including the polystyrene packer and plastic wrapping.
- ② Lift the dryer off the base.
- ③ Remove all packaging and accessories from inside the drum.
- ④ Dispose of all packaging sustainably, ensuring these materials are kept out of the reach of children.

INSTALLATION INSTRUCTIONS

Product dimensions

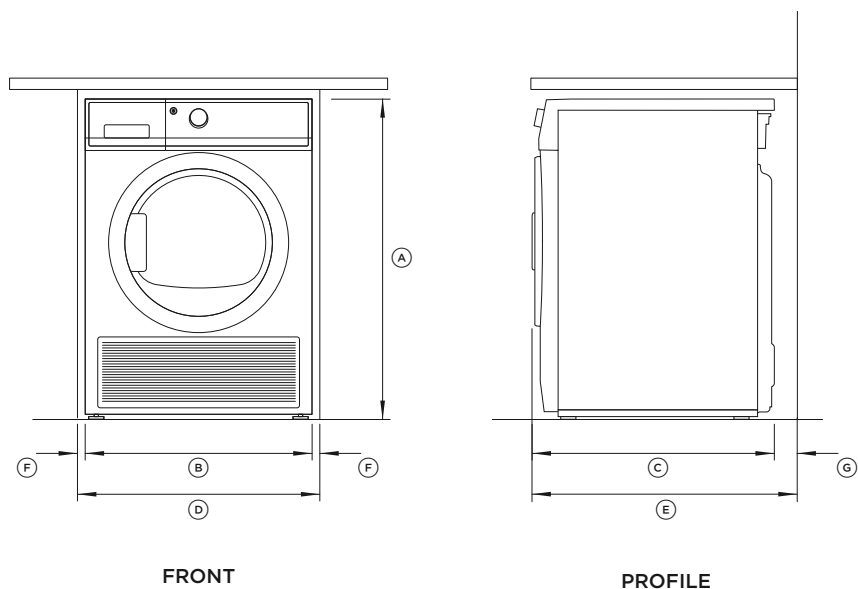

FRONT

PROFILE

| PRODUCT DIMENSIONS | MM |
|--|-----------|
| Ⓐ Overall height of product** | 850 |
| Ⓑ Overall width of product | 600 |
| Ⓒ Overall depth of product | 645 |
| Length of drain hose | 1300 |
| MINIMUM CLEARANCES | MM |
| Ⓓ Minimum cavity width | 640 |
| Ⓔ Minimum depth clearance (incl. inlet hoses and drain hose) | 695 |
| Ⓕ Minimum clearance to wall or adjacent product# | 20 |
| Ⓖ Minimum clearance at the rear of the product | 50 |

*The exact height of your dryer is dependent on how far the feet are extended from the base of the machine.

#Applies either side.

INSTALLATION INSTRUCTIONS

Installation options

This dryer **CANNOT BE INVERTED AND MOUNTED ON THE WALL.**

Your dryer can be installed one of two ways, either freestanding, or stacked on top of a Fisher & Paykel front loading washer (specific models only).

Free standing

The dryer stands on the floor and can easily be moved into position.

Stacking

Your dryer has been designed to be able to be stacked on top of a Fisher & Paykel WashSmart™ or QuickSmart™ front loading washer (WH8560P, WH8060P and WH8560J models only). **A stacking kit MUST BE USED between the products and fitted correctly to the washing machine.**

- Stacking Kit White: Part No. 427976.

Installation requirements

- Minimum clearances on all sides of at least 20mm.
- Stable and level floor (if not stacking on top of a front loading washer).
- Dryer door can be fully opened.
- Dryer is installed inside, in a dry place, with no risk of rain or freezing, not in direct sunlight or close to a source of heat.
- Dryer is not on top of its power cable.

INSTALLATION INSTRUCTIONS

Levelling the Dryer

It is **IMPORTANT** to level the dryer to ensure the machine runs efficiently with minimal noise. The dryer should be levelled in as close to its final position as possible so it stands balanced evenly on all four feet. Ensure the dryer does not rock in any direction.

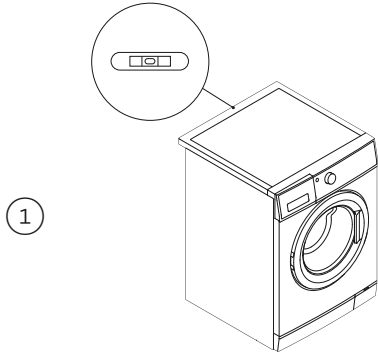

Level the dryer side to side:

- Place the level at the centre back of the dryer.
- Adjust the rear feet until the dryer is level side to side.
- Never unscrew the feet completely from their housings.

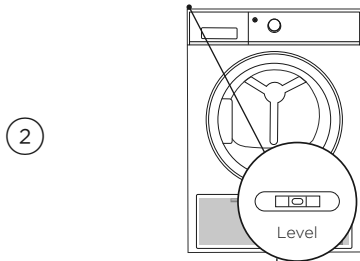

Level the dryer front to back:

- Place the level on the left side.
- Adjust the front left foot (wind down).
- Repeat the above for the right foot.
- There should be equal weight on both front feet.

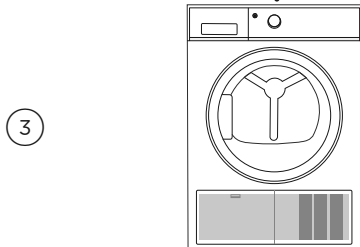

Re-check the dryer is level:

- Place the level at the centre front of the dryer
- Ensure dryer does not rock in any direction.
- If dryer is not level repeat the above steps.

After levelling, the corners of the dryer cabinet should be clear of the floor and the dryer must not rock in any direction.

INSTALLATION INSTRUCTIONS

Draining

The dryer is equipped with a condenser unit which accumulates water during the drying cycle. This water is collected in the removable water tank located at the top left of the dryer. The accumulated water must be emptied after each drying cycle or you can set up your dryer to drain automatically using the drain hose provided.

We recommend the dryer is set up to drain automatically where possible especially when drying full loads, this will avoid having to empty the water tank during a drying cycle.

Connecting the drain hose

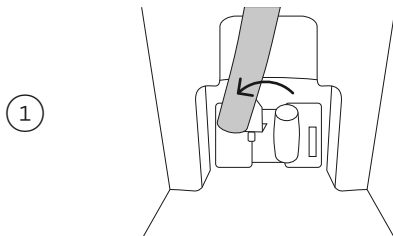

Remove the black hose from the connection at the back of the dryer and place it on the other connection to the left.

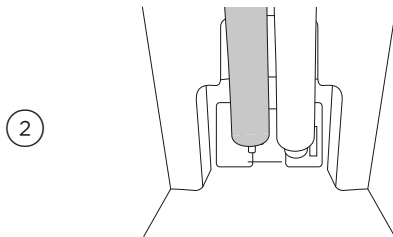

Uncoil the white drain hose and connect it to the back of the dryer where the black drain hose was previously connected.

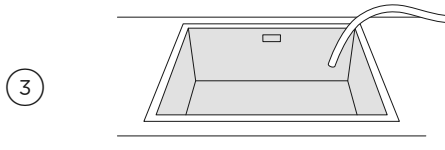

Place the other end of the white drain hose into a tub or standpipe. The connection between the dryer and the white drain hose must be secured to avoid a potential flood.

INSTALLATION INSTRUCTIONS

If you connect the white drain hose onto your dryer and you do not secure the other end in a drain, your dryer will drain water onto your floor. Ensure the drain hose is securely fixed in place to an appropriate drain and is leak-free at the connection to the machine.

- Regularly check that your standpipe or tub is free from lint and other obstructions, which may affect drainage and cause flooding.
- The drain hose should be checked from time to time and replaced if any damage, eg wear, cuts, bulges, kinks, leaks, etc are found. Do not bend the drain hose sharply, as this may cause it to split.
- The extended length of the provided drain hose is 1.3m.
- In multi-storey apartments or any upper floor, the machine should be installed on a floor equipped with a drain.
- Draining must comply with local by-laws.

Electrical connection

- This appliance must be connected to a 220V – 240V, 50Hz, sinusoidal, 10A electrical supply.
- Uncoil the power cord, remove and discard the plastic pin cover and plug into a power socket.
- Connect the appliance to an earthed outlet protected by a fuse of suitable capacity.
- Check the power cord for damage and make sure it is not squashed or twisted when installing the dryer.
- Always remove the power cord from the power socket by the plug, not by the cord.

| ELECTRICAL | |
|-------------------|-----------|
| Volts | 220 – 240 |
| Hz | 50 |
| Amps (maximum) | 10 |
| Heating Power (W) | 1800 |

| SPARE PARTS* | PART NO. |
|---------------------|-----------------|
| Drain hose | H0020300480Q |

*Available from your Fisher & Paykel dealer or a Fisher & Paykel trained and supported service technician.

INSTALLATION INSTRUCTIONS

Completing the installation

Test cycle

Ensure the test cycle is completed before you dry any items in your dryer. The test cycle is to check that your dryer is installed correctly and that it is functioning properly prior to use.

1



Press **POWER** ① to activate your dryer.

2



Select the **TIME DRY 30** cycle. Ensure the drum is empty and the door is closed (you will hear it click shut).

3



Touch ►||, the drum will start rotating.

Observe the dryer for any problems.

The dryer will beep and display any faults on the screen if there are any problems, refer to 'Before you call for service', 'User warnings'.

At the completion of the cycle, open the door and check that there is warmth inside the dryer. This indicates the dryer is operating normally.

If there are any problems, you must address these before proceeding with normal use. The dryer will automatically turn off at the end of the cycle if there are no problems.

BEFORE YOUR FIRST DRY

Check you have done everything you need to before you start your first wash:

- Has the basepacker been removed?
- Is the dryer correctly levelled, and are the cabinet corners clear of the floor and walls?
- If external draining is preferred, is the drain hose attached to the correct outlet and hooked into a standpipe or tub?
- Are the water tank, condenser filter, foam filter and lint filter correctly in place?
- Has the power cord been connected to an appropriate power supply and the power turned on?
- Have you performed the test cycle (see previous page)?

CONTROL PANEL

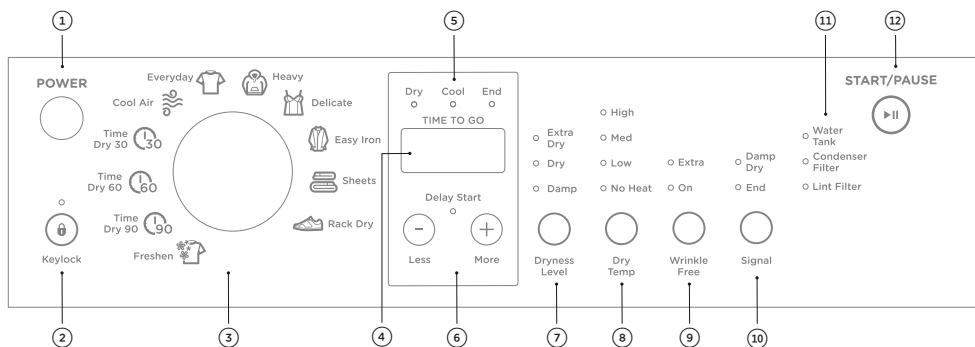

| | |
|---|--|
| ① POWER | Press to turn the dryer ON/OFF. |
| ② Keylock | Touch to disable all buttons on the display panel, except POWER button. This prevents accidental button presses. |
| ③ SmartTouch™ control dial | <p>Rotate to select your desired drying cycle.</p> <ul style="list-style-type: none"> The icon illuminates to indicate the selected drying cycle. |
| ④ Digital display screen | <p>Shows the following:</p> <ul style="list-style-type: none"> TIME TO GO - the remaining time in the cycle that is currently running. Delayed start time of dry cycle. Notifications if an error is detected or a warning is necessary. |
| ⑤ Progress lights | The progress lights indicate what part of the cycle the dryer has reached (DRY , COOL or END). All three lights are on at the start of the cycle. The light for the current part of the cycle flashes, and each one goes out as the cycle progresses. |
| ⑥ Delay Start Less/More | Touch MORE + to increase and LESS - to decrease the delay start time. |
| ⑦ Dryness Level | Allows you to select the level of dryness for your load. |
| ⑧ Dry Temp | Allows you to select the drying temperature for your cycle. |
| ⑨ Wrinkle Free | Allows you to select a WRINKLE FREE option for your cycle. |
| ⑩ Signal | <p>This button has two functions:</p> <ul style="list-style-type: none"> Alert you that the dryer has finished. Alert you to remove items once your load reaches the damp dry stage. |
| ⑪ Water Tank, Condenser, Lint Filter | The lights will flash when the dryer is switched on as a reminder to empty the water tank, or clean the condenser and lint filter. The warning light will also flash on and off during the cycle if the filters become blocked. |
| ⑫ START/PAUSE | Touch to start or pause the selected drying cycle. |

CONTROL PANEL

Timed cycles

When a timed cycle is selected the machine dries for the selected time regardless of the level of moisture in the load. It is important to check the items throughout the timed programmes to avoid over drying. Timed cycles are **TIME DRY 30**, **TIME DRY 60** and **TIME DRY 90**.

Airing/Cool down



When the dryer has sensed that the load is dry it will automatically go into an airing or cool down cycle. During **COOL** the drum tumbles and cool air is blown through the clothes. This cools the load to reduce creasing if the clothes are left in the dryer.

Time to go



Your dryer displays approximately how many minutes the cycle you are running has remaining if you have chosen one of the **TIME DRY** cycles. If you have chosen an automatic cycle (ie not **TIME DRY**) the word **AUTO** will appear on the screen until it reaches the cool down phase, at which time the dryer will display how long the cycle has left to go.

A number of factors can influence the overall cycle time, eg the fabric type of garments, load size, the wetness of the load, environmental conditions etc.

CONTROL PANEL

Keylock

Keylock can be used to lock the buttons on your dryer when not in use. This will avoid accidental button pushes.

To turn Keylock ON or OFF:

①



Press  for two seconds.

When activated, the light above the  button is illuminated.

If Keylock is ON and the dryer is turned OFF:

①



If a button is pressed while **KEYLOCK** is activated, the LED above **KEYLOCK** will flash.

To turn your dryer on:

Press **POWER** , then press and hold the **KEYLOCK** two seconds. This will activate the control panel. Dry cycles and options can now be selected.

②













To stop or power OFF your dryer at any time:

Press **POWER** .

DRYING CYCLES

Your dryer has a number of dry cycles, selecting the most appropriate cycle for each load will help ensure you get the best drying result.

All dry cycles default to a recommended drying temperature and dryness level based on the average expected load to be dried.

| CYCLE | DESIGNED FOR | MAX LOAD (KG) | DEFAULT DRYNESS LEVEL* | DEFAULT DRYING TEMP (°C) |
|---|--|---------------|------------------------|--------------------------|
|  Everyday | High-heat cycle for mixed loads | 8 | Dry | High |
|  Heavy | A longer, high-heat cycle for durable garments | 8 | Dry/ Extra Dry | High |
|  Delicate | A low-heat cycle for careful drying of delicate and heat sensitive garments | 4 | Dry | Low |
|  Easy Iron | A medium-heat cycle that leave garments ready to iron with the WRINKLE FREE option automatically selected | 4 | Damp/Dry | Medium |
|  Sheets | High-heat cycle with reversing to reduce tangling for large bedding items | 4 | Dry | High |
|  Rack Dry | A cycle with user selectable drying times that uses the drying rack for items that cannot be tumbled | 3 | n/a | Low |
|  Freshen | A 15 minute cycle with a burst of heat to refresh dry items | 2 | n/a | High |
|  Cool Air | 40 minute tumble with no heat. | 8 | n/a | No Heat |
|  Time Dry 30 | 30 minute timed cycle. | 8 | n/a | High |
|  Time Dry 60 | 60 minute timed cycle. | 8 | n/a | High |
|  Time Dry 90 | 90 minute timed cycle. | 8 | n/a | High |

* Dryness level is only an option on automatic sensing cycles. On **TIME DRY** and the **RACK DRY** cycle, dryness will vary depending on the load and its initial moisture content.

** **EVERYDAY** cycle, **DRY** dryness level and **HIGH** drying temp is the recommended cycle for everyday cotton items.

DRY PREPARATION

Sorting

Sort your garments before placing them into the dryer. Sort into loads of similar items, and loads that will likely take similar times to dry. Heavier items (eg towels, and flannelette sheets) are best dried separately from lightweight items (eg synthetics, polyester-cotton sheets and shirts). This prevents the possibility of some items becoming over-dried whilst others are still damp. It will also help to extend the life of your clothing and linen.

Care labels on garments provide valuable information about the fabric type and how the garment should be dried. Always follow the advice on the garment labels. Only dry items in this dryer that have a care label stating tumble drying is suitable.

Drying your clothes as soon as you remove them from the washer will decrease the chance of wrinkles forming, and dye transfer from coloured items to white items from occurring.

Separate coloured items from white/light items where possible, especially when new. Colour run may be an issue, especially if you intend to delay the start of the drying cycle.

| SPECIFIC ITEM/DRYING REQUIREMENTS | SUGGESTED CYCLE AND OPTIONS | SUGGESTED TEMPERATURE | COMMENTS |
|--|------------------------------------|------------------------------|--|
| Towels | Everyday | High | Towels produce a lot of lint and are best dried on their own. |
| Sheets, pillowcases, duvet/duona covers | Sheets | High | Ensure duvet/duona cover openings are buttoned/domed before placing in the dryer. |
| Bulky items - doonas, duvets, sleeping bags, jackets | Delicate | Low | Only dry one bulky item at a time and place a few knotted towels into the machine at the same time to ensure the bulky item moves around evenly. |
| Shirts, pants, other creasables | Easy Iron | Medium | WRINKLE FREE is automatically selected to help minimise creasing once the drying cycle has finished. |
| Woolens, silks | Rack Dry | n/a | For items that could be damaged if they are tumbled, eg woolens. |
| Delicates, fine fabrics | Delicate or Rack Dry | Low | You can further reduce the dryness level to damp or use RACK DRY for very delicate items. |
| Jeans | Heavy | High | Turn jeans inside out to help maintain their appearance. Dry separately from other items. |
| Shoes, hats, soft toys or other odd shaped items | Rack Dry | n/a | Check on the item regularly throughout the drying cycle. |

DRY PREPARATION

Before you load

- Check pockets for items that could damage your clothes or get caught in the dryer.
- Close zippers, hooks and eyes, and other fastenings (ie fasten the openings of duvet/duona covers), and remove loose bra wires. These may damage both your dryer and your clothes.
- Clothing with screen-printing should be turned inside out to prevent damage to the print.
- Check the lint and condenser filters are clean and the water tank is empty (if the dryer is not set up to drain automatically).

Loading

Garments need to be loaded correctly to minimise creasing and wrinkling, and to ensure the load is dried evenly.

- Allow enough room in the dryer for clothes to tumble freely. Load the dryer in terms of the space the garments take up when dry, rather than when they are wet.
- Shake clothes out and load individually to help items dry evenly and reduce tangling.
- Only dry a sheet load up to a maximum of 4kg in the dryer at one time.
- Dry permanent press garments (business shirts) together on the **EASY IRON** cycle with the **WRINKLE FREE** option on. This will help reduce wrinkling and the need for ironing.
- Hang garments as soon as the drying cycle is complete to reduce the need for ironing.

Drying times

- Drying very small loads is inefficient. Try to dry medium to large loads.
- Heavier items (towels, flannelette sheets) will take longer to dry than light items (synthetics and polyester cotton sheets and shirts).
- Drying times can be reduced by spinning the wash load at the highest spin speed suitable for the load type in your washing machine.
- Check bulky items during the cycle to ensure even drying. Pause the dryer and reposition the item if necessary.

Lint

Some items are lint givers, while others are lint collectors. Always dry lint givers and collectors separately.

| LINT GIVERS | LINT COLLECTORS |
|--------------------|----------------------------|
| Towels | Synthetics eg polar fleece |
| Flannelette sheets | Corduroy |
| | Polyester cottons |

Delicate or easily damaged items (eg woollen or silk garments, nylon stockings, fine fabrics, delicate embroidered fabrics) should be dried separately, using the **DELICATE** cycle, or if you do not want them tumbled use the **RACK DRY** cycle. Sleeping bags and other down items should be dried on the **DELICATE** cycle.

DRY PREPARATION

Drying rack

There are many items that would benefit from being dried on a drying rack. For example items such as sport shoes, soft toys, hats and woollen items that may be damaged if they are tumbled.



The drying rack is installed in your dryer when it leaves the factory.

When you are using the drying rack you must select the **RACK DRY** cycle.

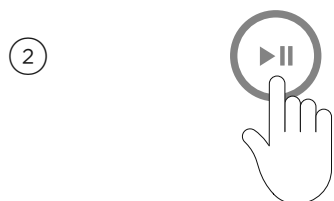

If the rack is not properly installed or if a garment has fallen from it, a user prompt will appear on the digital display screen. Replace the rack and touch ▶|| to resume the cycle.

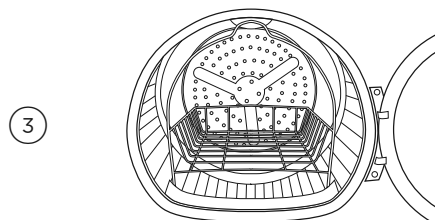

To remove the drying rack, tilt the top of the rack towards you this will detach the legs from the slots in the lint filter, gently remove from the drum.

GETTING STARTED QUICKLY

Check the lint and condenser filters are clean and replaced correctly before every load. Ensure the water tank is empty or drain hose secure before using your dryer.

Sort and load items into the dryer drum, ensuring no items are in the way of the door. Close the door (you will hear it click shut).

1



Press **POWER** ① to activate your dryer.

2



Select your desired drying cycle by turning the SmartTouch™ Control Dial.

3

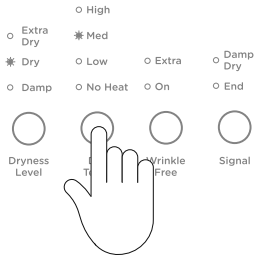

Select your preferred drying options (if you wish to select options different from the default options for the cycle).

If you make an invalid selection the dryer will beep to alert you.

4



Touch ▶|| to start the cycle.

GETTING STARTED QUICKLY

4



If you wish to change a cycle or select a different option once a drying cycle has started, touch ►|| then select the new cycle or option.

Touch ►|| to restart the dryer with the new cycle and/or settings.

When the cycle finishes, your dryer will beep and then turn off automatically. If the **WRINKLE FREE** option has been selected the dryer will rotate the drum periodically blowing cool air into the drum to help minimise wrinkling and creasing of your load.

If you wish to stop the dryer before the cycle has finished you **MUST** remove the clothes **IMMEDIATELY** and spread them out to cool. **DO NOT** leave the clothes in the dryer or bunched up in a clothes basket. Take extreme care as the drum and the load items may be extremely hot.

Failure to follow the advice in this guide may result in damage to your garments and your expectations of drying performance may not be met.

DRYING OPTIONS

All drying cycles default to the recommended options for that cycle based on the average expected load to be dried using that cycle. You can vary the options (eg **DRYNESS LEVEL**, **DRY TEMP**) to create your desired cycle. Some options are not available on some cycles, for clothes care reasons, or because the option is not appropriate for the cycle.



To change a drying option or options you have selected after a cycle has started, touch ►|| and select your new setting, then touch ►|| again to resume the cycle with the new setting or settings.

Dryness Level



When your dryer senses that the clothes have dried to the dryness level selected, the dryer will automatically finish the cycle.

Two lights are used to show some dryness levels, eg to achieve the **DAMP DRY** setting both the **DRY** and the **DAMP** lights will be illuminated.

There are five dryness levels that can be selected from **DAMP** through to **EXTRA DRY**. You can alter the dryness level from the default to suit your load depending on how dry you want your items to be.

Dry Temp

There are four drying temperatures you can choose from for your cycle.

| | |
|----------------|--|
| HIGH | Up to 80°C |
| MEDIUM | Up to 70°C |
| LOW | Up to 60°C |
| NO HEAT | Cool air is blown through the dryer for the period selected. |

DRYING OPTIONS

Wrinkle Free

To minimise wrinkling, select one of the **WRINKLE FREE** options.

- **ON** provides wrinkle free operation for 2 hours.
- **EXTRA** provides wrinkle free operation for 24 hours.

①



To stop the dryer at any point during the **WRINKLE FREE** stage of the cycle, touch **▶||**. You can then open the dryer door and remove your items.

②



Press **POWER** **ⓘ** to turn off your dryer.

Signal

The **SIGNAL** option automatically defaults to on for all cycles.

- Damp
- Dry
- End

①



To turn the **SIGNAL** off press the **SIGNAL** button twice (no lights will illuminate).

- Damp
- Dry
- End

②



To turn the **SIGNAL** on press the **SIGNAL** button once.

DRYING OPTIONS

Delay Start

The **DELAY START** option can delay the start of the dry cycle between 5 minutes and 12 hours.

1

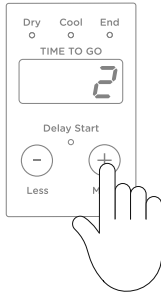

Touch **MORE +** to increase the delay time, and **LESS -** to decrease the time, or turn **DELAY START** off.

2



Touch **▶||** to confirm your selection and start the countdown. The display screen will show the time until the cycle is set to begin.

Avoid using **DELAY START** for damp, non-colourfast items as this may cause dye run to occur. **DELAY START** is not available for a **FRESHEN** cycle.

CUSTOMISING DRYING CYCLE

After using your dryer a few times you may discover there are some drying options you prefer for some cycles. You can programme your dryer to remember the drying options you prefer for each drying cycle. For instance, you may want to set the **EASY IRON** cycle to a lower drying temperature or programme the **EVERYDAY** cycle so it automatically has the **WRINKLE FREE** option selected.

To customise a cycle

1



Press **POWER** ① to activate your dryer.

2

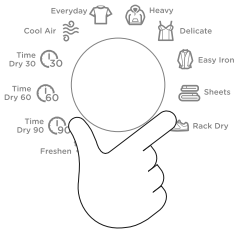

Turn the dial to select the dry cycle you wish to customise.

3

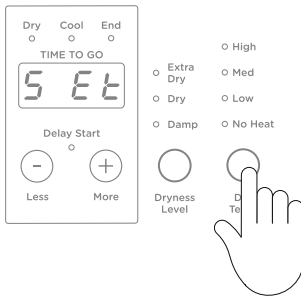

Touch the button of the option you want to customise (eg **DRY TEMP**) for 3 seconds. The lights will flash and the display will show **5 E L** to indicate that the dryer is in option adjustment mode.

CUSTOMISING DRYING CYCLE

4

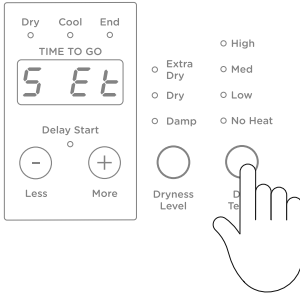

Select your preferred setting for this option, and any other options you wish to customise for this cycle.

5



Touch  to store your customised cycle. A long beep will sound to confirm that your changes have been saved.

To change your customised dry cycle simply repeat these steps.

Reset defaults

You can reset your dryer to the default settings it left the factory with:

1

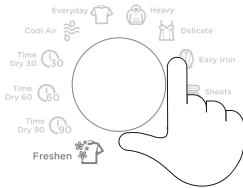

Turn the dial to select the **FRESHEN** cycle.

2

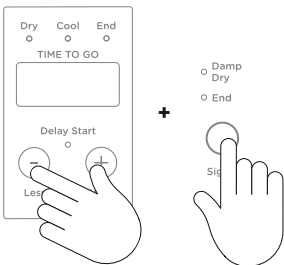

Touch **DELAY START**, **MORE +**, **LESS -** and **SIGNAL** together for 3 seconds.

Your dryer will now be reset to the default settings it left the factory with.

CARING FOR YOUR DRYER

When you have finished using your dryer

- Unplug the dryer from the power socket.
- Wipe around the door to remove any remaining condensation and foreign matter.
- Clear the lint and condenser filters and empty the water tank (if not set up to automatically drain).

Cleaning your dryer

Before you start cleaning your dryer, ensure that it is disconnected from the power (ie unplug the machine from the power socket).

Cleaning the control panel and outer surfaces of the dryer

Use a soft damp cloth to wipe all surfaces, then wipe dry. Avoid using chemical or scouring cleaners, as these will damage the paint and plastic surfaces of your dryer.

Cleaning the inside of your dryer

It is important to occasionally clean the inside of your dryer. If the drum has any residual dirt or lint stuck to it, remove this and wipe it clean with a damp cloth. Do not leave any metal objects in the drum, as these may cause rust.

Cleaning the filters

Lint is generally formed during wearing and washing. Fibres (ie lint) released from the clothes during the drying cycle are collected in the lint filter.

It is important to clean the door lint filter after every load, as the lint produced in the drying process can become a fire hazard if it is allowed to accumulate in or around your dryer.

A warning light will flash at the start of every cycle to remind you to clean the door lint filter, then turns off once you touch ►|| to start your cycle. The warning light will flash on and off during the cycle if the door lint filter becomes blocked. When this occurs the lint filter should be cleaned immediately.

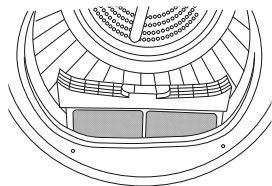

The door lint filter is located in the door opening (at the bottom).

CARING FOR YOUR DRYER

To clean the door lint filter:

1

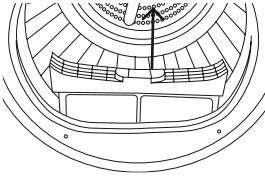

Open the dryer door.

Remove the lint filter by pulling it up and out of the filter slot.

2

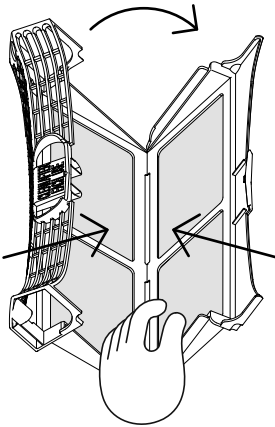

Open it out and wipe the surfaces clean with your hand.

Close the lint filter and place it back in the opening. Ensure the filter is fitted correctly back in place before operating the dryer.

CARING FOR YOUR DRYER

Cleaning the condenser filter

To maintain optimum performance of your dryer the condenser must be cleaned. The condenser filter light will flash when the condenser filter requires cleaning, then turn off once you touch ►|| to start your cycle.

To clean the condenser:

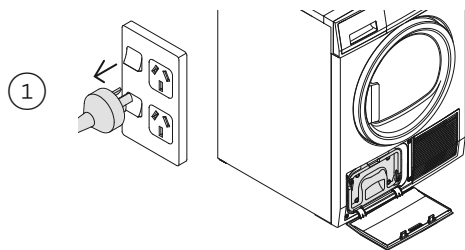

Switch off the power supply and remove the power plug.

Open the condenser filter cover.

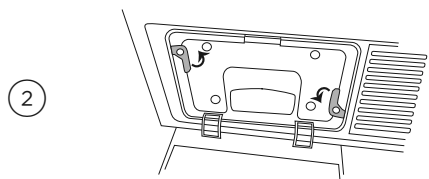

Turn the two condenser lock levers 90° then pull out the condenser filter.

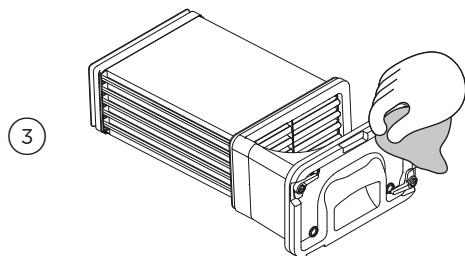

Clean the condenser with pressurised water and wait until the water drains.

Replace the condenser.

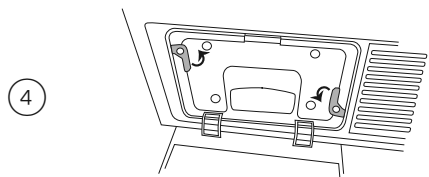

Turn the two condenser lock levers to lock the condenser back in place. Ensure the locks are engaged securely.

Close the condenser cover.

CARING FOR YOUR DRYER

Emptying the water collection tank

During the drying cycle, steam condenses into water and is collected in the water tank, located at the top left of the dryer. It is important to empty the water tank after every load.

If the water tank becomes full during operation, the dryer will pause, display a user prompt and beep to alert you.

To empty the water tank:

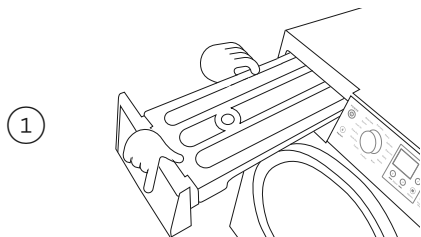

Remove the water tank by holding onto the handle and pulling outwards gently. Ensure the tank is kept level when removed to prevent the water from spilling.

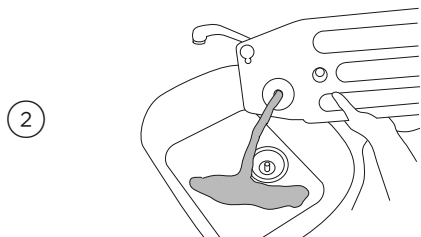

Pour the water down the sink or into a bucket, and then put the tank back in place.

Never run the dryer without the water tank in place unless the drain hose has been installed.

You do not need to empty the water tank if you have set up the drain hose to drain the water automatically.

CARING FOR YOUR DRYER

Cleaning the sensors

There are sensors in your dryer that detect whether the laundry is dry or not. These sensors need to be cleaned periodically (we recommend approximately four times a year).

To clean the sensor:

1

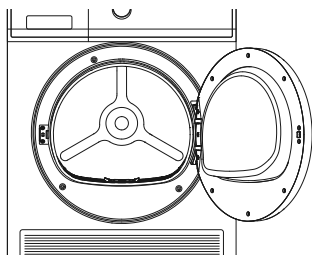

Open the door of your dryer. Allow the dryer to cool if drying has been carried out.

2

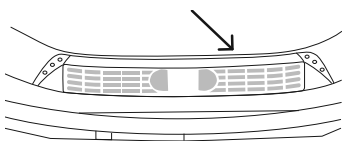

Locate the metal sensors just behind the lint filter.

3

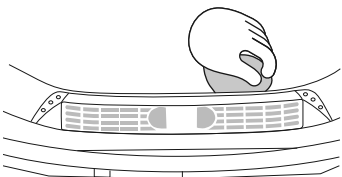



Wipe the sensors with a soft cloth, dampened with vinegar and dry with a clean dry soft cloth.

BEFORE YOU CALL FOR SERVICE

User warnings

Your dryer is capable of diagnosing a number of its own problems. It will sound a continuous series of beeps and display a user prompt when it has a problem that you can correct yourself. To stop the beeps sounding, touch any button on the control panel. Do not try to continue your drying cycle once you stop the noise. You must address the problem the dryer is alerting you to.

Check the below table before you call for service.

| PROBLEM | DISPLAYED AS | WHAT TO DO |
|--|--------------|--|
| Keylock is activated | KEY LOC | Touch  for 2 seconds to deactivate the KEYLOCK. |
| The lint filter is blocked and needs to be emptied | L InE cLn | Empty the lint filter and then replace it. Check the lint filter is not damaged. Check there is nothing else stuck in the lint filter holder which may be blocking the air flow. Check the lint filter is in place correctly in your dryer. |
| The water tank is full and needs to be emptied | H2O FULL | Check if the water tank is full. Empty the water tank. If using the drain hose, check whether the water tank or drain hose is blocked. Check the drain hose is still attached at the back of the machine, and is not kinked or squashed. |
| The condenser needs to be cleaned | cLn cond | Clean the condenser, refer to the 'Cleaning the condenser filter' section). Ensure the condenser unit has been placed or replaced correctly into your dryer. |
| The door is not closed | door OPEN | Close the door fully and touch  . Try opening and closing the door again. Reposition the load, ensure the load is correctly in the drum and that protruding items are not stopping the door from closing. |

Once you have addressed the issue the user prompt was alerting you to, try using your dryer as per usual. If the issue persists, call your Fisher & Paykel trained and supported service technician.

FAULT CODES

When a continuous series of beeps sound, all the lights turn off on the control panel and a number appears on the display, a fault has occurred. The dryer will automatically enter this mode if a fault occurs. The word *FAULT* will be shown in the control panel display followed by a number. To stop the beeps, touch any button then perform the following steps:

- ① Turn your dryer off at the power point.
- ② Wait one minute and turn it back on.
- ③ Check your dryer is installed correctly (refer to 'Installation instructions').
- ④ Remove your load from the dryer and retry.
- ⑤ Perform a **TIME DRY** cycle, eg **TIME DRY 30**.
- ⑥ If the fault re-occurs repeat steps ① and ②.
- ⑦ If the dryer still will not work call a Fisher & Paykel trained and supported service technician to arrange service (refer to 'Customer care'). Record the fault code number displayed and the serial number of your dryer (located on the rear of the dryer, or on the inside of the door below the glass) before calling. The fault code will indicate to the service technician what the problem could potentially be.

If a fault code is being displayed, you can still turn your dryer off by pressing **POWER** ①.

TROUBLESHOOTING

The following is a list of problems you may encounter when using this appliance and some suggestions that may help to correct the problem. If you still have problems, please contact your Fisher & Paykel trained and supported service technician.

| PROBLEM | POSSIBLE CAUSES | WHAT TO DO |
|--|---|--|
| Pressing POWER ⓘ does not turn on the dryer. | Electrical cord not plugged into a power socket. | Plug cord into a power socket. |
| | Power switch not switched on. | Switch power on. |
| | Fault with household power supply. | Try plugging another electrical appliance into the same socket. Turn off the power at the power point. Unplug the dryer from the power socket. Wait 60 seconds, plug it back in, turn it on and try again. |
| Dryer does not heat. | Dryer set to COOL AIR cycle. | Check what cycle the dryer is set to. Refer to 'Drying cycles'. Change to preferred cycle. |
| | Full water tank. | Empty the water tank. Refer to 'Caring for your dryer'. |
| | The dryer has progressed to COOL . | Check the progress lights- are COOL or END lights illuminated? Refer to 'Control panel'. |
| Touching ▶ does not start the drying cycle. | ▶ not touched firmly enough. | Touch ▶ again. |
| | Dryer is paused. | ▶ light will be flashing. Touch ▶ to resume the cycle. |
| | Dryer door not closed properly. | Open and reclose the door. |
| | Is the dryer displaying a user warning or fault code? | Refer to 'User warnings' and 'Fault codes'. |
| | Water tank full or not properly in place. | Empty the water tank. Refer to 'Caring for your dryer'. Ensure the water tank is properly in place. |
| | Lint filter needs to be emptied. | Empty the lint filter and ensure it is correctly in place. |
| | Dryer is overloaded. | Remove some items from the dryer. |
| | DELAY START function is set. | Refer to ' DELAY START ' for more information. |

TROUBLESHOOTING

| PROBLEM | POSSIBLE CAUSES | WHAT TO DO | |
|--|--|---|---|
| Dryer keeps stopping and starting. | The WRINKLE FREE option has been selected. | Refer to 'WRINKLE FREE' for more information. | |
| Dryer stops working mid-cycle. | Power failure. | Press POWER  and restart the desired cycle. | |
| | Dryer has been paused. | Touch the  button to restart the cycle. | |
| | Dryer door is open. | Ensure the door is firmly shut. | |
| Dryer is taking too long/ results were not satisfactory. | Drying cycle selected not appropriate for the load. | Select an appropriate cycle for the load. Refer to 'Drying cycles'. | |
| | Dryness level selected not appropriate for the load. | Select a higher dryness level. Refer to 'Dryness Level'. | |
| | Selected drying temp. not appropriate for the load. | Select a higher drying temp. Refer to 'Dry Temp'. | |
| | Dryer overloaded for the cycle. | | Some cycles have a lower max load size. Refer to 'Drying cycles'. |
| | | | Try dividing the load in half and dry half at a time. |
| | Lint filter is blocked. | Clean the lint filter. | |
| | Condenser is blocked. | Clean the condenser. Refer to 'Cleaning the condenser filter'. | |
| | Water tank is full. | Empty the water tank. Refer to 'Emptying the water collection tank'. | |
| | Environmental conditions may be affecting dryer operation. | In hot, humid conditions the dryer will take longer to dry a load and be less efficient. | |
| | Load overly wet at the start of cycle. | Remove more water from the load before placing it in the dryer, eg select a faster spin speed on your washer, if appropriate for your load. | |
| | Dryer not draining water out properly. | Check the drain hose (if connected) for blockages or damage. You may need to call for service. Refer to 'Customer care'. | |
| Items got wrapped up inside other items. | Try separating items and drying similar items together. Open items out when you place them in the dryer. Do not fold them up. Untangle items, eg pull long sleeves out so they are not stuck/trapped on the inside of the garment. | | |

TROUBLESHOOTING

| PROBLEM | POSSIBLE CAUSES | WHAT TO DO |
|---|--|---|
| Dryer is not draining. | Drain hose not connected to the water tank. | Ensure the drain hose is connected correctly. Refer to 'Draining'. |
| | Water tank not in place correctly. | Ensure water tank is properly in place. |
| | Drain hose or drain blocked or damaged. | Check drain hose (if connected) and drain for blockages or damage. |
| Clothes getting too hot or damaged. | Cycle selected not appropriated for the load. | Ensure the cycle selected is appropriate for items in the load. Refer to pages 'Drying cycles'. |
| | Items removed from dryer before the end of cycle cool down had finished. | Removing items before cool down may damage clothing if it is not spread out and exposed to air to cool once removed from the dryer. |
| Dryer is beeping, displaying unfamiliar light patterns and/ or a message on the digital display. | Dryer is experiencing a fault. | Try turning the dryer off and waiting 1 minute before turning it back on. Refer to 'Before you call for service' and 'Fault codes'. |
| Small puddle of water coming from under the machine. | Water tank not correctly in place. | Ensure the water tank is correctly in place. |
| | Water tank may need to be emptied. | Empty the water tank. |
| | Water tank may be damaged. | Check the water tank for any signs of damage. |
| | Drain hose may not be attached properly at the machine end. | Ensure the drain hose is attached properly. Refer to 'Draining'. |
| | Drain hose could be damaged. | Check the drain hose for damage. |
| | Drain hose has slipped out of the drain. | Ensure the drain hose is securely fixed in place. Sometimes drain hoses can move or get displaced, which may lead to water draining onto the floor. |
| | Drain may be blocked. | Check the drain for any blockages. |
| | Dryer door not closing properly, affecting the seal. | Ensure the dryer door is closed properly and there is nothing obstructing the door opening. |

TROUBLESHOOTING

| PROBLEM | POSSIBLE CAUSES | WHAT TO DO |
|--|--|---|
| Cycle time longer than usual. | Cycle time may be affected by a number of factors and is approximate. | Cycle time is affected by the size and composition of the load, how wet/dry the load was to begin with, the environmental conditions the dryer is operating in, cycle options selected, sensing while drying and any interruptions during the cycle. Refer to 'Sorting'. |
| Small amount of water in the drum at end of cycle. | Water tank needs to be emptied. Environmental conditions may be affecting dryer operation. | Empty the water tank. If conditions are particularly hot and humid, it is possible vaporised water may re-condense in the drum or on the inside of the door. |
| Noises. | Dryer is overloaded. Dryer is experiencing a fault. Beeps signalling the end of a drying cycle. | Remove some items from the dryer. Continuous beeping or a musical series of beeps with a message displayed on digital display. Refer to pages 'Before you call for service' and 'Fault codes'. End of cycle beeps can be turned off. Refer to 'Drying options'. |
| Vibration. | Dryer is not installed on a stable surface. Dryer is not level. Dryer is overloaded. | Ensure the dryer is installed on a flat, stable surface. Refer to 'Levelling the Dryer'. Ensure the dryer is correctly levelled. Refer to 'Levelling the Dryer'. Remove some items from the dryer. |
| Creasing. | Cycle selection not appropriate for the load. Dryer is overloaded. DRYNESS LEVEL selected too high for load type. WRINKLE FREE option not selected. Wet items left sitting in the dryer for a long period before starting the cycle. | Select the EASY IRON cycle to minimise creasing. Remove some items from the dryer. Try selecting a lower DRYNESS LEVEL . Select the WRINKLE FREE option to rotate the load at the end of the drying cycle. Refer to ' WRINKLE FREE '. Try not to leave wet items sitting in the dryer for long periods. |

TROUBLESHOOTING

| PROBLEM | POSSIBLE CAUSES | WHAT TO DO |
|-----------------------|---|--|
| Linting. | Lint filter not cleaned or replaced. | Ensure the lint filter is cleaned after every cycle and replaced correctly. Refer to 'To clean the door lint filter:'. |
| | Dryer is overloaded. | Remove some items from the dryer. |
| | Loads not sorted correctly. | Dry lint givers separately from lint receivers. Also, dry similar colours together eg light coloured items with light coloured items, dark items with dark items. Refer to page 'Drying times'. |
| | Clothes over dried. | Over drying clothes in the dryer can cause them to attract lint. Use an auto sensing cycle or ensure you check your load if using the time dry cycles to avoid over drying. Refer 'Drying cycles'. |
| | New items have been dried in the dryer recently. | New towels or flannelette sheets can leave lint in the dryer, which may be picked up by subsequent loads. |
| Fabric damage. | Delicate items not dried on an appropriate cycle. | Dry delicate items on DELICATE or RACK DRY cycles. Refer pages 'Caring for your dryer' and 'Drying cycles'. |
| | Metal parts on the items or in the load. | Fasten zips and other clasps before placing items in the dryer. |
| | Items not separated or dried on an appropriate cycle for the fabric type. | Dry similar items together. Ensure an appropriate cycle is selected. Refer to page 'Drying cycles'. |
| | Items fell off the rack when using RACK DRY . | Ensure the rack is installed correctly. Refer to 'Sorting', 'Drying rack') and only one or two garments are placed on the rack at a time. |
| | DRYNESS LEVEL selected not appropriate for the fabric type. | Ensure the DRYNESS LEVEL selected is appropriate for the fabric type. Refer to the items care label. Refer to 'Drying cycles' |
| | Used a TIME DRY cycle and did not monitor the dryness of clothes during the cycle. | Ensure that clothes are checked for dryness during the cycle when using the timed programmes to avoid over drying. Refer to 'Timed cycles'. |
| | Instructions on care label not followed. | Follow the instructions on the care label of the items. |

TROUBLESHOOTING

| PROBLEM | POSSIBLE CAUSES | WHAT TO DO |
|----------------------|---|--|
| Dye transfer. | White/ light and coloured items not separated before drying. | Remember to separate white/light and coloured items before placing them in the dryer. |
| | Wet items left sitting in the dryer for long periods of time before drying. | Do not leave wet items sitting in the dryer for long periods of time before drying, if they may be prone to colour run. If you do intend to leave them for long periods before drying, then separate the load and put those items that may cause colour run aside. |
| Tangling. | Loads not separated. | Try separating out larger items from smaller items. |
| | Items loaded into the dryer incorrectly. | Load items individually into the dryer. Do not place folded items in the dryer. |
| | Incorrect cycle selection. | Try using the EASY IRON cycle to dry shirts and the SHEETS cycle to dry sheets. Refer to 'Drying cycles'. |
| | Load size too large. | Try drying smaller load sizes. Some cycles have a lower maximum load size. Refer to 'Drying cycles'. |
| | Delicate items not dried on RACK DRY . | Dry pantyhose, bras, stockings and any other delicate items prone to tangling on the RACK DRY cycle. |
| | Sheets and duvet covers due to their size, are prone to tangling. | Dry sheets and duvet/duona covers separately from other laundry, apart from towels. Ensure duvet/duona covers are buttoned or domed closed before drying. Try adding a knotted towel to sheets loads if you are experiencing a lot of tangling. |

MANUFACTURER'S WARRANTY

For New Zealand and Australia only. You automatically receive a 2 year Manufacturer's Warranty with the purchase of this Condenser clothes dryer covering parts and labour for servicing within the country of purchase.

Fisher & Paykel undertakes to:

Repair or, at its option, replace without cost to the owner either for material or labour any part of the product, the serial number of which appears on the product, which is found to be defective within TWO YEARS of the date of purchase.

Note: this Manufacturer's Warranty is an extra benefit and does not affect your legal rights.

This Manufacturer's Warranty DOES NOT cover

- Ⓐ Service calls which are not related to any defect in the product. The cost of a service call will be charged if the problem is not found to be a product fault. For example:
 - ① Correcting the installation of the product.
 - ② Instructing you how to use the product.
 - ③ Replacing house fuses or correcting house wiring or plumbing.
 - ④ Correcting fault(s) caused by the user.
 - ⑤ Noise or vibration that is considered normal, eg drain/fan sounds, machine noises or user warning beeps.
 - ⑥ Correcting damage caused by pests, eg rats, cockroaches, etc.
 - ⑦ Poor drying performance due to incorrect installation and maintenance eg blocked lint filter, blocked condenser or full water tank.
 - ⑧ Poor drying performance due to incorrect loading, eg overloading or underloading.
 - ⑨ Damage from articles in the drum, eg bra wires, pens, crayons, dye transfer or flammable material.
- Ⓑ Defects caused by factors other than:
 - ① Normal domestic use; or
 - ② Use in accordance with the product's user guide.
- Ⓒ Defects to the product caused by accident, neglect, misuse or 'act of God'.
- Ⓓ The cost of repairs carried out other than by a Fisher & Paykel trained and supported service technician or the cost of correcting such repairs.
- Ⓔ Normal recommended maintenance as set out in the product's user guide.
- Ⓕ Repairs when the appliance has been dismantled, repaired or serviced by other than a Fisher & Paykel trained and supported service technician or the selling dealer.
- Ⓖ Pick-up and delivery.
- Ⓗ Transportation or travelling costs involved in the repair when the product is installed outside the Fisher & Paykel trained and supported service technician's normal service area.

Nothing in this Manufacturer's Warranty is intended to, or does limit, any rights you may have under law to recover the costs of inspecting or returning the goods to us.

MANUFACTURER'S WARRANTY

This product has been designed for use in a normal domestic (residential) environment. This product is not designed for any commercial use (whatsoever). Any commercial use by a customer will affect this product's Manufacturer's Warranty.

Service under this Manufacturer's Warranty must be provided by a Fisher & Paykel trained and supported service technician. Refer to the 'Customer Care' section at the back of this book). Such service shall be provided during normal business hours. This Manufacturer's Warranty certificate should be shown when making any claim.

For Australian Customers

This Manufacturer's Warranty is an extra benefit and does not affect your legal rights. Our goods come with guarantees that cannot be excluded under the Australian Consumer Law. You are entitled to a replacement or refund for a major failure and compensation for any other reasonably foreseeable loss or damage. You are also entitled to have the goods repaired or replaced if the goods fail to be of acceptable quality and the failure does not amount to a major failure.

Please keep this user guide in a safe place.

CUSTOMER CARE

Before you call for service or assistance

Check the things you can do yourself. Refer to your user guide and check:

- ① Your product is correctly installed.
- ② You are familiar with its normal operation.
- ③ You have read the 'Before you call for service', 'Fault codes' and 'Troubleshooting' sections at the back of the book.

If after checking these points you still need assistance or parts, please refer to your nearest Fisher & Paykel trained and supported service technician, Customer Care, or contact us through our website www.fisherpaykel.com.

In New Zealand if you need assistance*

Call the Fisher & Paykel Customer Care Centre and talk to one of our Customer Care Consultants.

Toll Free: 0800 FP CARE or 0800 372 273

Fax: (09) 273 0656

Website: www.fisherpaykel.com

Postal address: Fisher & Paykel Appliances Ltd, PO Box 58550, Botany, Auckland 2163

If you need service*

Fisher & Paykel has a network of Fisher & Paykel trained and supported service technicians that can carry out any service necessary on your appliance. Our Customer Care Centre can recommend a Fisher & Paykel trained and supported service technician in your area.

In Australia if you need assistance*

Call the Fisher & Paykel Customer Care Centre and talk to one of our Customer Care Consultants.

Toll Free: 1300 650 590

Fax: (07) 3826 9298

Website: www.fisherpaykel.com

Postal address: Fisher & Paykel Appliances Australia Pty Ltd, PO Box 798, Cleveland QLD 4163

If you need service*

Fisher & Paykel has a network of Fisher & Paykel trained and supported service technicians that can carry out any service necessary on your appliance. Our Customer Care Centre can recommend a Fisher & Paykel trained and supported service technician in your area.

*If you call, write or contact us via our website please provide: your name and address, model number, serial number, date of purchase and a complete description of the problem. This information is needed in order to better respond to your request for assistance.

Product details can be found on the rear of the dryer, and/or on the inside of the door below the glass (when the door is open).

CUSTOMER CARE

In Singapore if you need assistance*

Call the Fisher & Paykel Customer Care Centre and talk to one of our Customer Care Consultants.

Phone: 6741 0777

Fax: 6547 0123

Website: www.fisherpaykel.com

Postal address: 150 Ubi Avenue 4, Sunlight Building #03-01A, Singapore 408825

*If you call, write or contact us via our website please provide: your name and address, model number, serial number, date of purchase and a complete description of the problem. This information is needed in order to better respond to your request for assistance.

Product details can be found on the rear of the dryer, and/or on the inside of the door below the glass (when the door is open).

Registration

Register your product with us so we can provide you with the best service possible. To register your product visit our website: fisherpaykel.com/register

Complete and keep for safe reference:

Model _____

Serial No. _____

Purchase Date _____

Purchaser _____

Dealer _____

Suburb _____

Town _____

Country _____

FISHERPAYKEL.COM

© Fisher & Paykel Appliances 2020. All rights reserved.

The models shown in this guide may not be available in all markets
and are subject to change at any time.

The product specifications in this guide apply to the specific products and
models described at the date of issue. Under our policy of continuous product
improvement, these specifications may change at any time.

For current details about model and specification availability in your country,
please go to our website or contact your local Fisher & Paykel dealer.

428255A 07.20